



US00D555543S

(12) **United States Design Patent**
Shibata et al.

(10) **Patent No.:** **US D555,543 S**

(45) **Date of Patent:** **** Nov. 20, 2007**

(54) **MOTOR SCOOTER**

D539,706 S * 4/2007 Huang D12/110

(75) Inventors: **Yumio Shibata**, Wako (JP); **Witoon Rerksiriwan**, Bangkok (TH); **Seksith Uchchin**, Bangkok (TH); **Suriya Kwamchob**, Bangkok (TH)

FOREIGN PATENT DOCUMENTS

WO DM/056473 4/2001

* cited by examiner

(73) Assignee: **Honda Motor Co., Ltd.**, Tokyo (JP)

Primary Examiner—Cathron C. Brooks

Assistant Examiner—Linda Brooks

(**) Term: **14 Years**

(74) *Attorney, Agent, or Firm*—Birch, Stewart, Kolasch & Birch, LLP

(21) Appl. No.: **29/266,118**

(57) **CLAIM**

(22) Filed: **Sep. 15, 2006**

The ornamental design for, a motor scooter, as shown and described.

(30) **Foreign Application Priority Data**

Mar. 18, 2006 (JP) 2006-006889

DESCRIPTION

(51) **LOC (8) Cl.** **12-11**

FIG. 1 is a front elevation view of a motor scooter, showing our new design;

(52) **U.S. Cl.** **D12/110**

FIG. 2 is a rear elevation view thereof;

(58) **Field of Classification Search** D12/110;
180/219, 220, 225, 229

FIG. 3 is a top plan view thereof;

See application file for complete search history.

FIG. 4 is a right side elevation view thereof;

FIG. 5 is a left side elevation view thereof;

(56) **References Cited**

U.S. PATENT DOCUMENTS

D443,849 S * 6/2001 Chen D12/110
D480,661 S * 10/2003 Kawawa et al. D12/110
D521,908 S * 5/2006 Hong D12/110
D530,243 S * 10/2006 Lin D12/110
D537,386 S * 2/2007 Mizuta et al. D12/110

FIG. 6 is a first perspective view thereof;

FIG. 7 is a second perspective view thereof;

FIG. 8 is a third perspective view thereof; and

FIG. 9 is a fourth perspective view thereof.

1 Claim, 9 Drawing Sheets

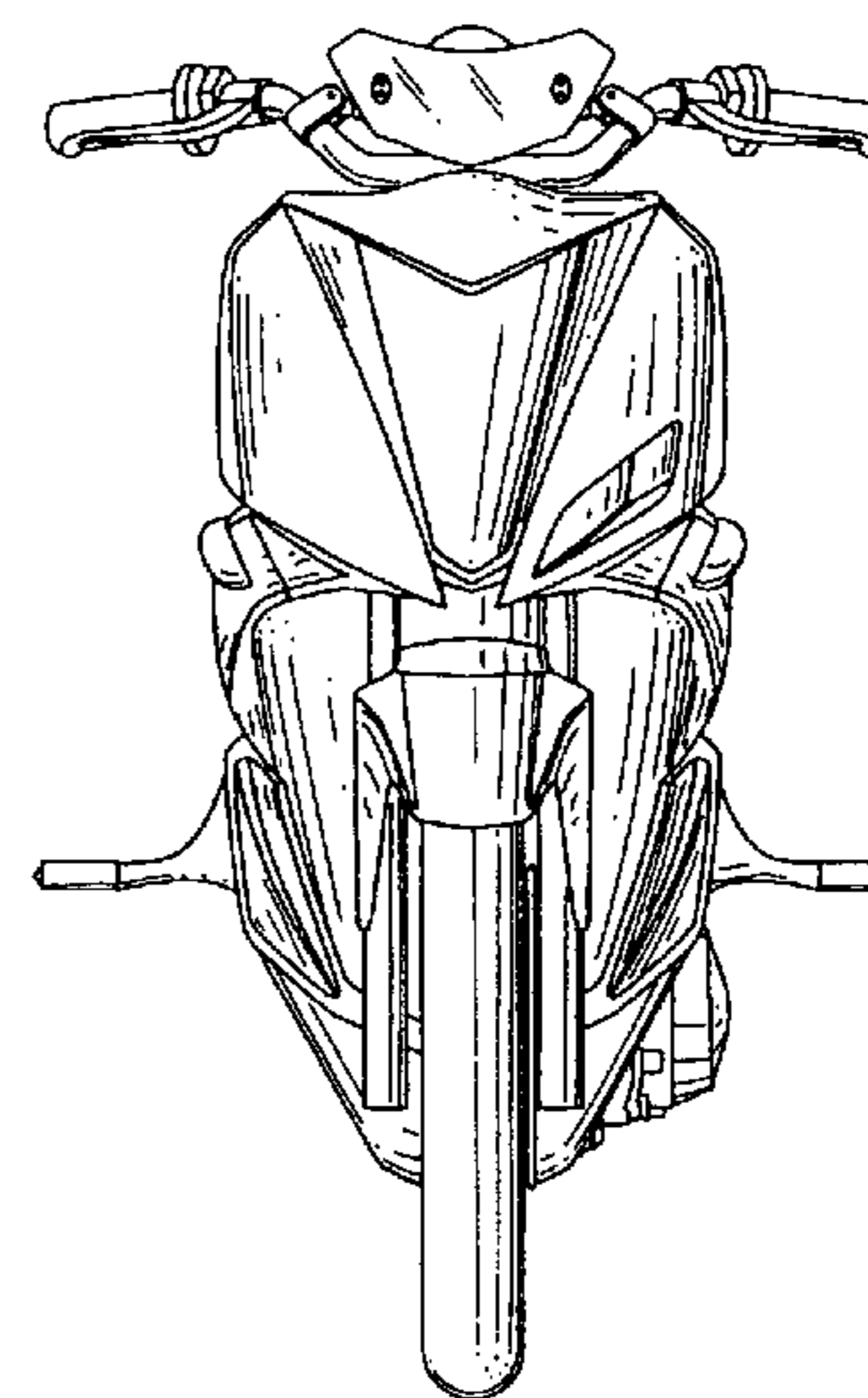
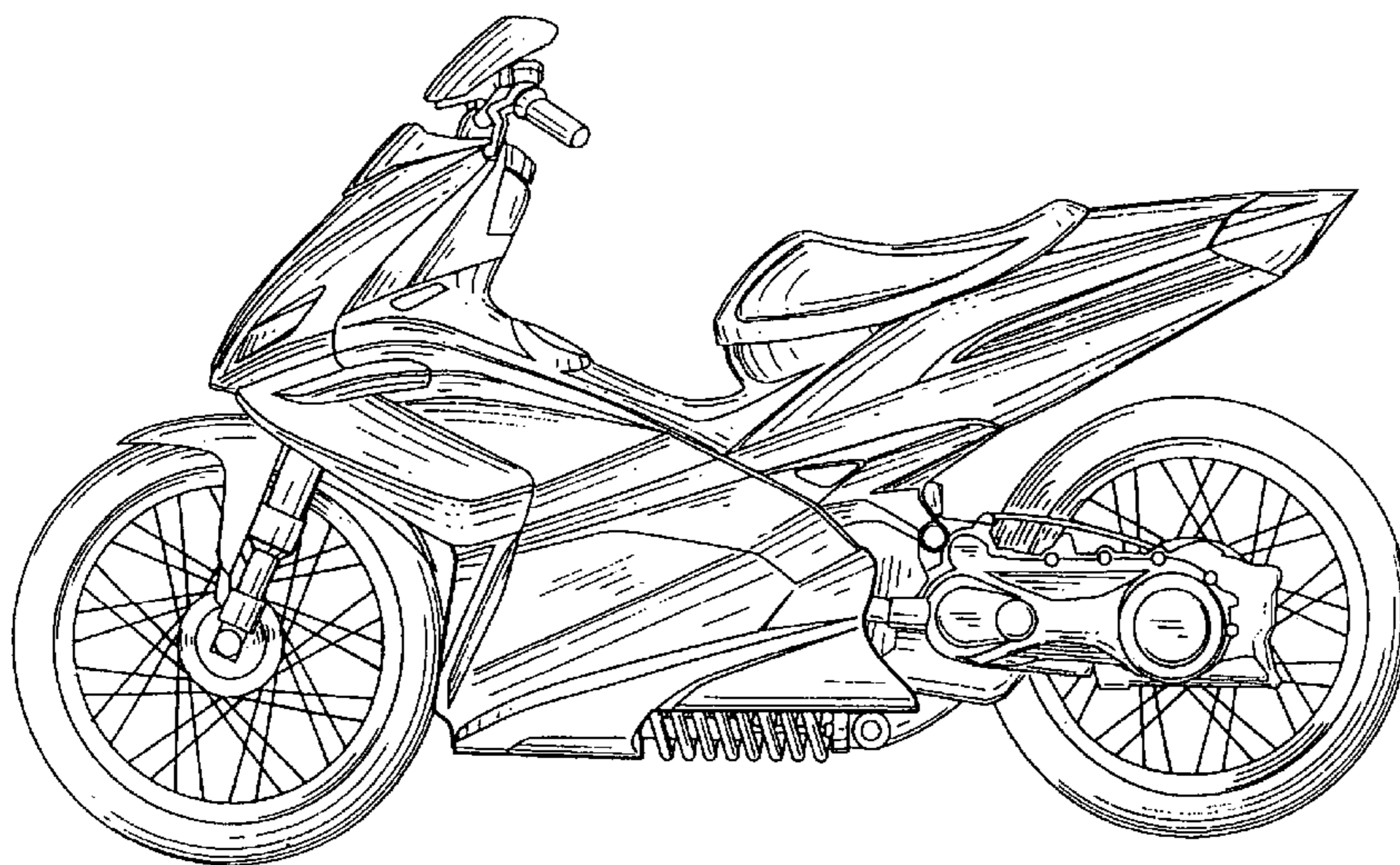

FIG. 1



FIG. 2

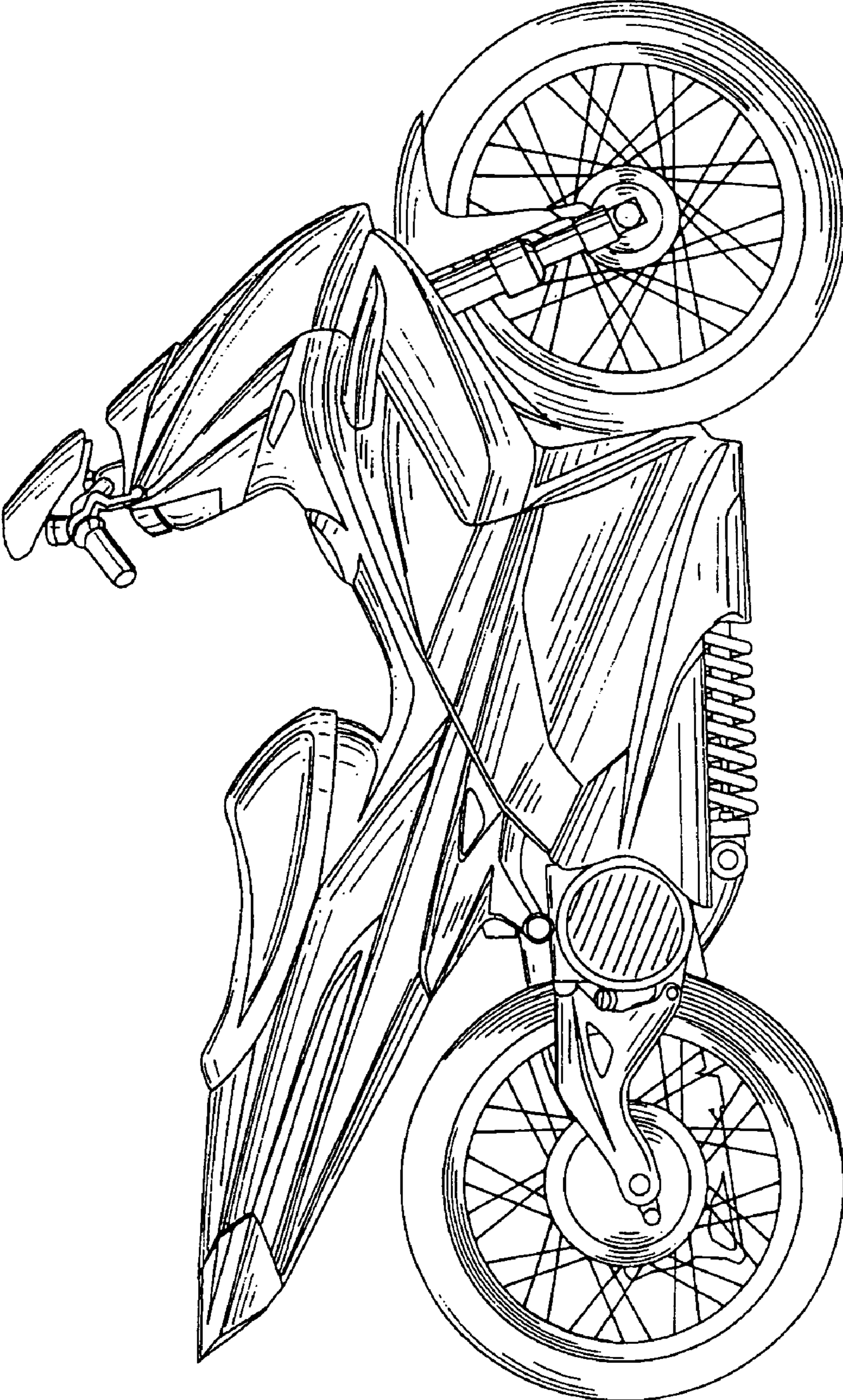

FIG. 3

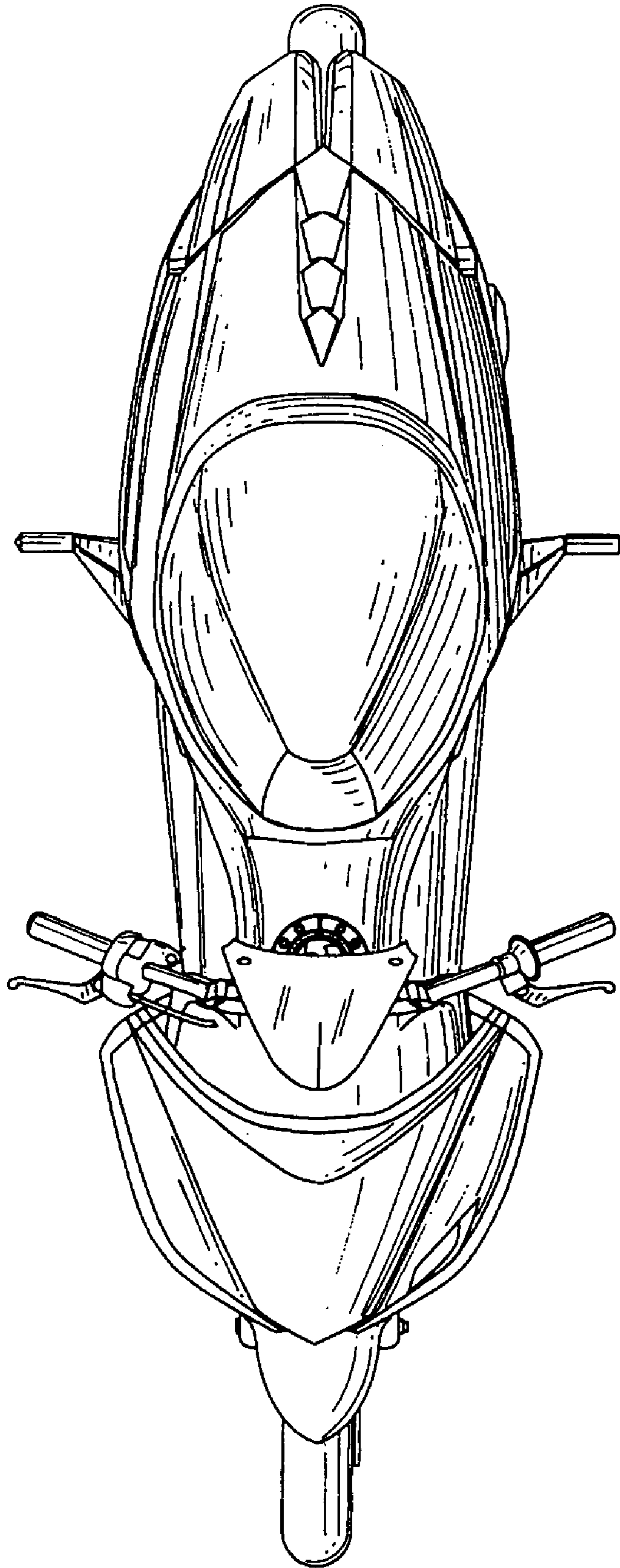

FIG. 4

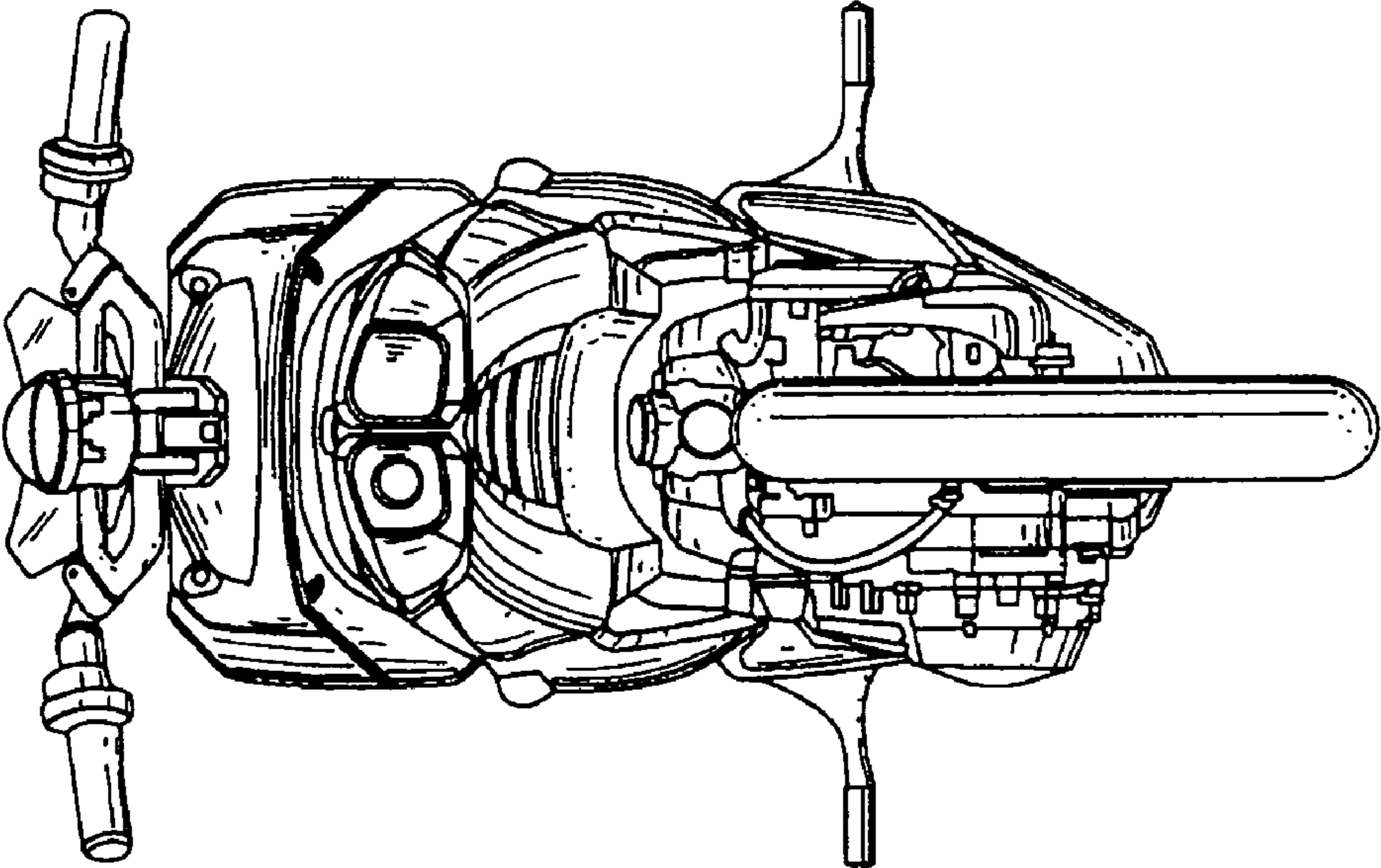

FIG. 5

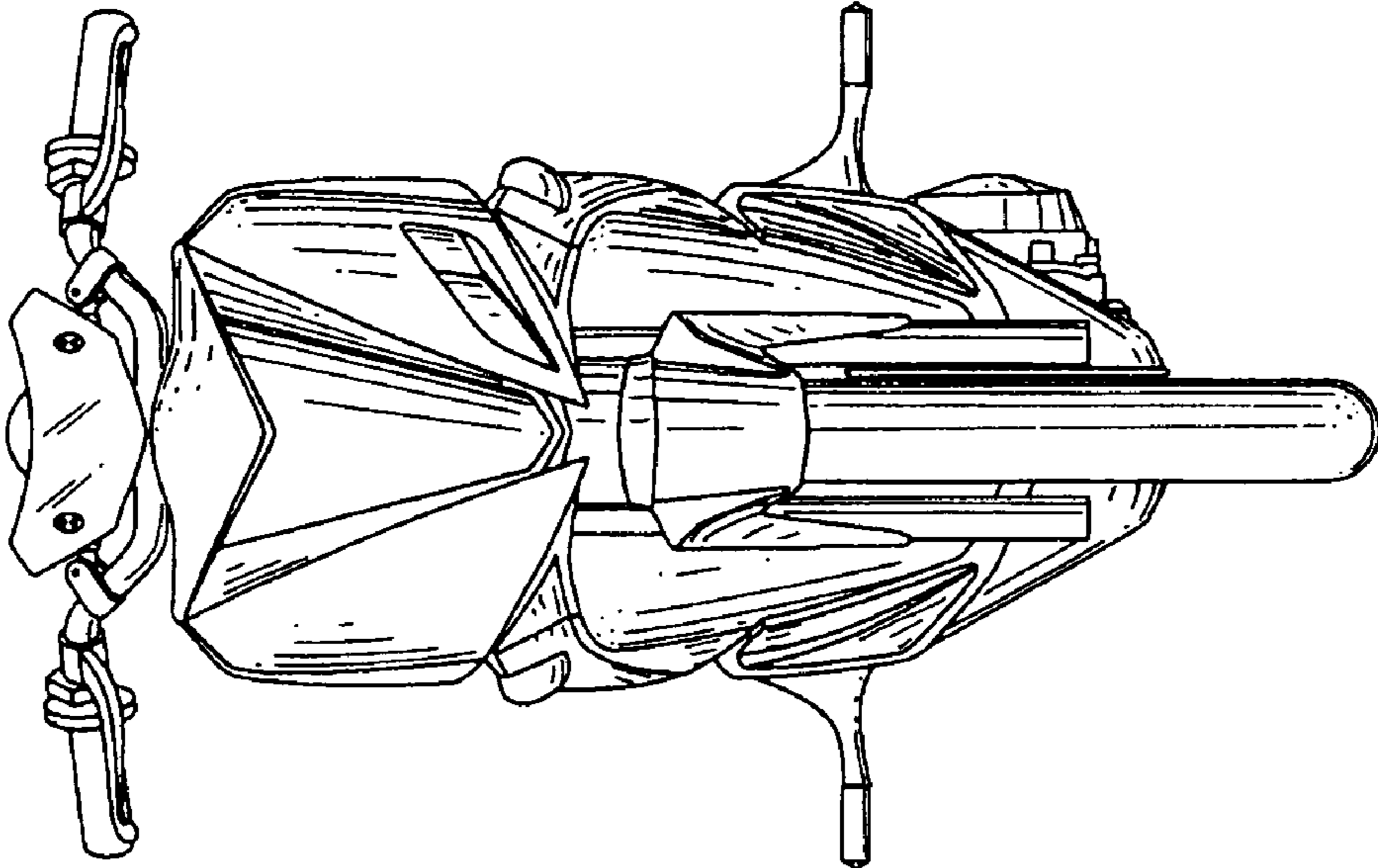

FIG. 6

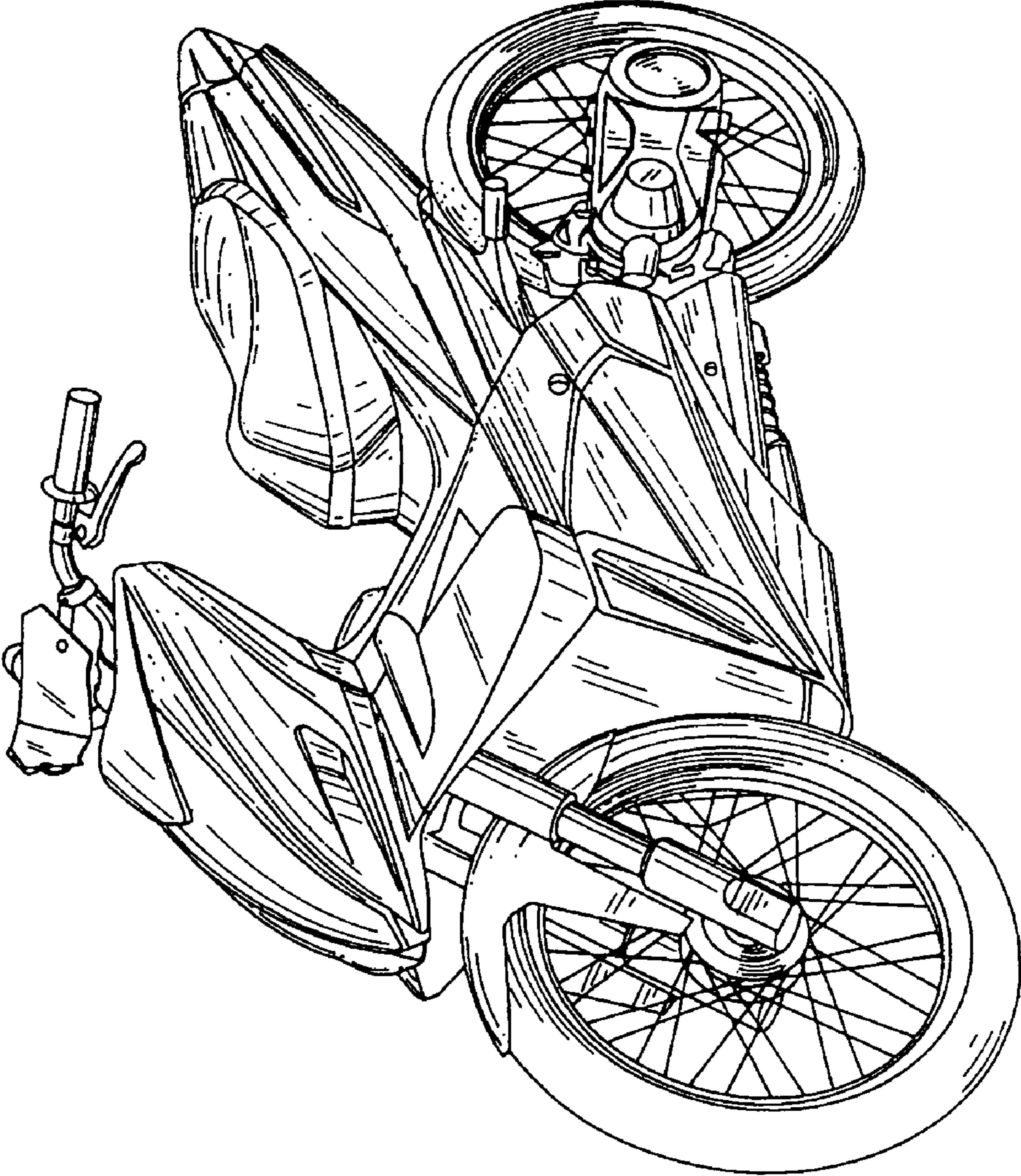

FIG. 7

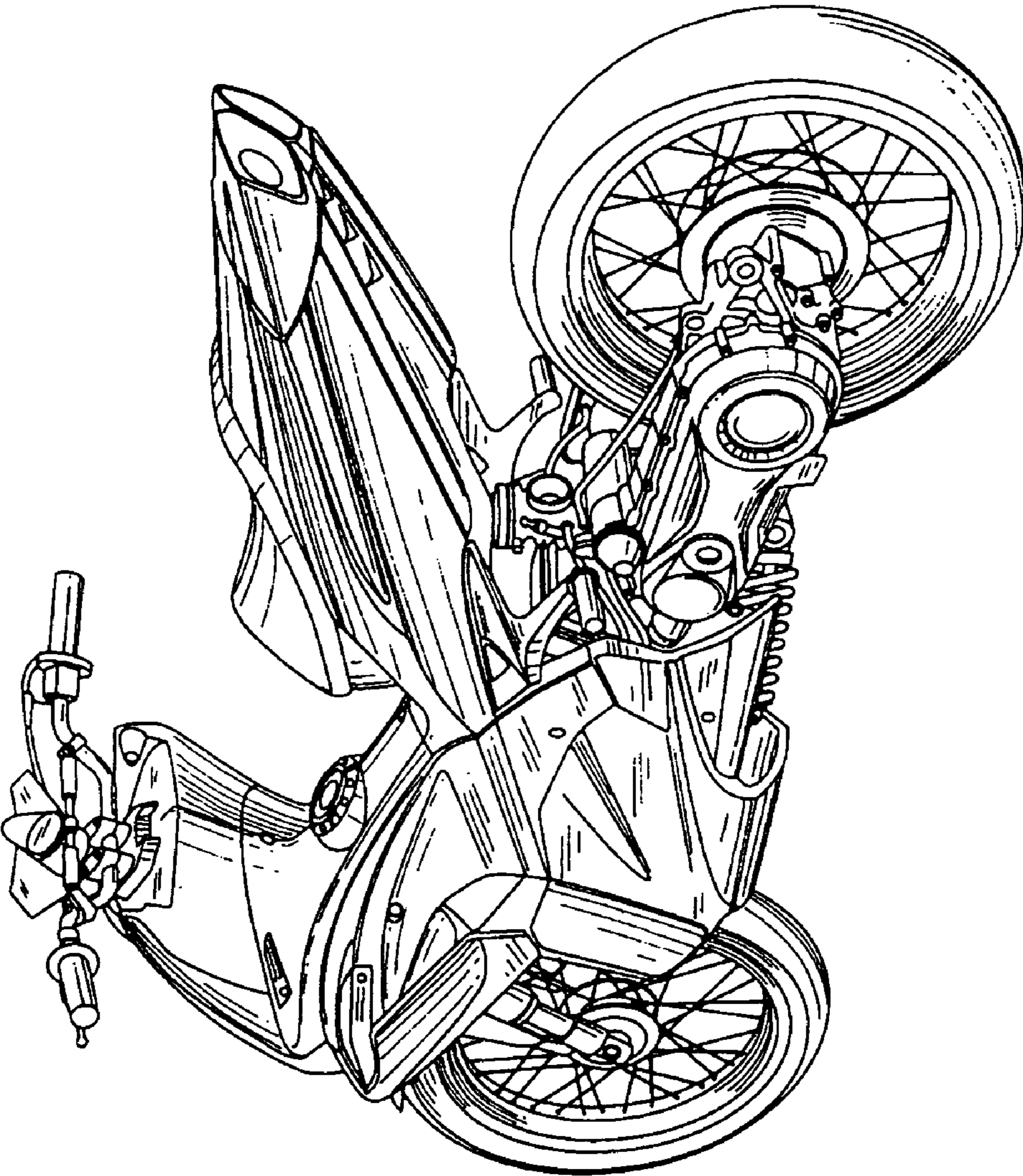

FIG. 8

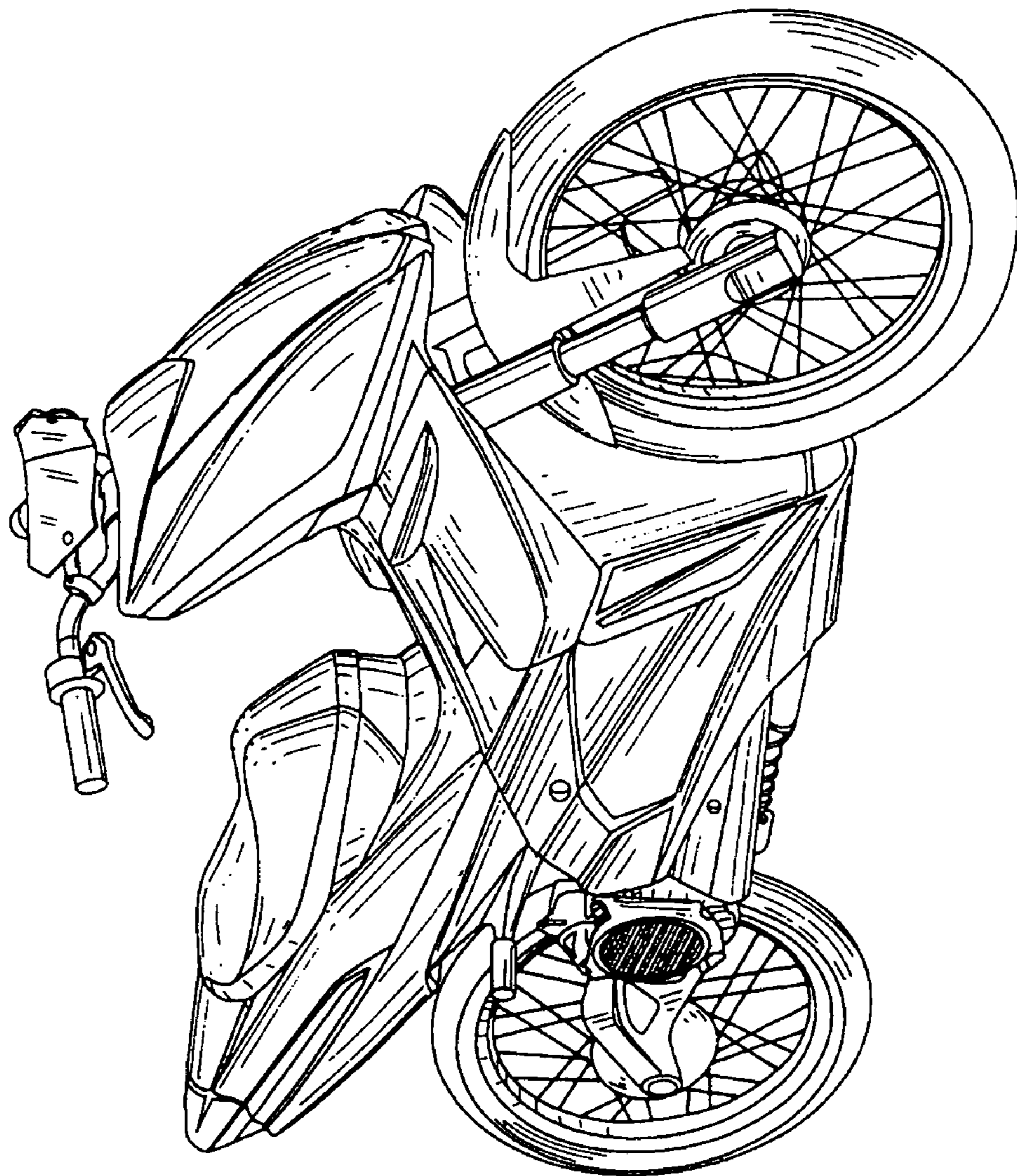

FIG. 9

