



US00D555481S

(12) **United States Design Patent**
Tseng

(10) **Patent No.:** **US D555,481 S**

(45) **Date of Patent:** **** Nov. 20, 2007**

(54) **MOTOR OIL BOTTLE**

(75) Inventor: **Tsz-Jiou Lai Tseng, Shu-Lin (TW)**

(73) Assignee: **Vic Hung Petroleum Chemical Co., Ltd., Taipei Hsien (TW)**

(**) Term: **14 Years**

(21) Appl. No.: **29/238,504**

(22) Filed: **Sep. 19, 2005**

(51) **LOC (8) Cl.** **09-01**

(52) **U.S. Cl.** **D9/523; D9/563; D9/570; D9/575**

(58) **Field of Classification Search** **D9/682-694, D9/516, 520, 523-528, 541-543, 563, 564, D9/570-575; 215/381-385, 396, 398, 400; D23/211.1**

See application file for complete search history.

(56) **References Cited**

U.S. PATENT DOCUMENTS

D103,520 S *	3/1937	Smith	D9/522
D190,056 S *	4/1961	Diamond	D9/526
D194,071 S *	11/1962	Anderson et al.	D9/523
D195,064 S *	4/1963	Dike	D9/523
D195,600 S *	7/1963	Neyman	D9/523
D199,644 S *	11/1964	Trombley	D9/543 X
D201,213 S *	5/1965	Petitto	D9/523
D213,304 S *	2/1969	Smith	D9/523
D220,247 S *	3/1971	Ghisolfi	D9/523
D237,256 S *	10/1975	Weckman	D9/523
D241,817 S *	10/1976	Campbell	D9/523

D265,887 S *	8/1982	Weckman	D9/523
D314,703 S *	2/1991	Segati	D9/523
D347,790 S *	6/1994	Lathrop et al.	D9/575 X
D354,916 S *	1/1995	Park	D9/523
5,918,753 A *	7/1999	Ogg et al.	215/382
D482,285 S *	11/2003	Desouza	D9/522
D508,407 S *	8/2005	Busch et al.	D9/522
D513,990 S *	1/2006	Archeny	D9/570 X

* cited by examiner

Primary Examiner—Carol Rademaker

(74) *Attorney, Agent, or Firm*—Mark A. Mersereau; Nikolai & Mersereau, P.A.

(57) **CLAIM**

The ornamental design for a motor oil bottle, as shown and described.

DESCRIPTION

FIG. 1 is a perspective view of a motor oil bottle;

FIG. 2 is a front view thereof; proceeding

FIG. 3 is a back view thereof;

FIG. 4 is a left side view thereof;

FIG. 5 is a right side view thereof;

FIG. 6 is a top view thereof; and,

FIG. 7 is a bottom view thereof.

The broken lines shown in the drawings are for environmental purposes only and form no part of the claimed design.

1 Claim, 7 Drawing Sheets

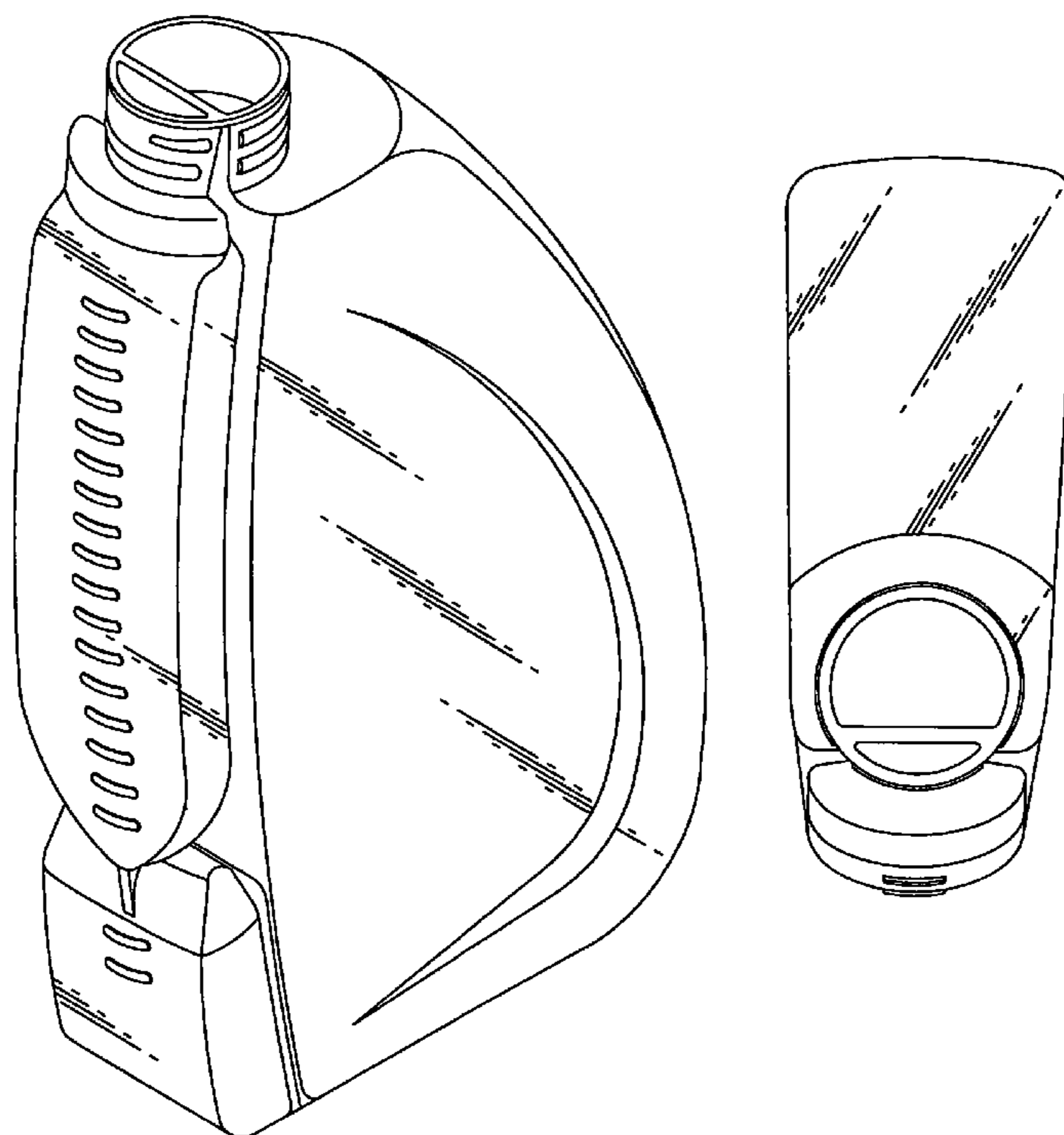

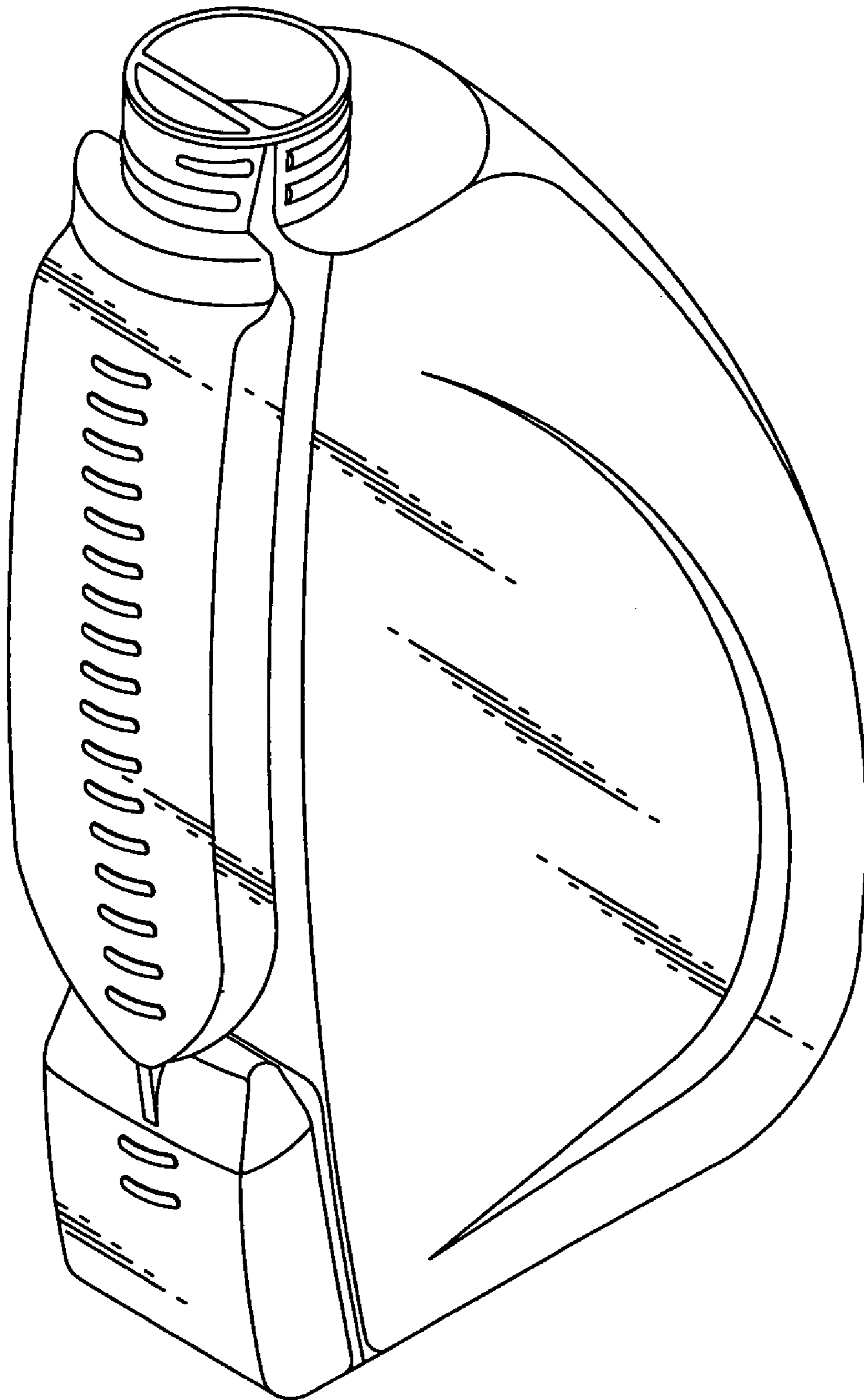

FIG. 1

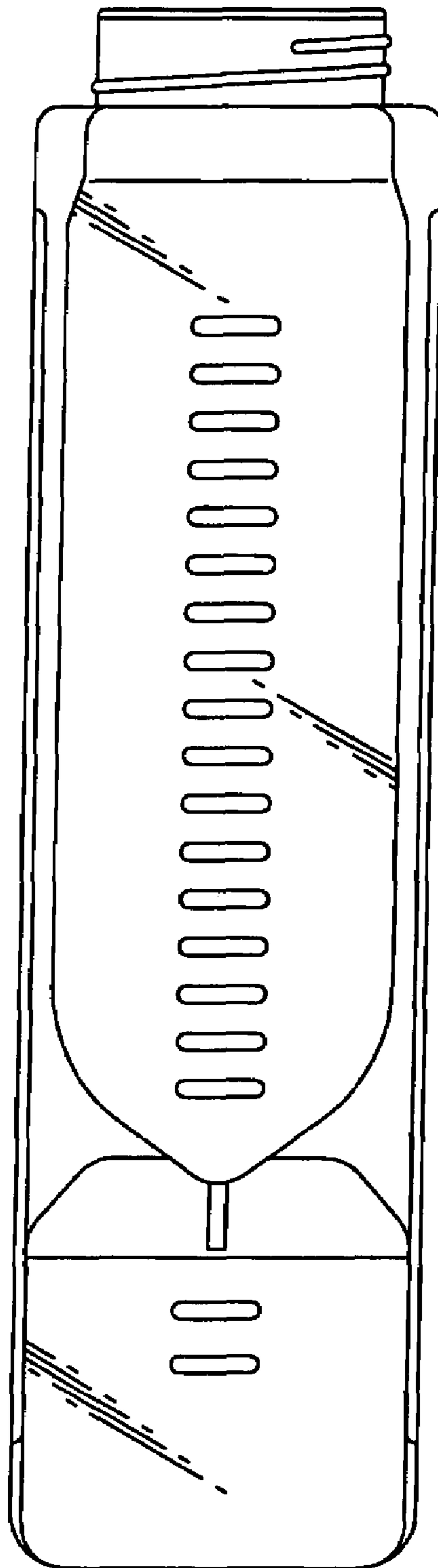

FIG.2

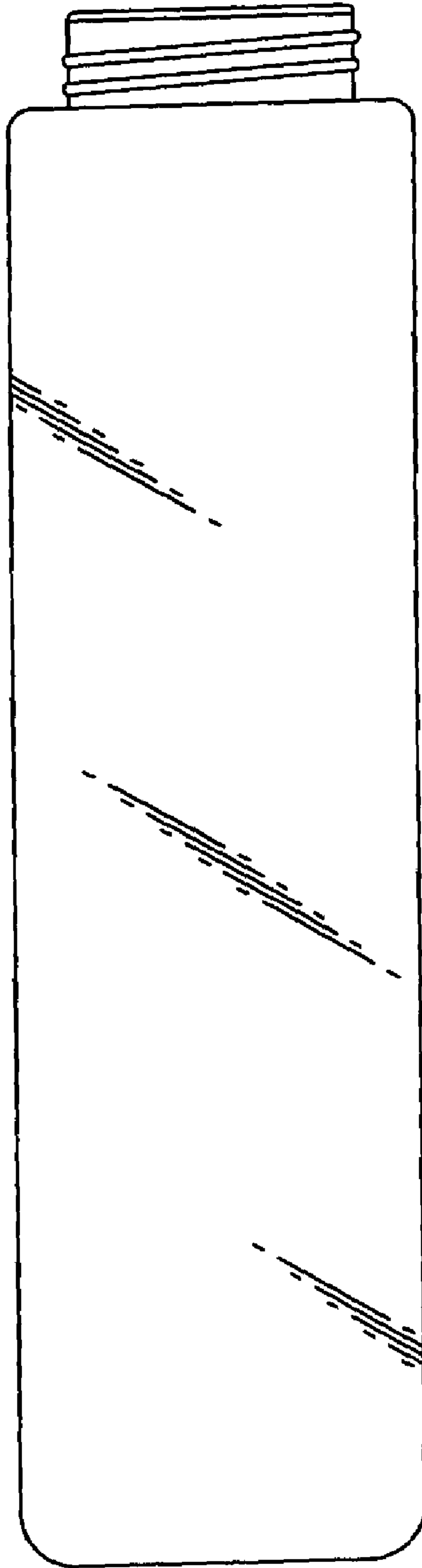

FIG. 3

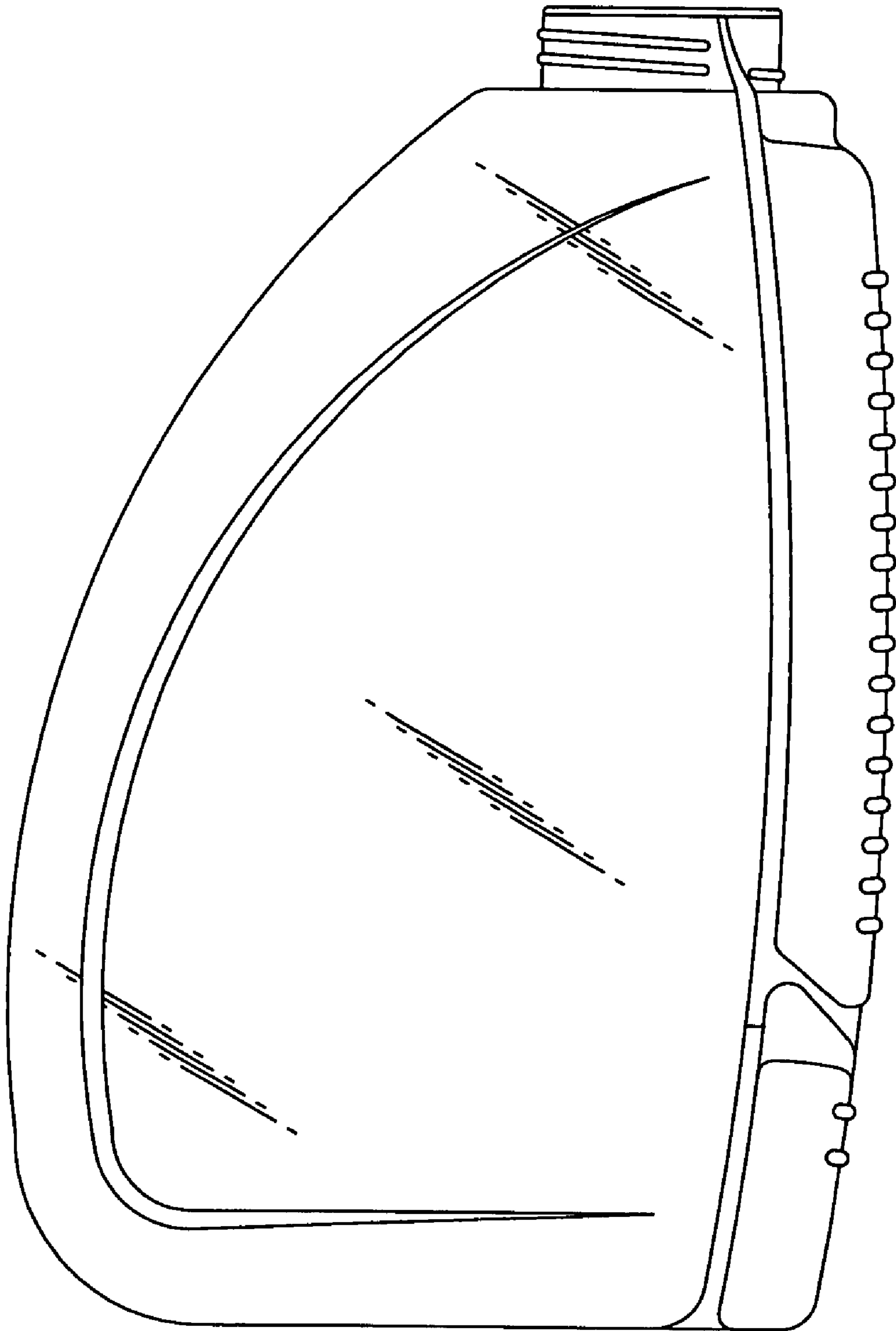

FIG.4

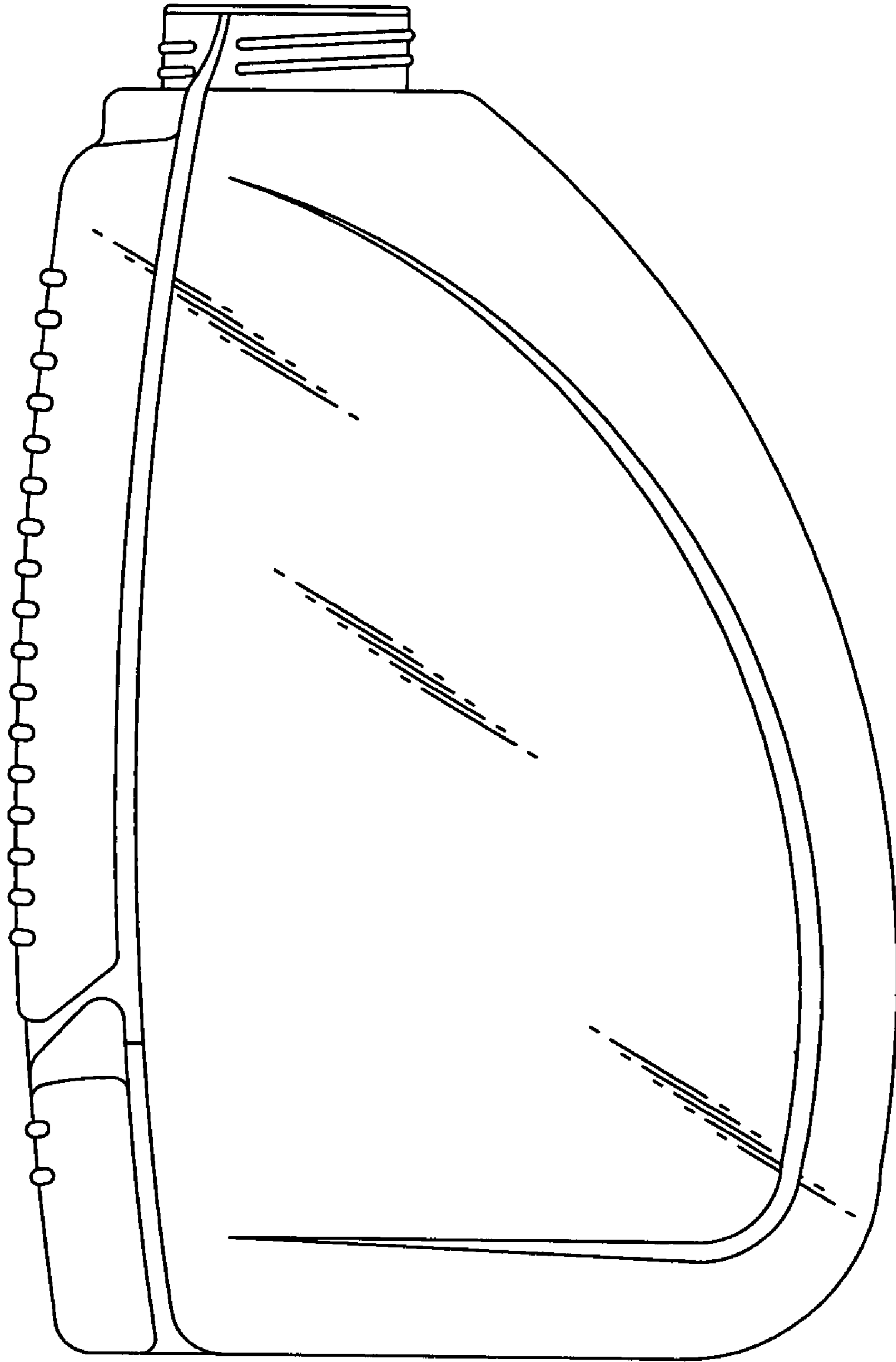

FIG. 5

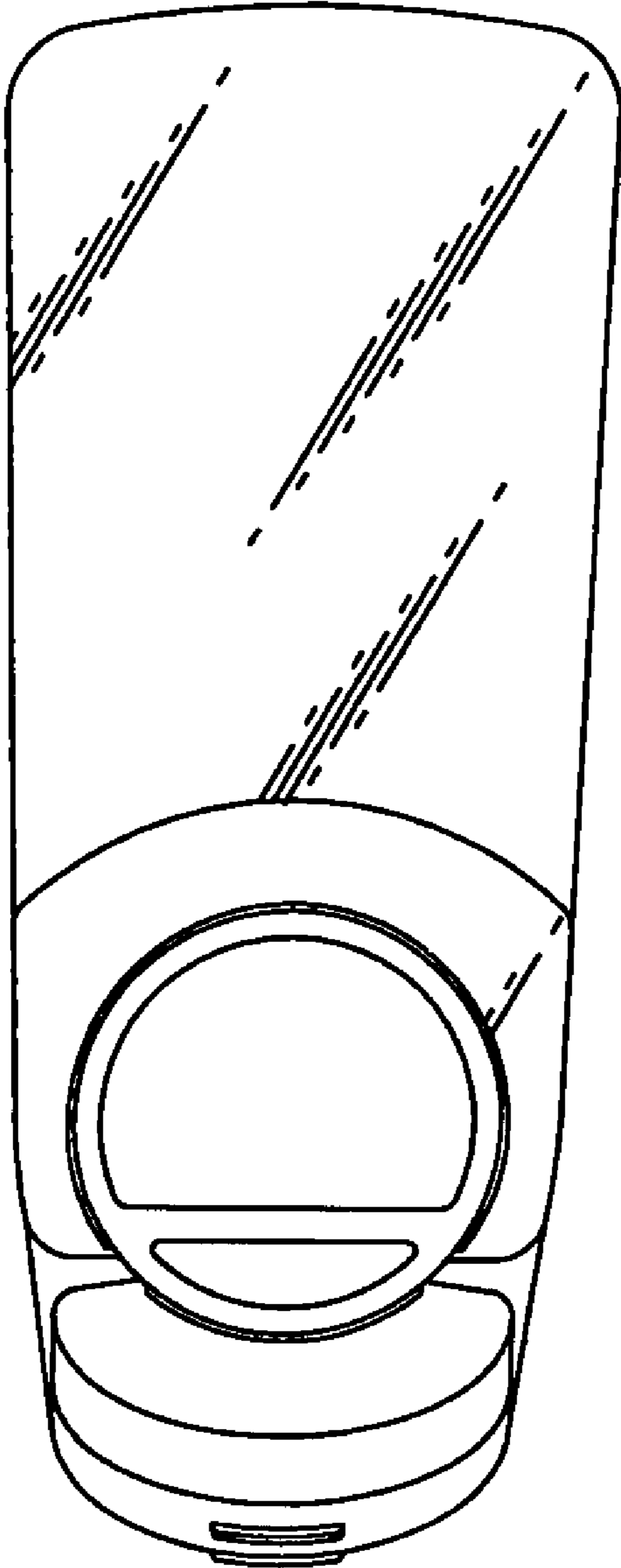

FIG.6

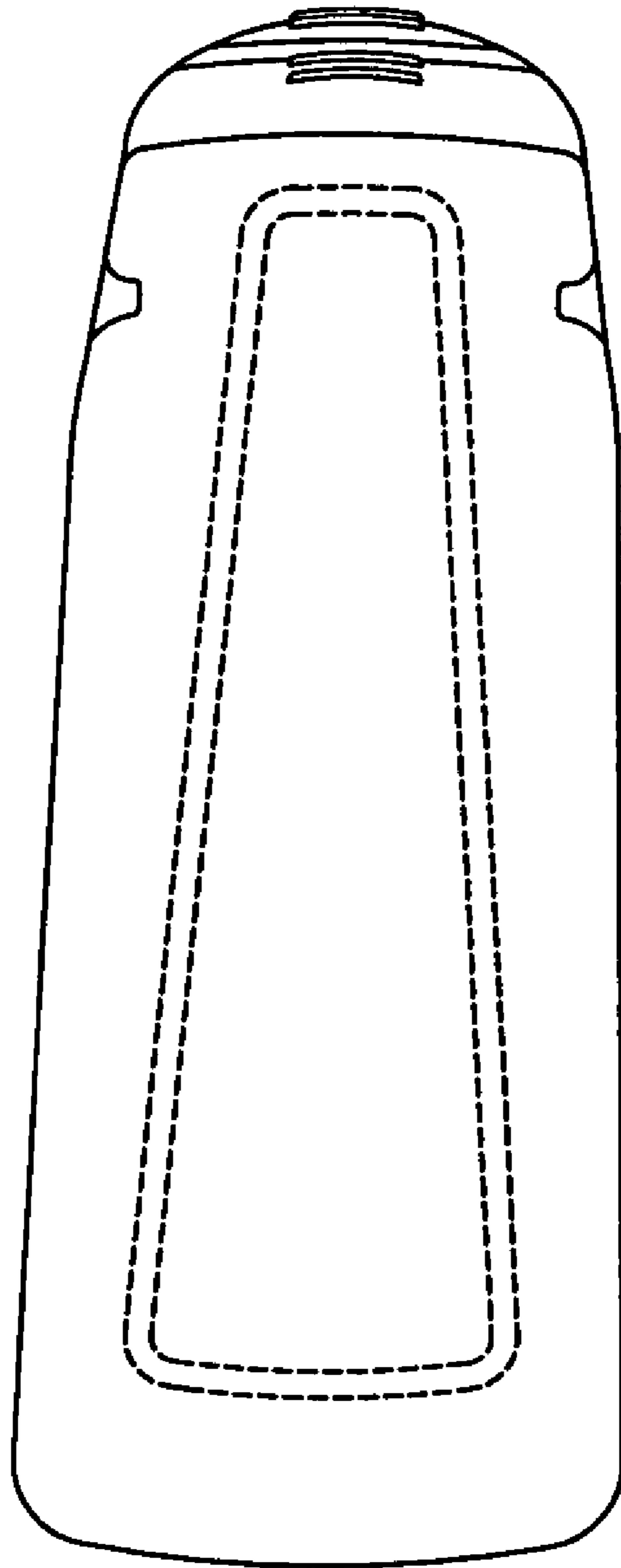

FIG. 7