



US00D555286S

(12) **United States Design Patent**
Long

(10) **Patent No.:** **US D555,286 S**

(45) **Date of Patent:** **** Nov. 13, 2007**

(54) **HAIR TRIMMER**

(75) Inventor: **Jason M. Long**, Fulton, IL (US)

(73) Assignee: **Wahl Clipper Corporation**, Sterling, IL (US)

(**) Term: **14 Years**

(21) Appl. No.: **29/263,874**

(22) Filed: **Jul. 31, 2006**

(51) **LOC (8) Cl.** **28-03**

(52) **U.S. Cl.** **D28/53**

(58) **Field of Classification Search** D30/201,
D30/34, 34.05, 34.1, 34.2, 41-41.6, 43-43.92,
D30/44-45, 526-533; D28/44, 44.1, 49-54
See application file for complete search history.

(56) **References Cited**

U.S. PATENT DOCUMENTS

| | | | |
|--------------|---------|--------------------|--------|
| D454,980 S | 3/2002 | Long et al. | |
| D455,862 S | 4/2002 | Wagenknecht et al. | |
| D458,710 S | 6/2002 | Altamore et al. | |
| D470,272 S * | 2/2003 | Fong | D28/53 |
| D477,439 S * | 7/2003 | Dirks | D28/53 |
| D479,364 S * | 9/2003 | Long | D28/54 |
| D495,830 S * | 9/2004 | Cornelissen | D28/49 |
| D499,211 S | 11/2004 | Altamore et al. | |
| D500,891 S | 1/2005 | Altamore et al. | |
| D512,796 S | 12/2005 | Dirks et al. | |
| D513,344 S | 12/2005 | Choi | |
| D538,476 S * | 3/2007 | Laube | D28/54 |

* cited by examiner

Primary Examiner—Jennifer Rivard

(74) *Attorney, Agent, or Firm*—Greer, Burns & Crain, Ltd.

(57) **CLAIM**

The ornamental design for a hair trimmer, as shown and described.

DESCRIPTION

FIG. 1 is a front view of the present hair trimmer;

FIG. 2 is a right side view of the same;

FIG. 3 is a left side view of the same;

FIG. 4 is a rear view of the same;

FIG. 5 is a top view of the same;

FIG. 6 is a bottom view of the same;

FIG. 7 is a top perspective view of the same;

FIG. 8 is a front view of an alternate embodiment of the present hair trimmer;

FIG. 9 is a right side view of the same;

FIG. 10 is a left side view of the same;

FIG. 11 is a rear view of the same;

FIG. 12 is a top view of the same;

FIG. 13 is a bottom view of the same; and,

FIG. 14 is a top perspective view of the same.

The broken lines are shown for illustrative purposes only and form no part of the claimed design.

1 Claim, 12 Drawing Sheets

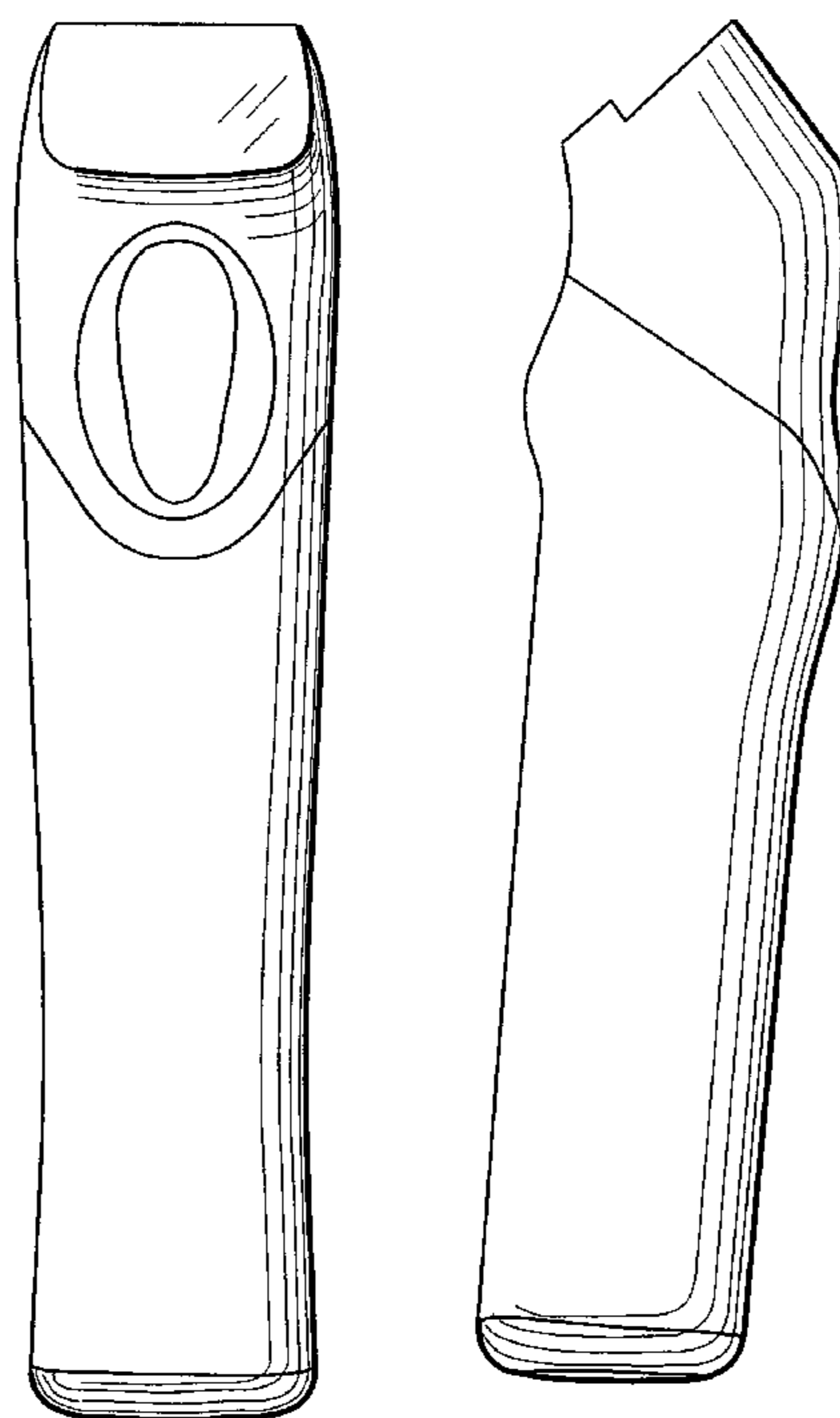

FIG. 1

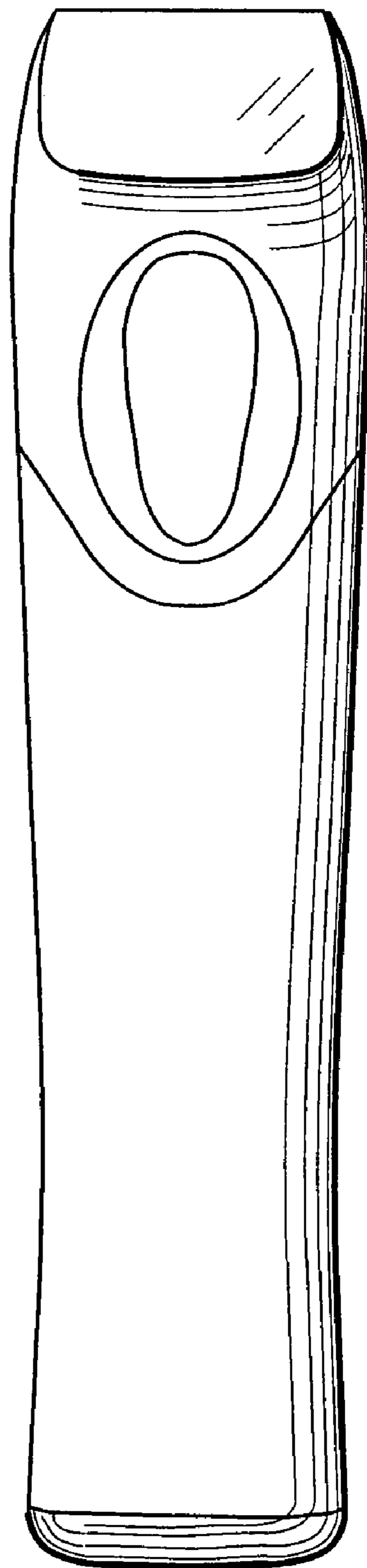

FIG. 2

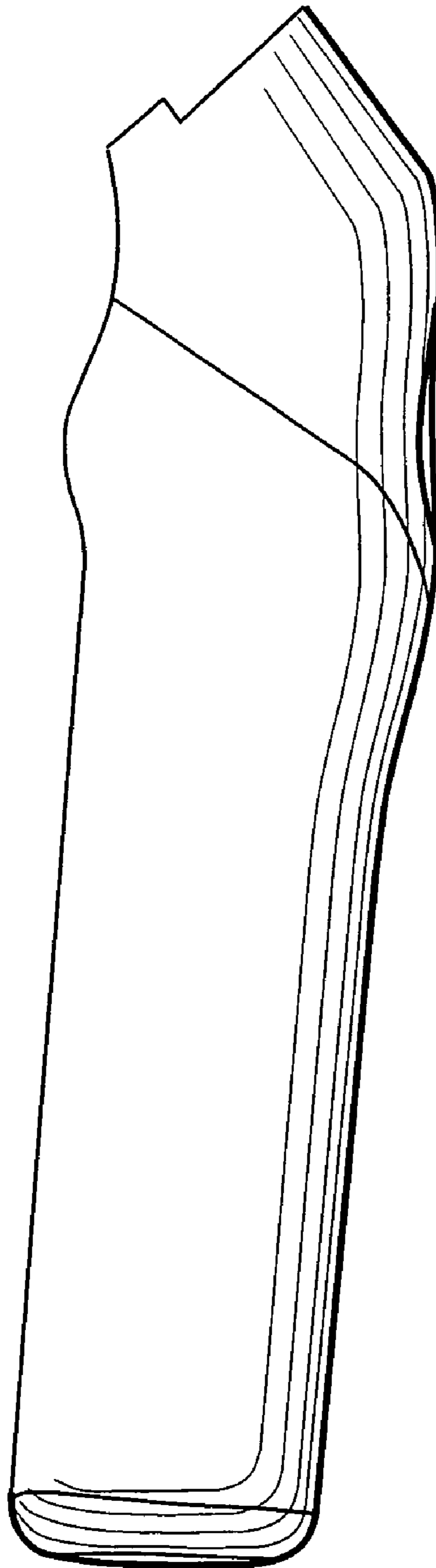

FIG. 3

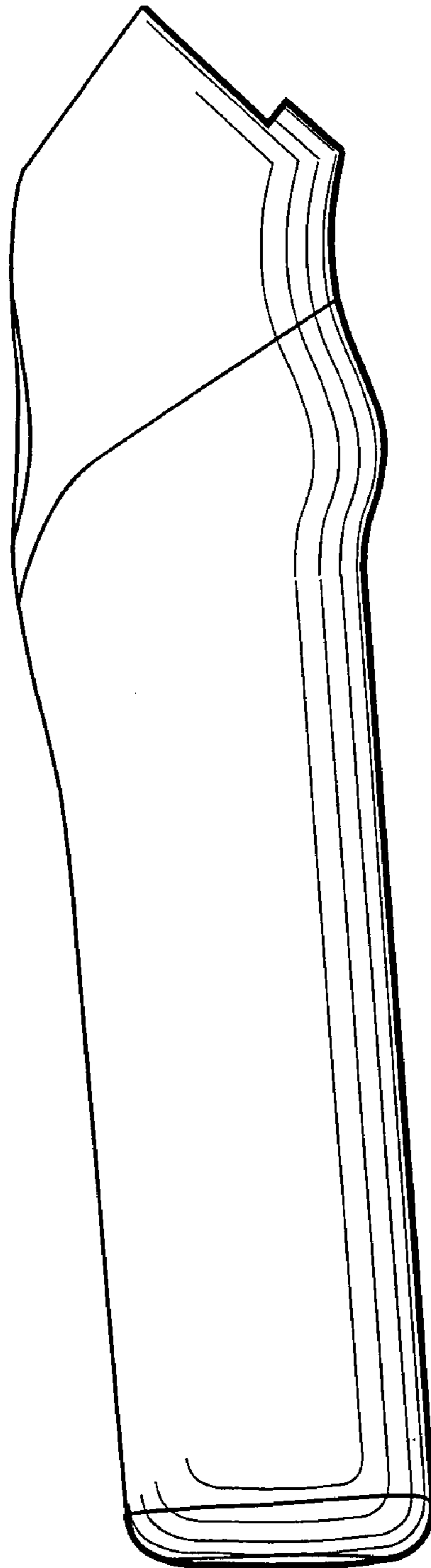

FIG. 4

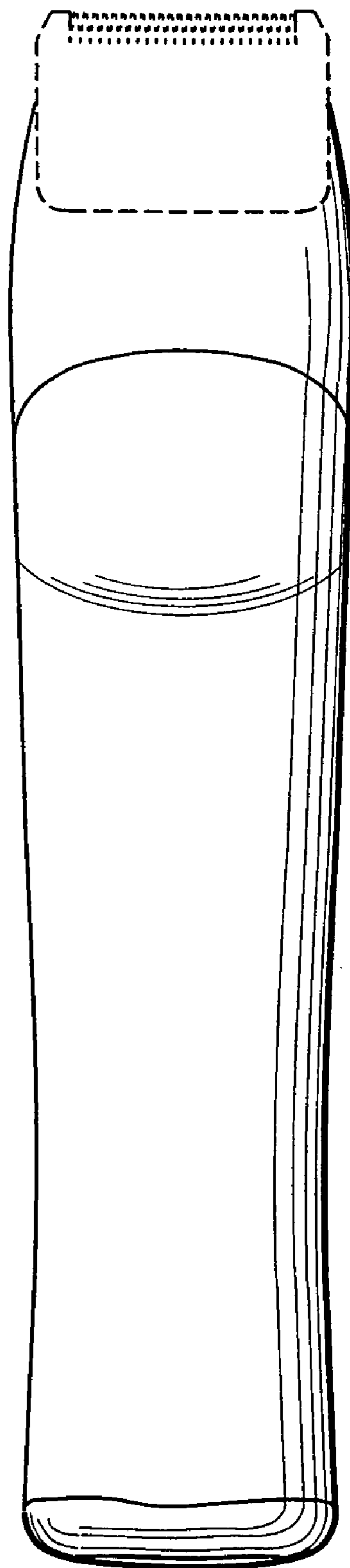

FIG. 5

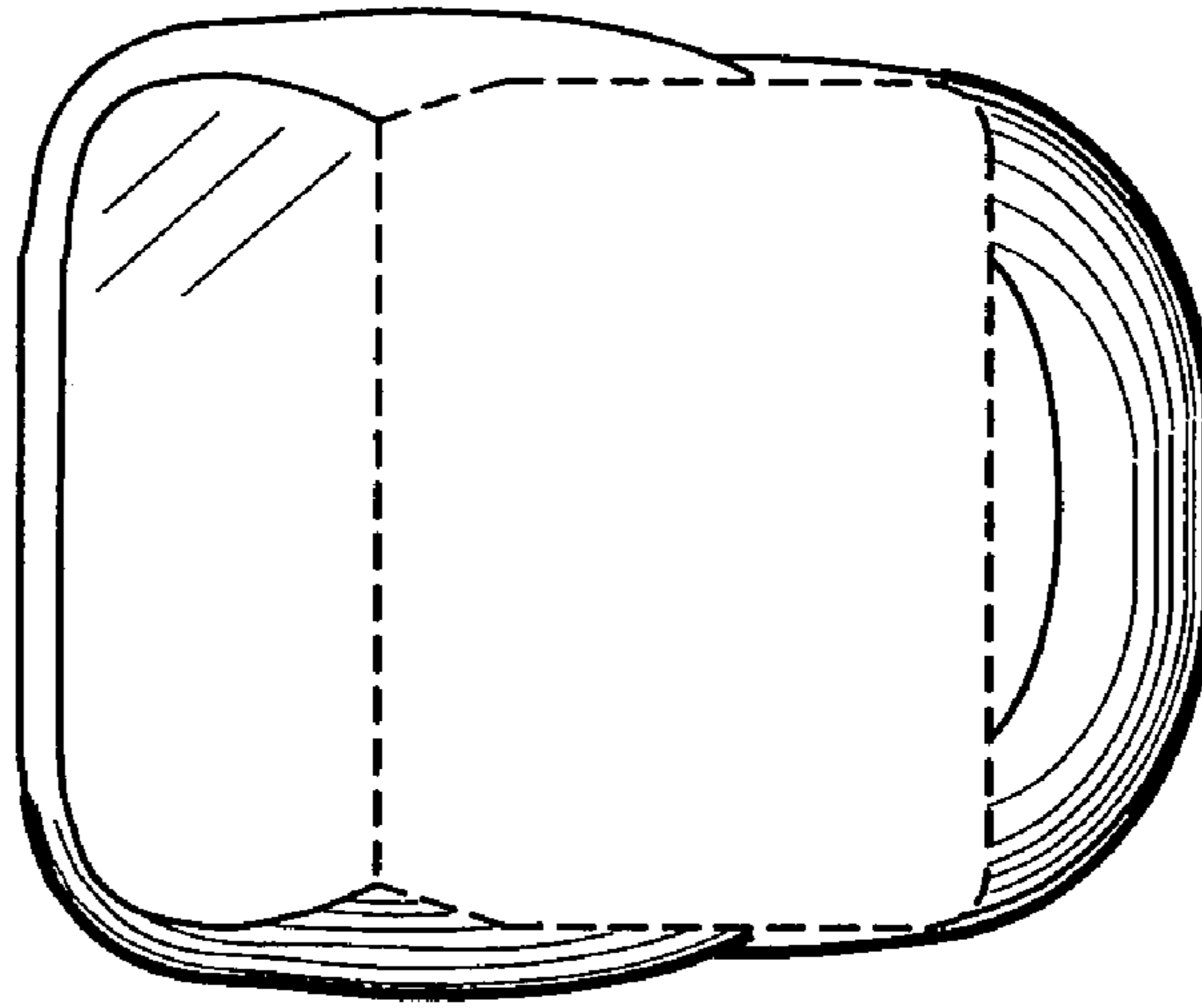

FIG. 6

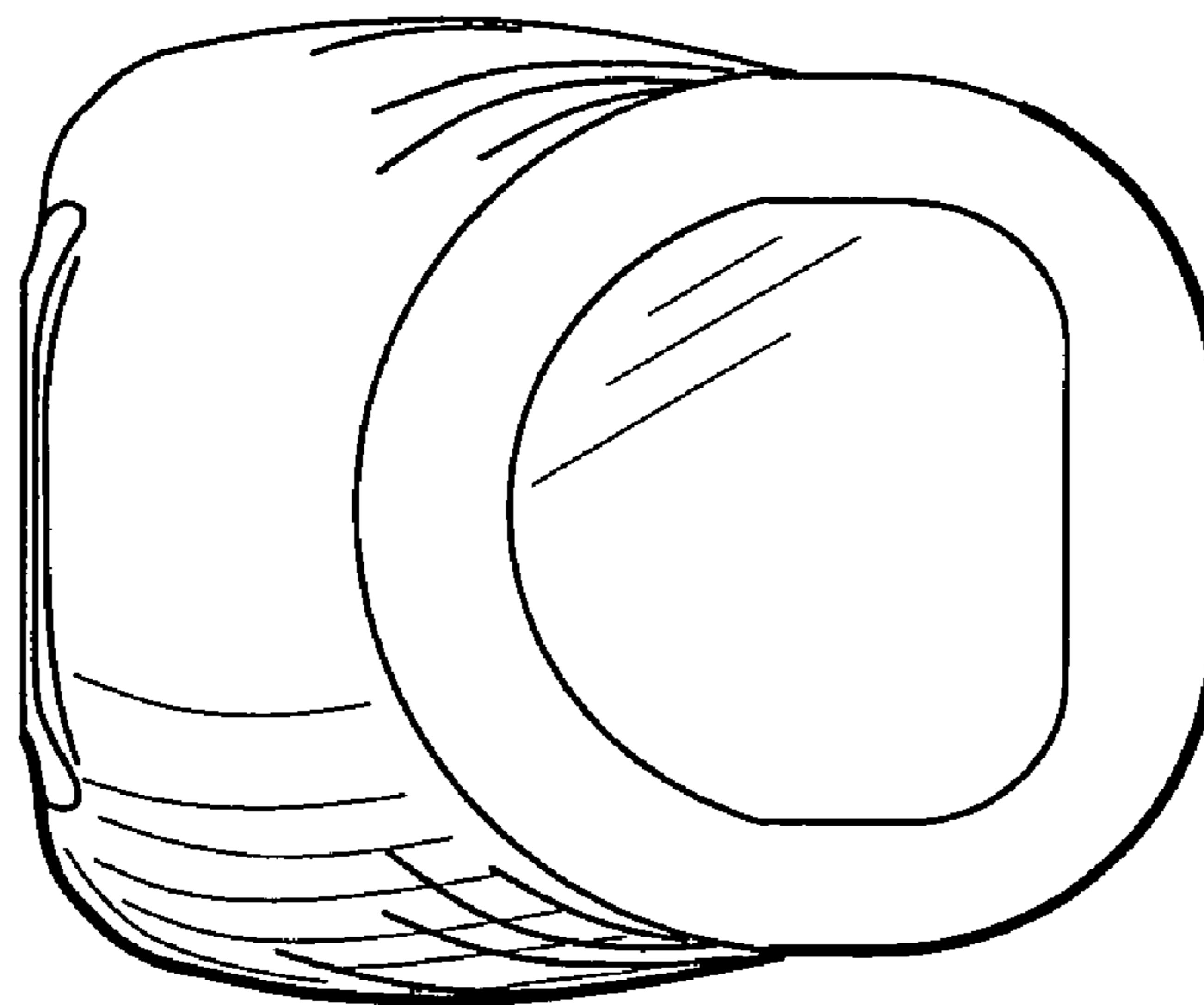

FIG. 7

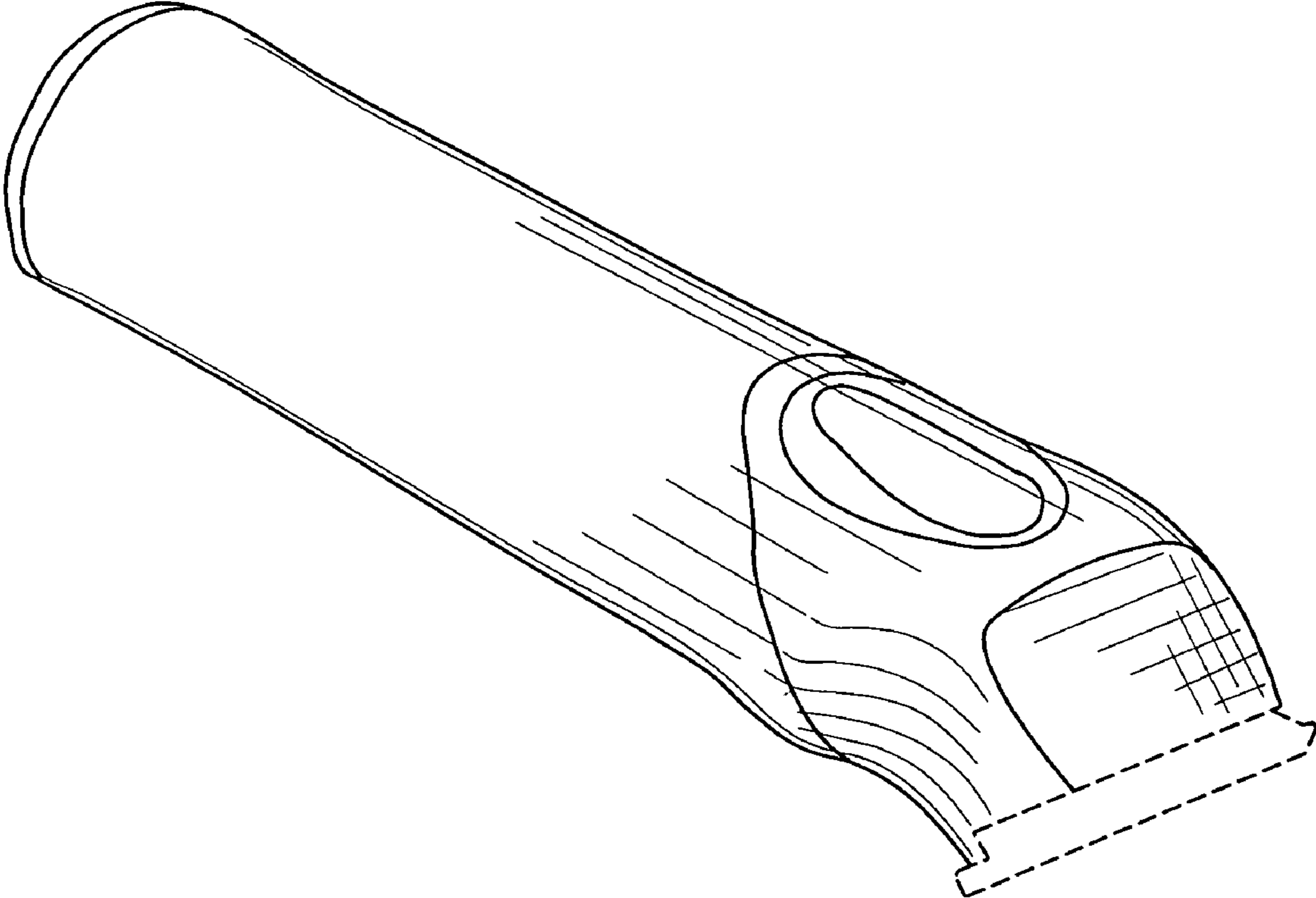

FIG. 8

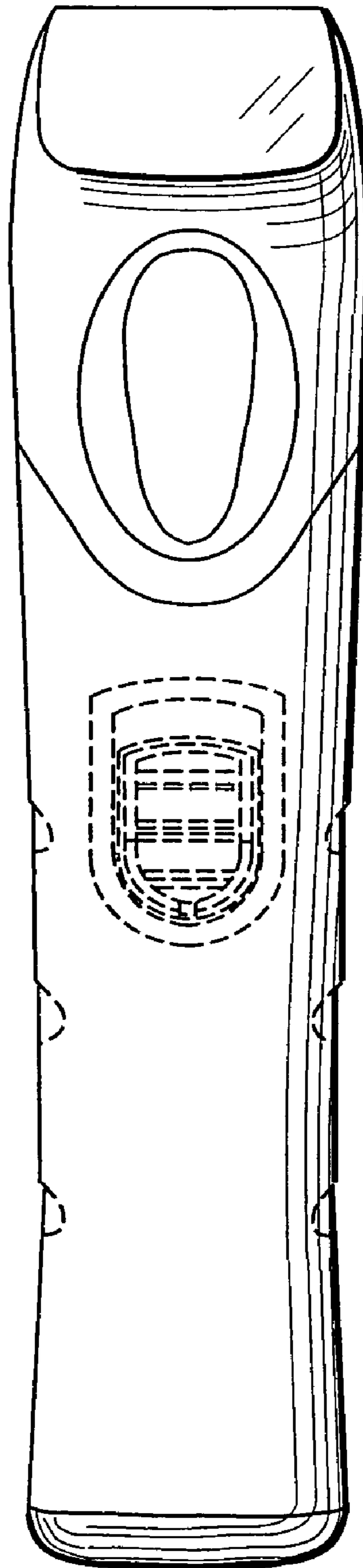

FIG. 9

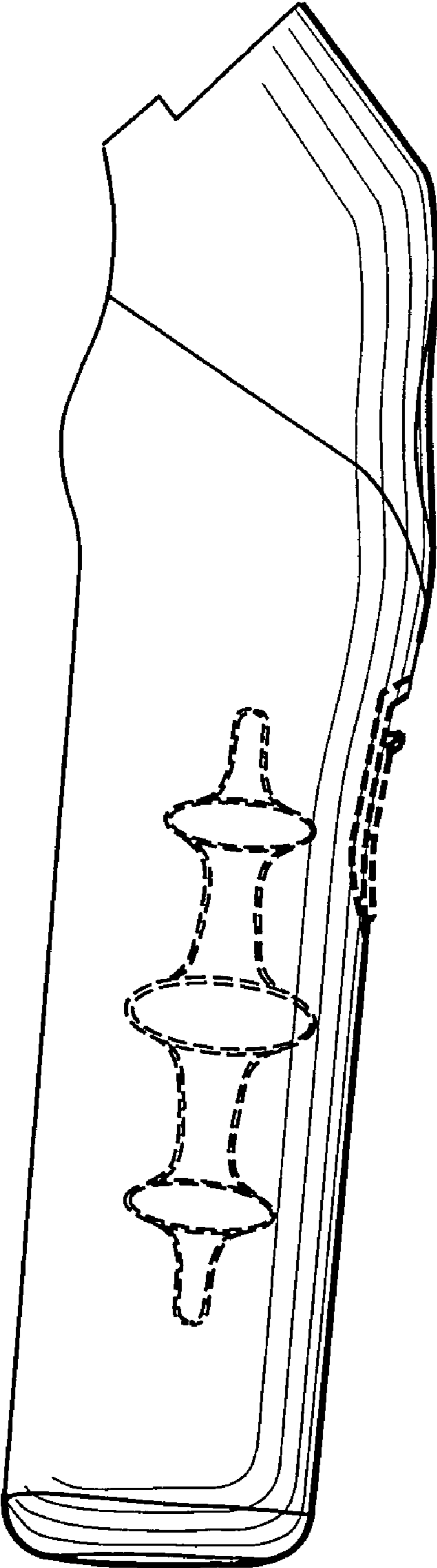

FIG. 10

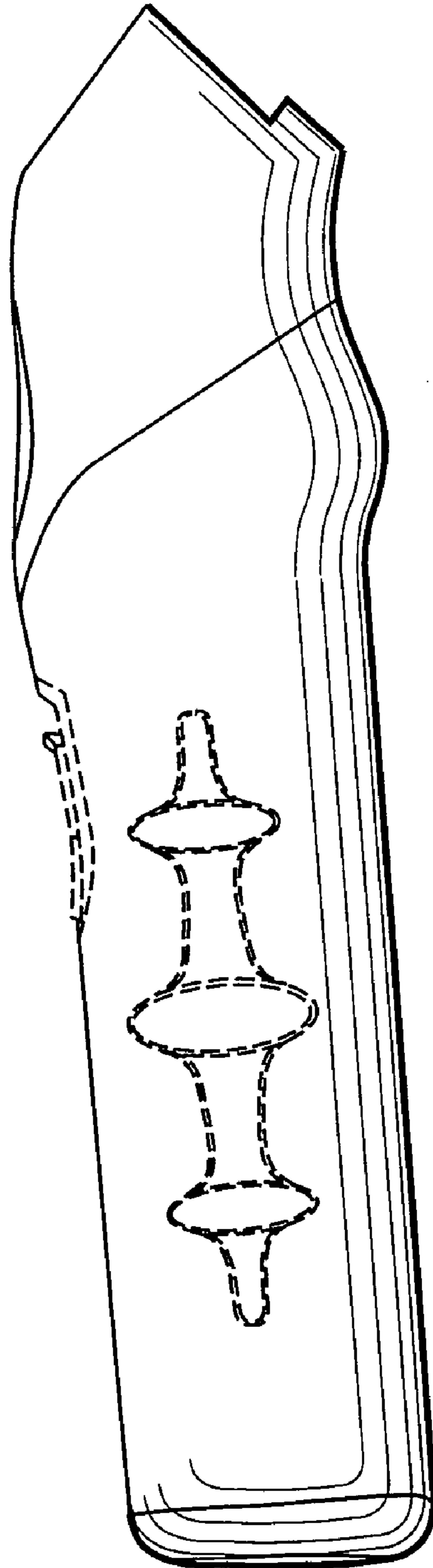

FIG. 11

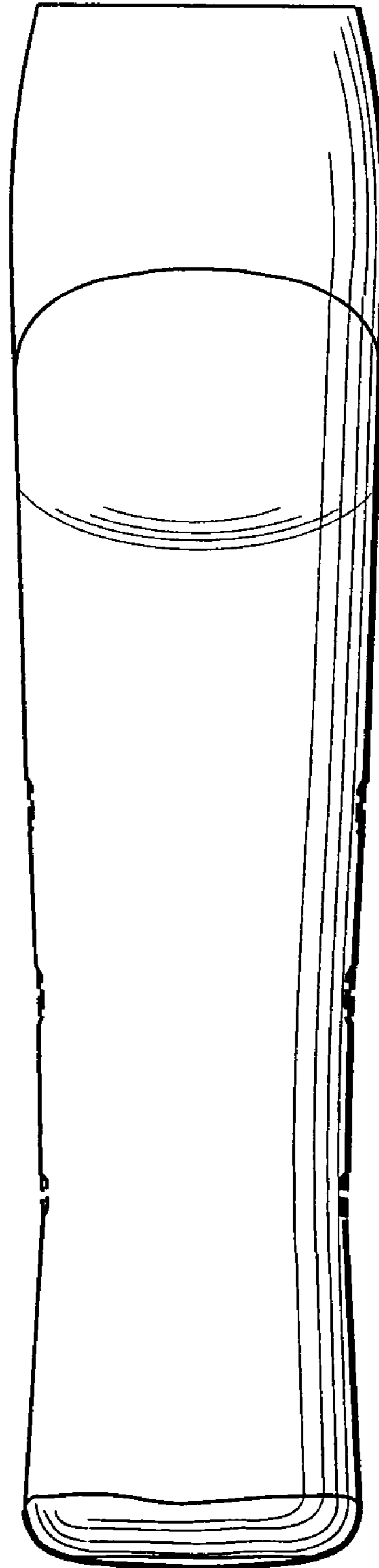

FIG. 12

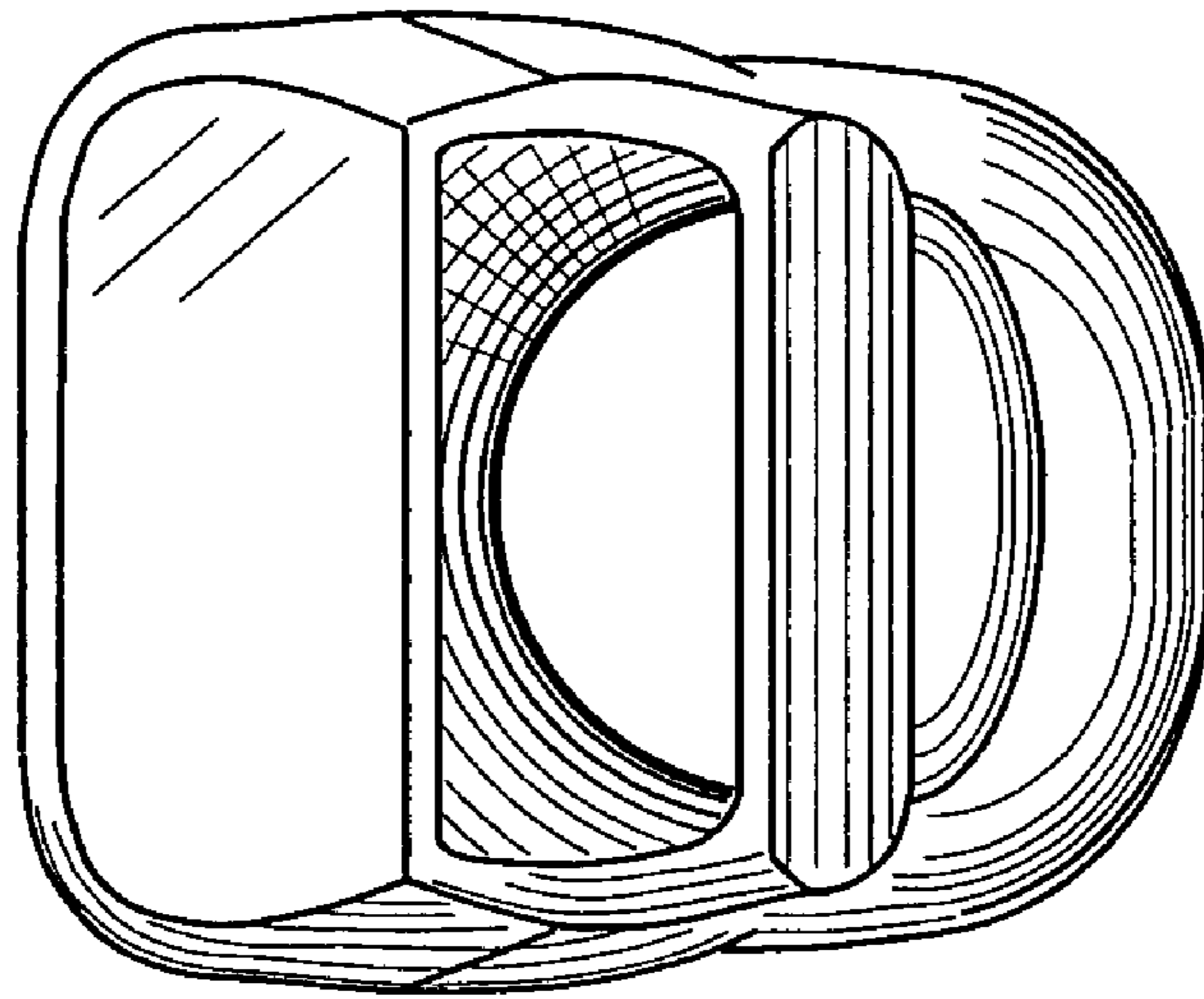

FIG. 13

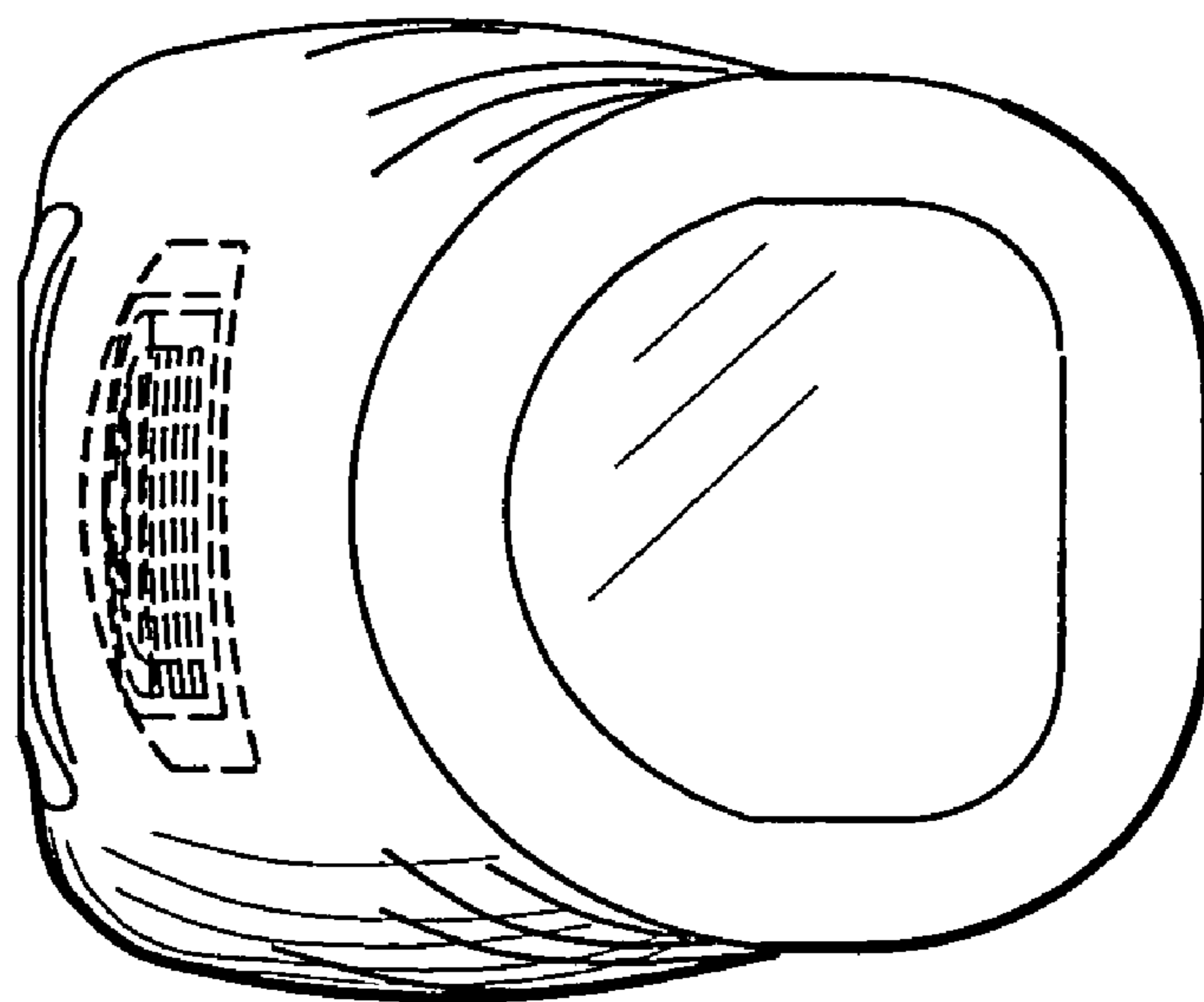

FIG. 14

