



US00D555256S

(12) **United States Design Patent**
Mattal et al.

(10) **Patent No.:** **US D555,256 S**

(45) **Date of Patent:** **** Nov. 13, 2007**

(54) **HURRICANE WINDOW AND SAFETY COVERING**

6,497,077 B1 12/2002 Emek
2002/0162286 A1* 11/2002 Heissenberg 52/202

(76) Inventors: **Kevin Mattal**, 1607 S. Main,
Blackwell, OK (US) 74631; **Joel Dyer**,
1607 S. Main, Blackwell, OK (US)
74631

* cited by examiner

Primary Examiner—Doris Clark
(74) *Attorney, Agent, or Firm*—Head, Johnson & Kachigian

(**) Term: **14 Years**

(57) **CLAIM**

(21) Appl. No.: **29/246,728**

The ornamental design for a hurricane window and safety covering, as shown and described.

(22) Filed: **May 5, 2006**

DESCRIPTION

(51) **LOC (8) Cl.** **25-02**

FIG. 1 is a perspective view of a hurricane window and safety covering in assembled position;

(52) **U.S. Cl.** **D25/52**

FIG. 2 is a front view thereof in exploded position;

(58) **Field of Classification Search** D25/52;
52/202, 203

FIG. 3 is a left side view thereof;

See application file for complete search history.

FIG. 4 is a right side view thereof;

(56) **References Cited**

FIG. 5 is a rear view thereof in assembled position;

U.S. PATENT DOCUMENTS

FIG. 6 is a top view thereof; and,

D247,047 S * 1/1978 Damiana D25/52
D270,477 S * 9/1983 Taylor D25/109
4,510,986 A * 4/1985 Schwankl 160/354

FIG. 7 is a bottom view thereof.

1 Claim, 3 Drawing Sheets

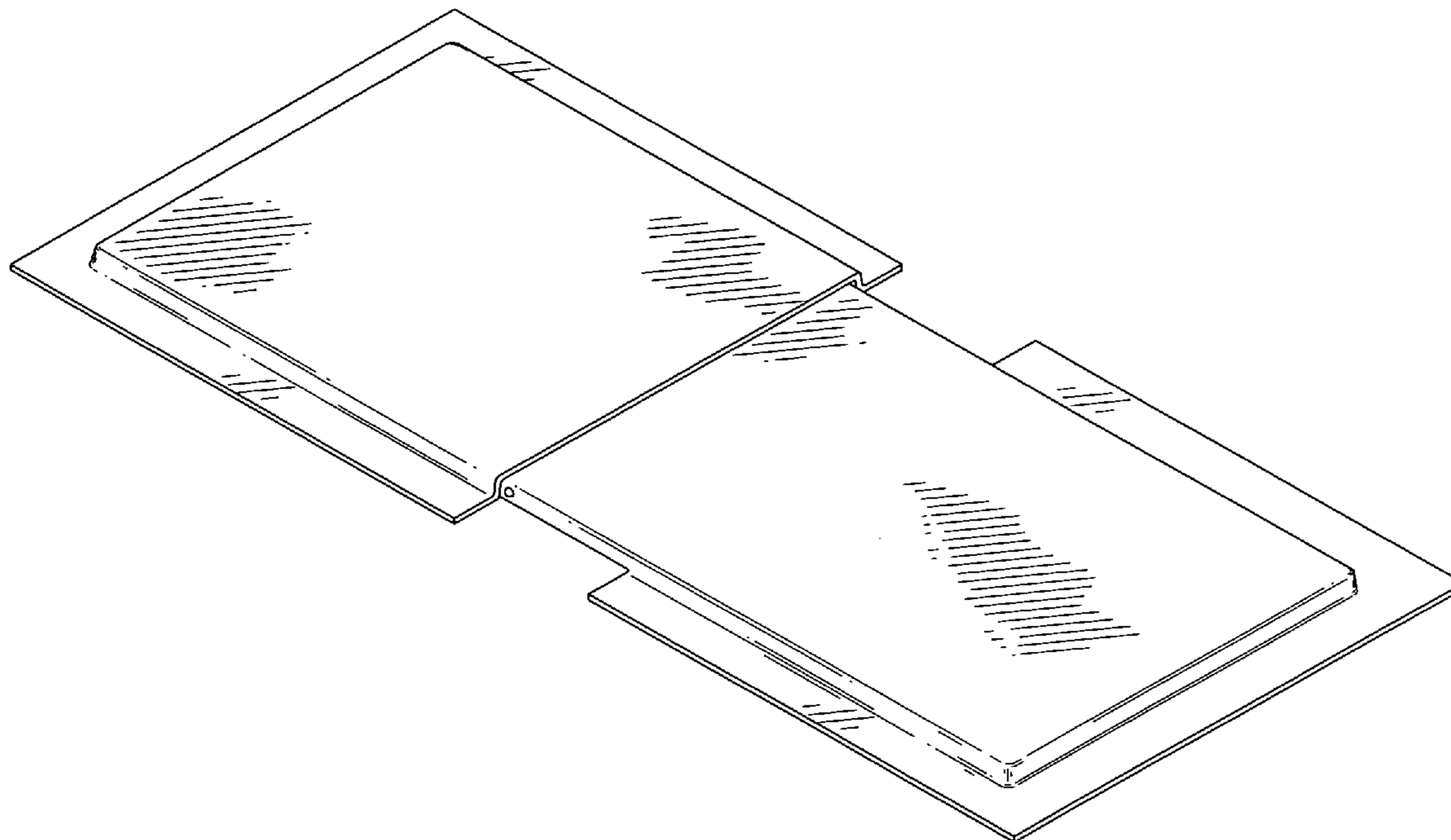

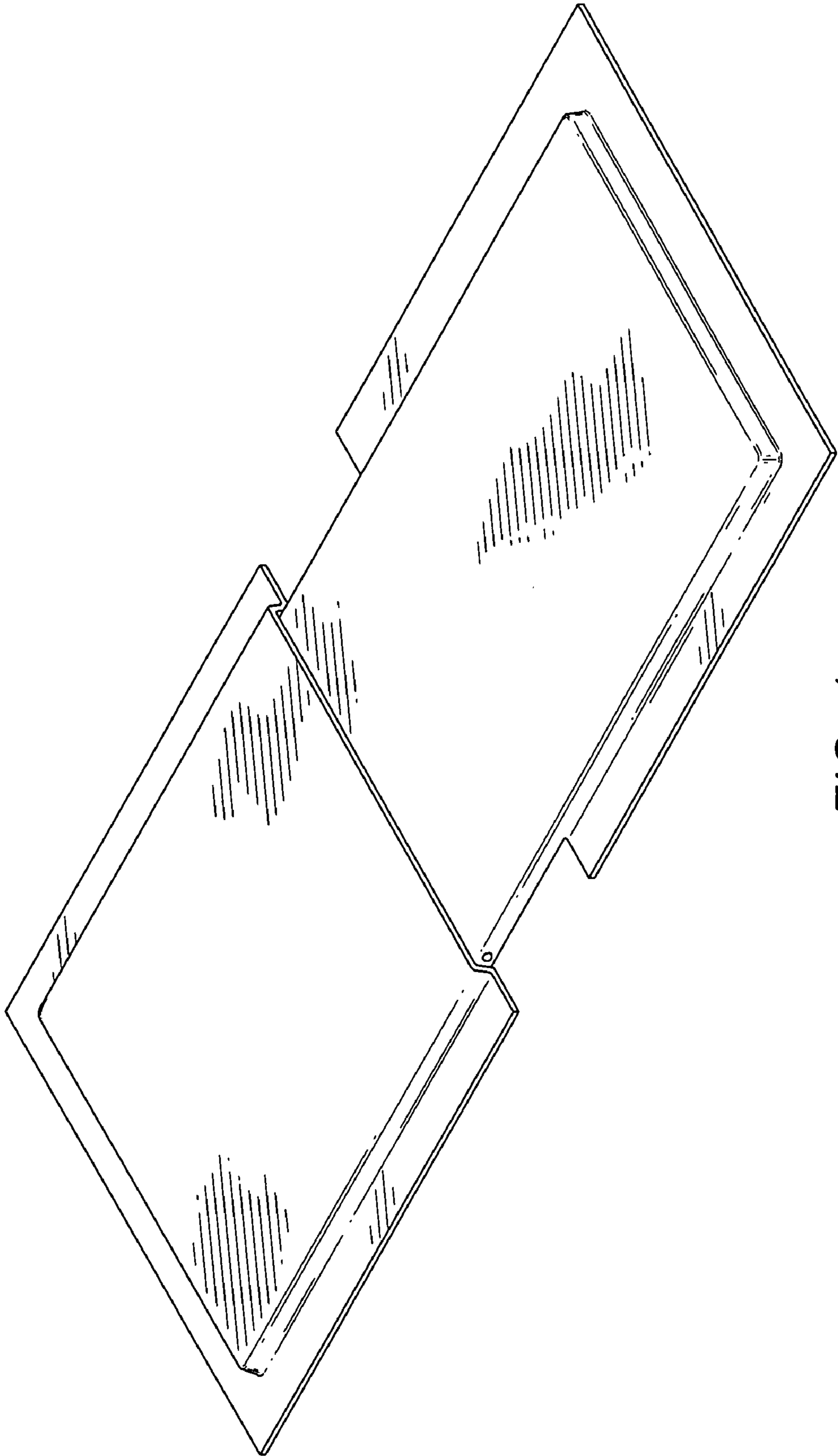

FIG. 1

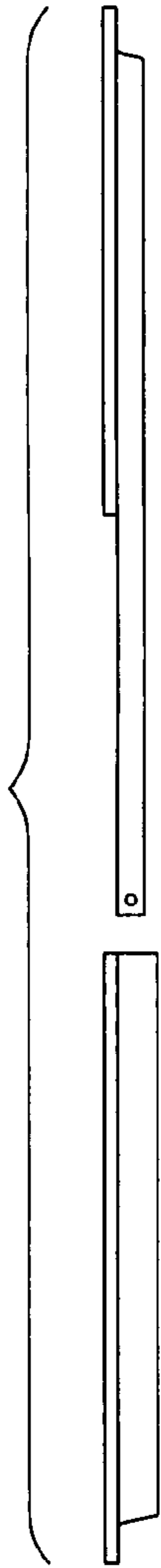

FIG. 3

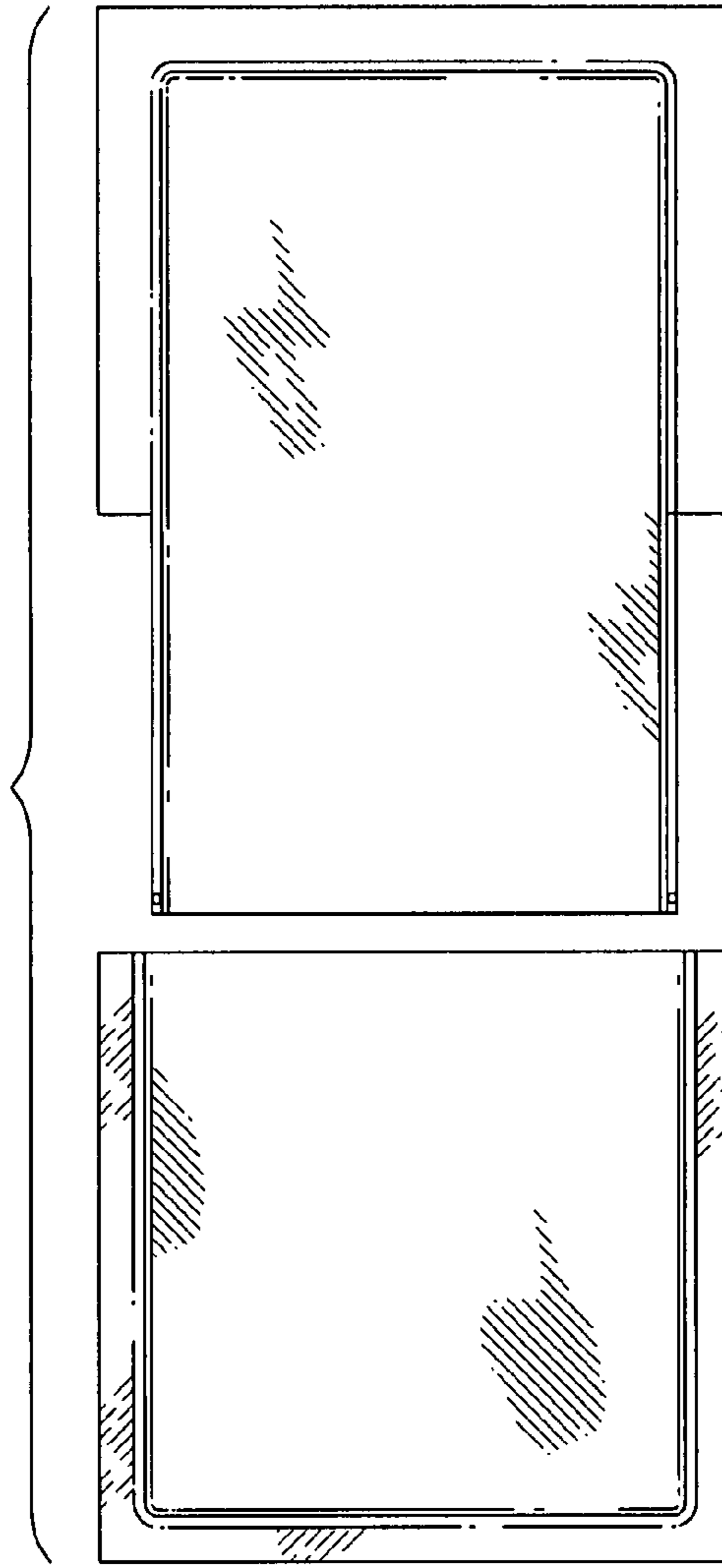

FIG. 2

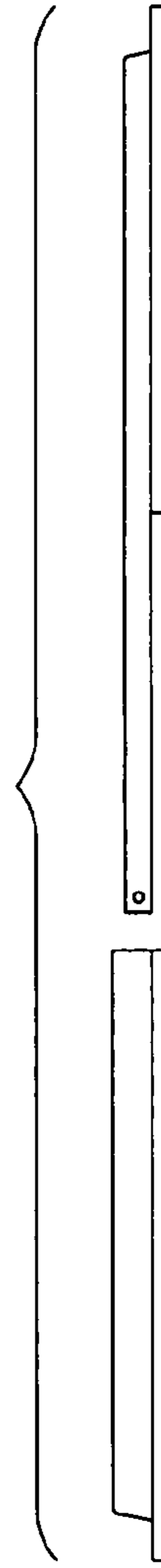

FIG. 4

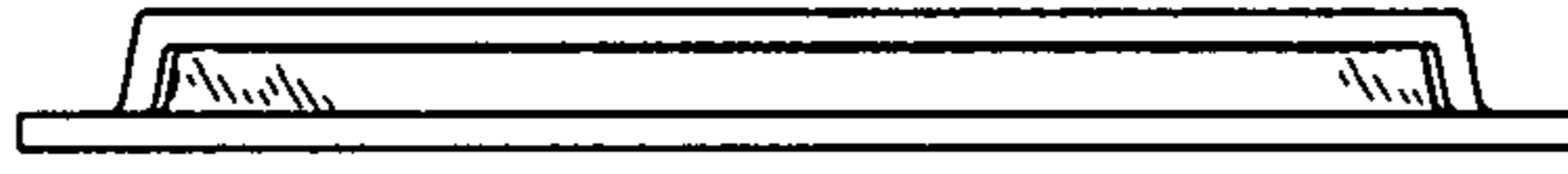

FIG. 7

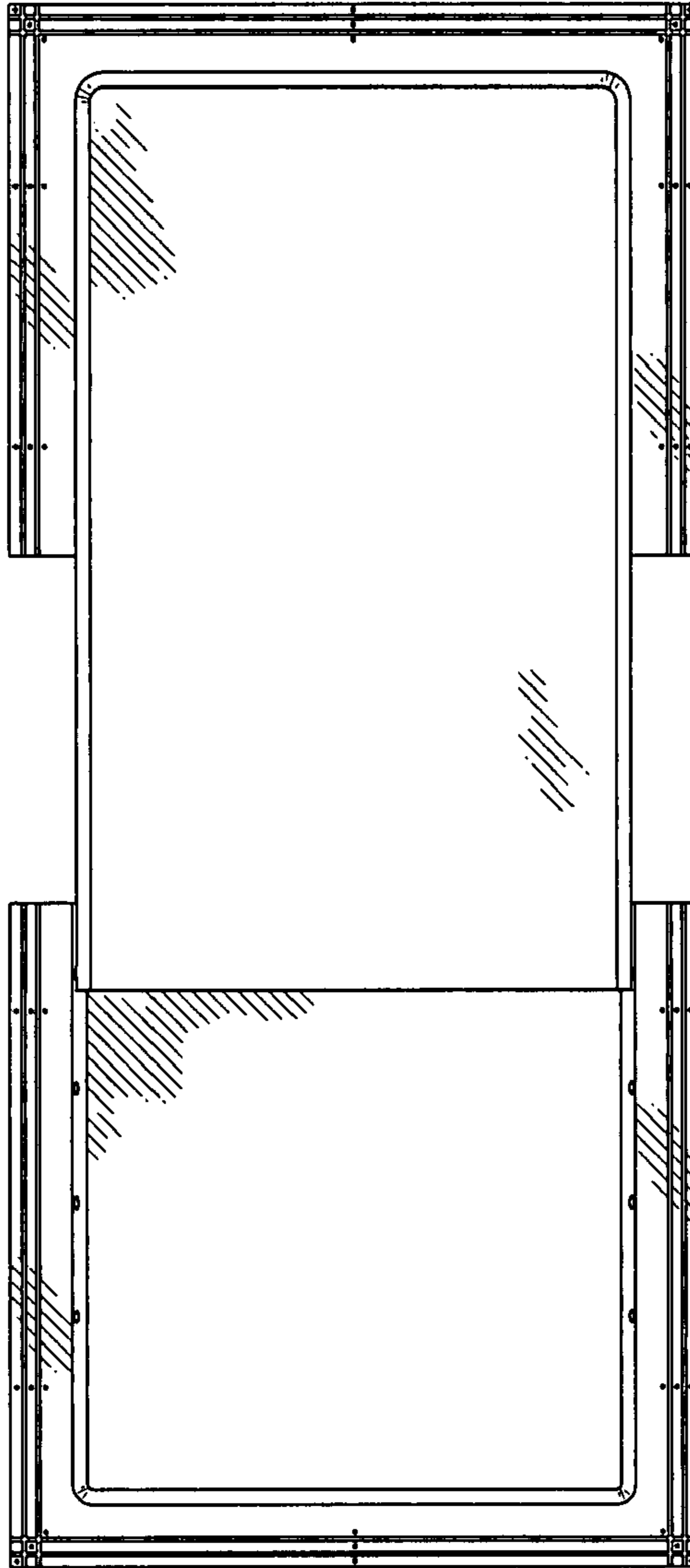

FIG. 5

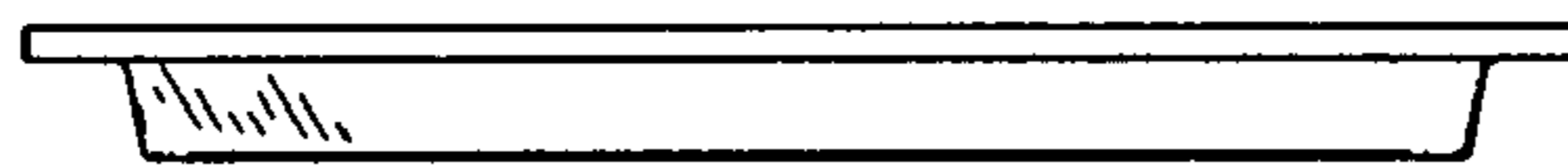

FIG. 6