



US00D555213S

(12) **United States Design Patent**
Bowen et al.

(10) **Patent No.:** **US D555,213 S**

(45) **Date of Patent:** **** Nov. 13, 2007**

(54) **INSECT TOY**

(75) Inventors: **David S. Bowen**, Fort Collins, CO
(US); **Paulo Kang**, Pasadena, CA (US)

(73) Assignee: **Mattel, Inc.**, El Segundo, CA (US)

(**) Term: **14 Years**

(21) Appl. No.: **29/247,065**

(22) Filed: **May 26, 2006**

Related U.S. Application Data

(63) Continuation-in-part of application No. 29/253,166, filed on Jan. 31, 2006, and a continuation-in-part of application No. 29/252,003, filed on Jan. 17, 2006, and a continuation-in-part of application No. 29/251,622, filed on Jan. 10, 2006.

(51) **LOC (8) Cl.** **21-01**

(52) **U.S. Cl.** **D21/578; D21/650**

(58) **Field of Classification Search** D21/576-578,
D21/584-592, 595, 650; D11/158; 446/72,
446/97-98, 268-269, 321, 368-369
See application file for complete search history.

(56) **References Cited**

U.S. PATENT DOCUMENTS

4,629,440 A * 12/1986 McKittrick et al. 446/356

D291,711 S * 9/1987 Dixon D21/650
5,310,378 A * 5/1994 Shannon 446/268
D517,131 S * 3/2006 Carruth D21/592

OTHER PUBLICATIONS

Small World Toys 1995 Catalog, p. 36, Creepy Crawler beetle.*

* cited by examiner

Primary Examiner—Sandra L. Morris

(74) *Attorney, Agent, or Firm*—Akin Gump Strauss Hauer & Feld LLP

(57) **CLAIM**

The ornamental design for an insect toy, as shown and described.

DESCRIPTION

FIG. 1 is a perspective view of the top, front and left side of an insect toy in accordance with a first preferred embodiment of our new design;

FIG. 2 is a front elevation view thereof;

FIG. 3 is a rear elevation view thereof;

FIG. 4 an elevation view of the left side thereof, the right side being a mirror image;

FIG. 5 is a top plan view thereof; and,

FIG. 6 is a bottom plan view thereof.

1 Claim, 5 Drawing Sheets

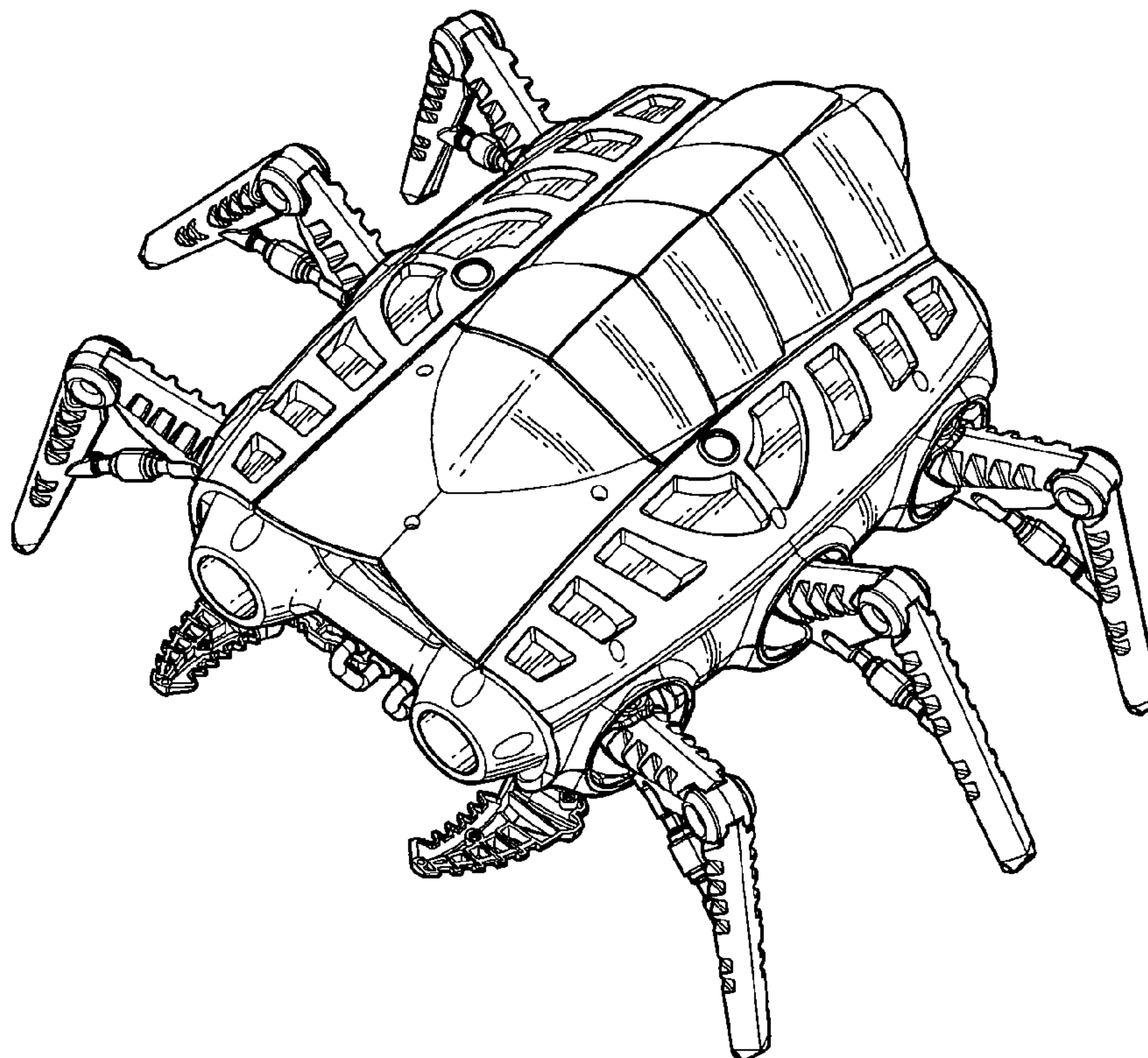

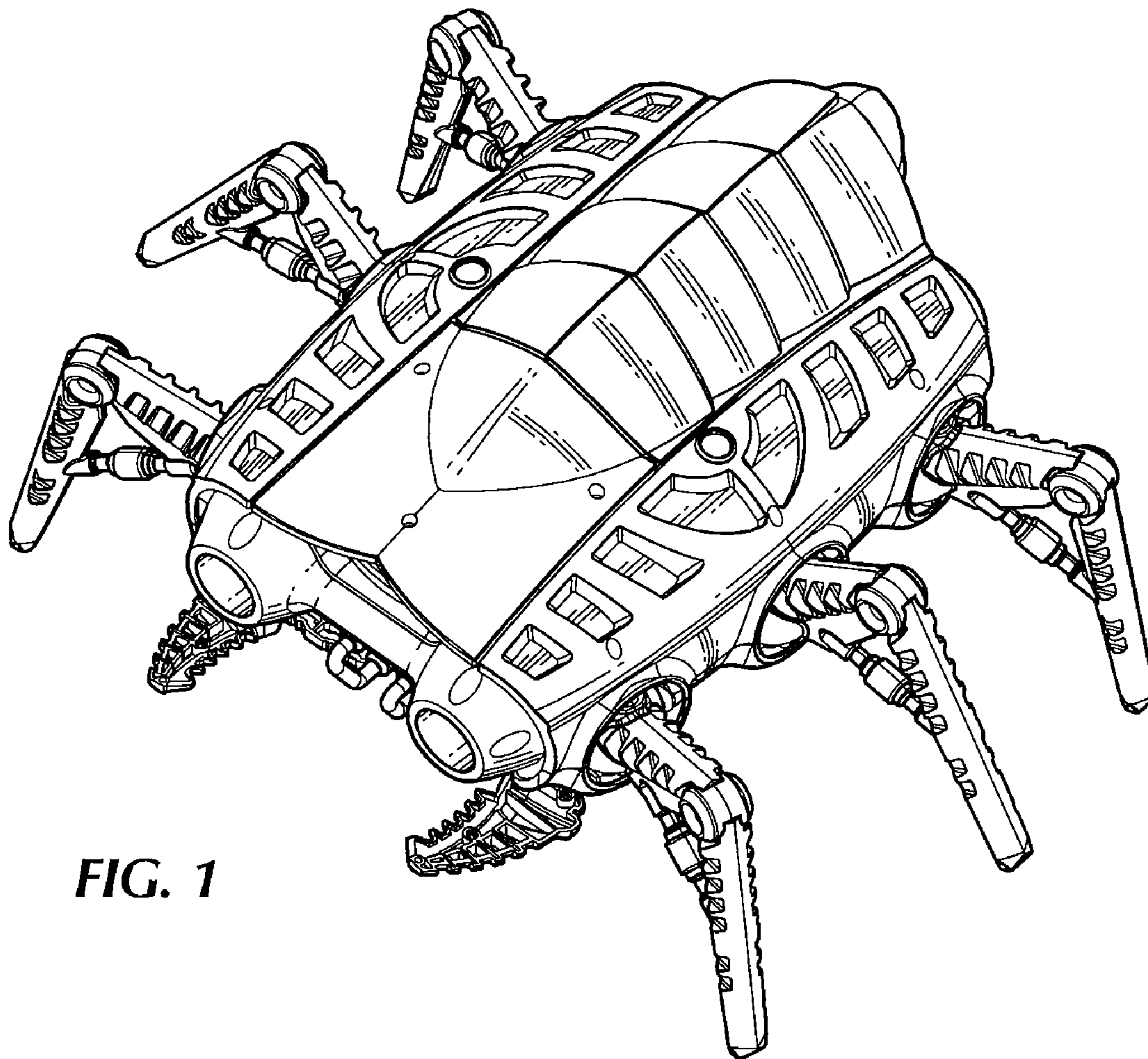

FIG. 1

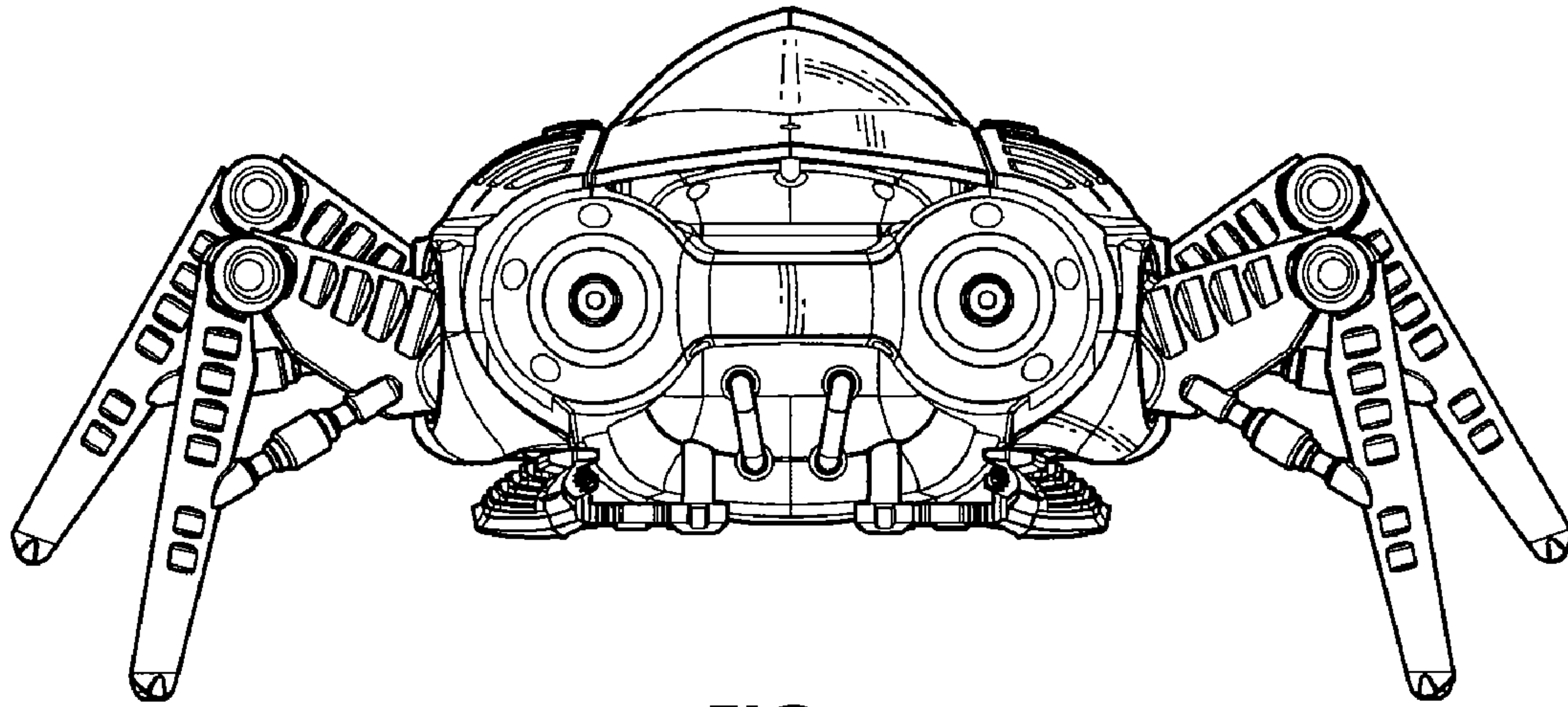

FIG. 2

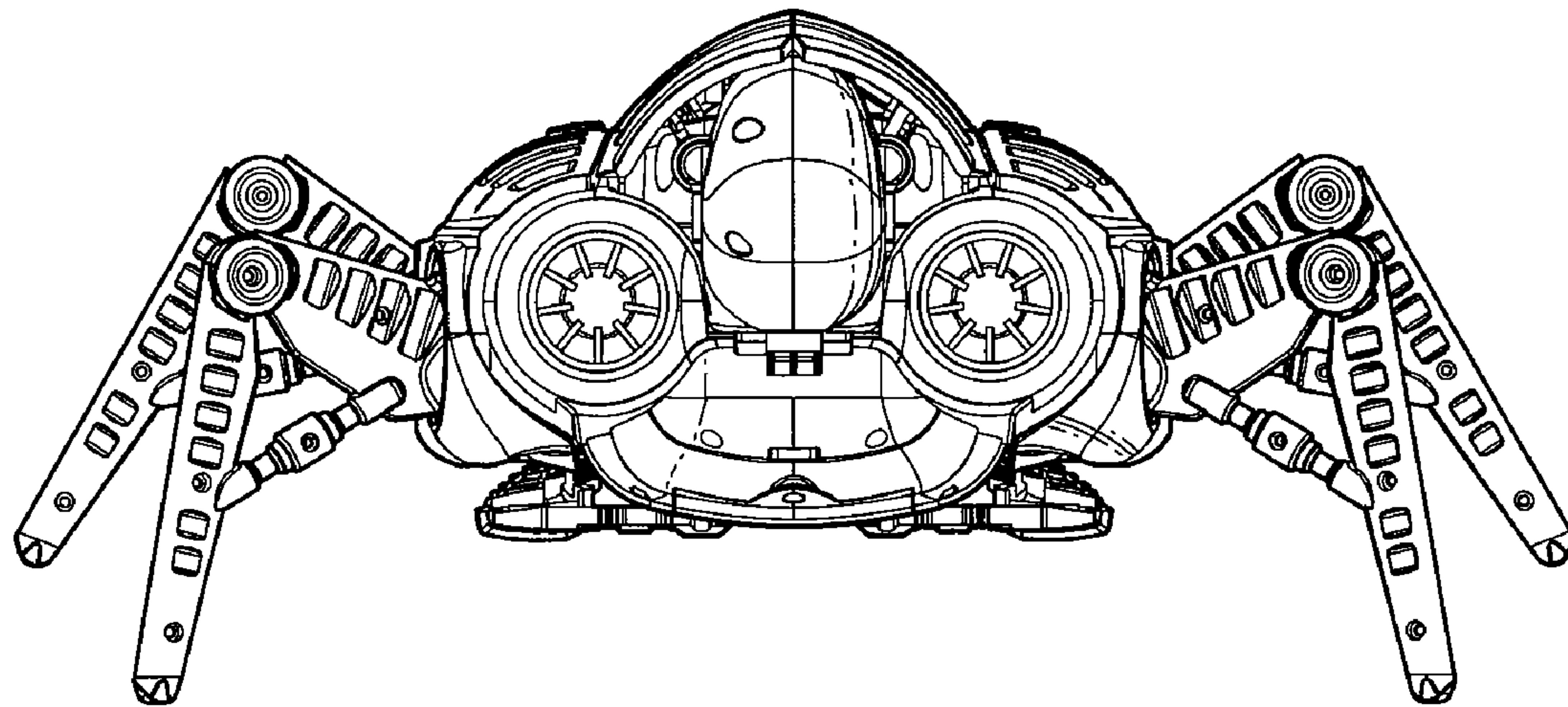

FIG. 3

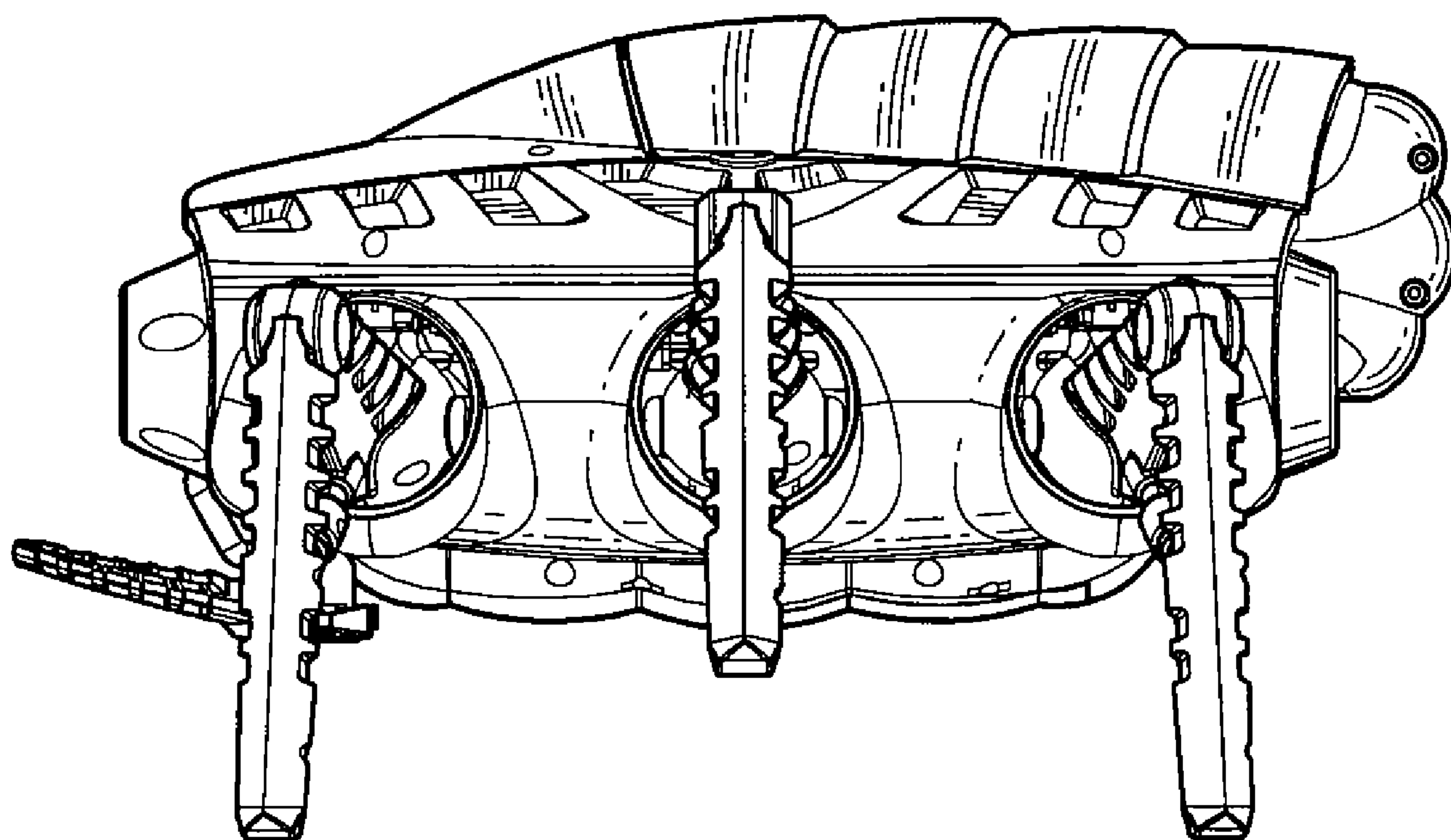

FIG. 4

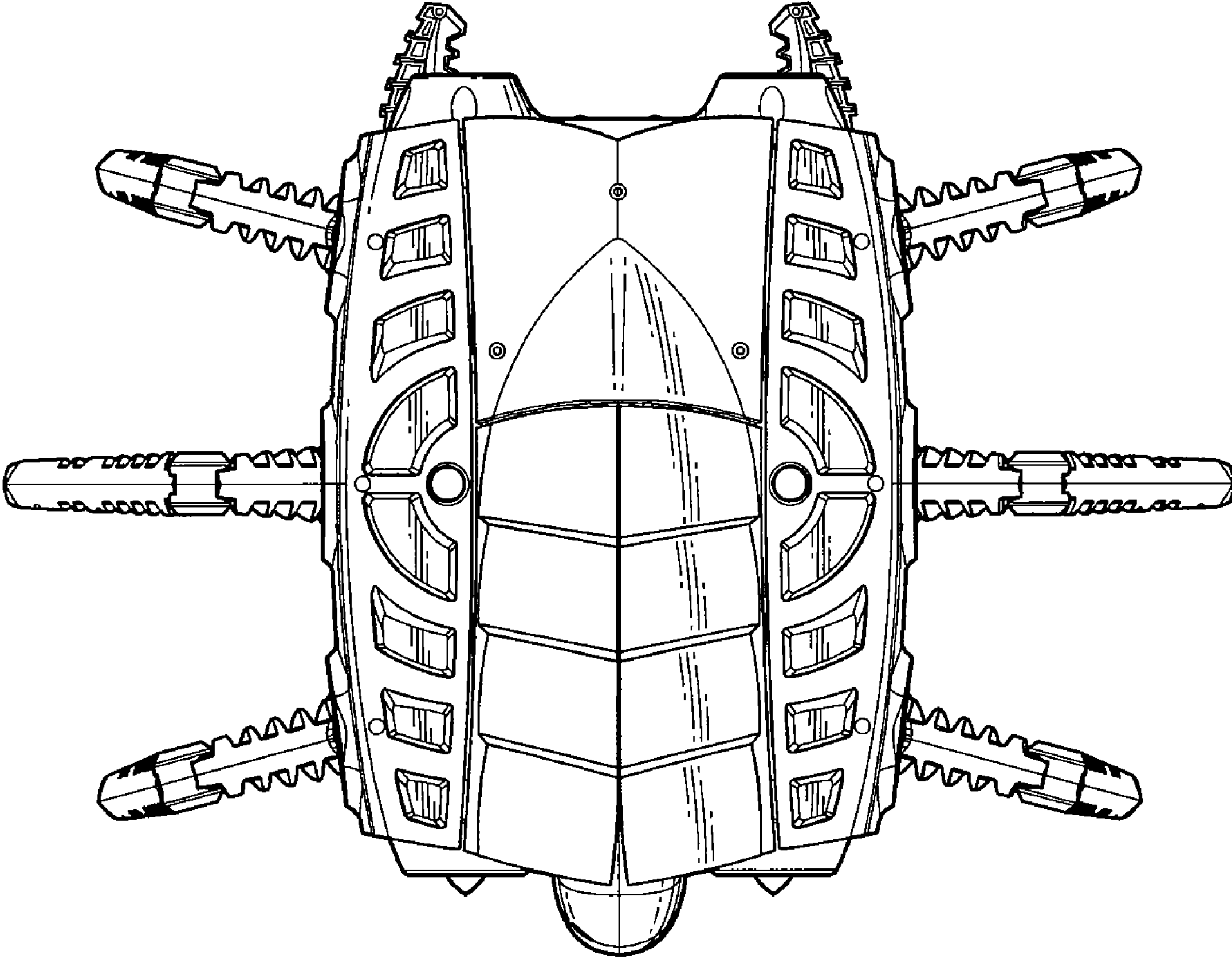

FIG. 5

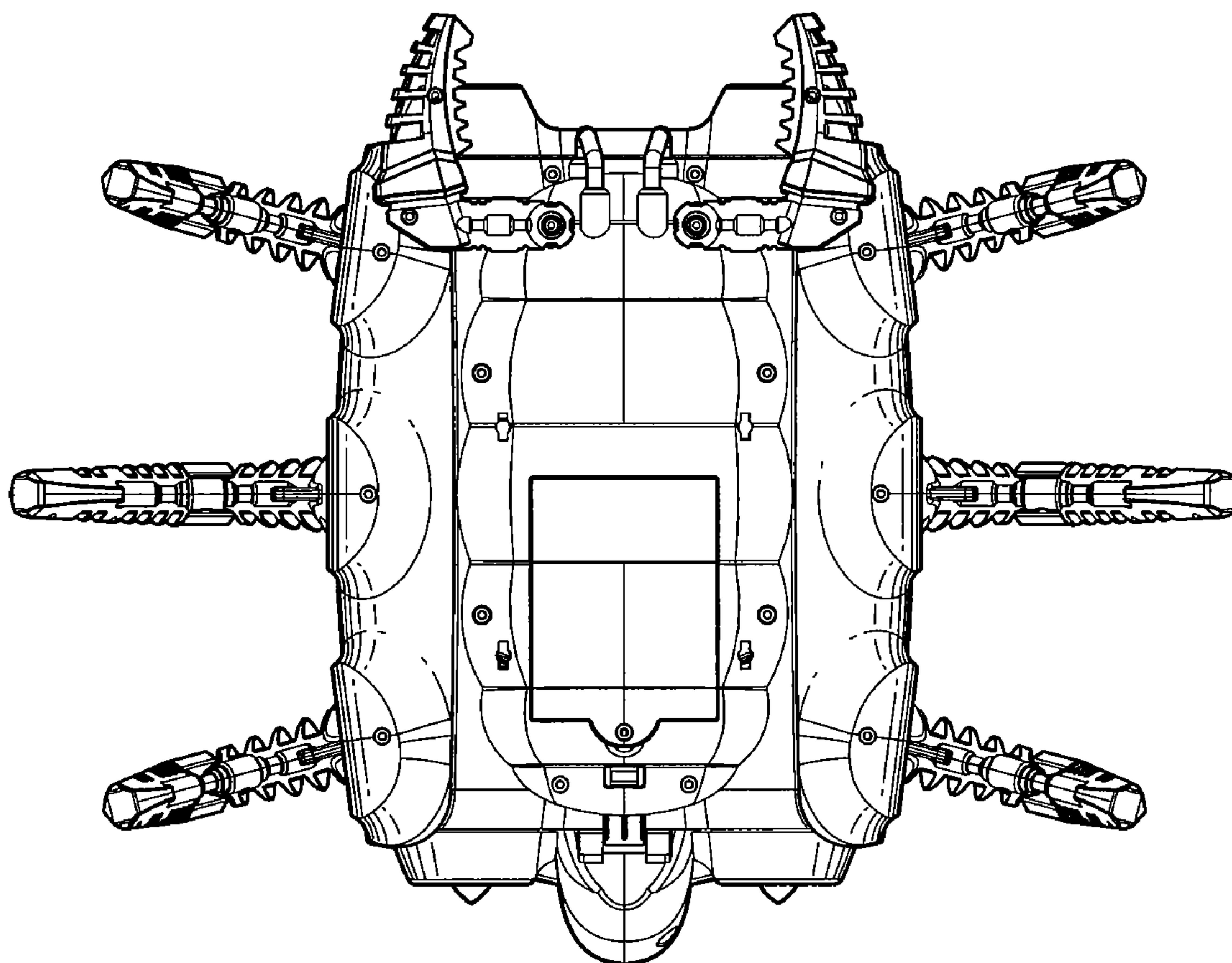

FIG. 6