

US00D555156S

(12) **United States Design Patent**  
**Quilling**

(10) **Patent No.:** **US D555,156 S**

(45) **Date of Patent:** **\*\* Nov. 13, 2007**

(54) **AUTO STEREO MOUNTING DEVICE**

D545,661 S \* 7/2007 Quilling, II ..... D14/258

(76) Inventor: **R. Spencer Quilling**, 2100 Lemon St.,  
DeLand, FL (US) 32720

\* cited by examiner

(\*\*) Term: **14 Years**

*Primary Examiner*—Robert M. Spear

*Assistant Examiner*—Katrina A Kile

(74) *Attorney, Agent, or Firm*—John Wiley Horton

(21) Appl. No.: **29/286,104**

(22) Filed: **Apr. 24, 2007**

(57) **CLAIM**

The ornamental design for an “auto stereo mounting device”, as shown and described.

(51) **LOC (8) Cl.** ..... **14-01**

(52) **U.S. Cl.** ..... **D14/258**

(58) **Field of Classification Search** ..... D14/258,  
D14/257, 224, 217, 198, 197, 193, 192, 188,  
D14/168, 167, 165, 164, 163, 162, 161, 160,  
D14/157, 156, 154, 136, 135; 720/691, 658,  
720/270; 455/344, 575.1; 396/434, 93;  
386/1; 369/93, 75.1; 360/47, 4; 359/550,  
359/258; 349/460, 159, 10

See application file for complete search history.

**DESCRIPTION**

FIG. 1 is a perspective view of an auto stereo mounting device, showing my design;

FIG. 2 is a front elevation view of FIG. 1;

FIG. 3 is a rear elevation view of FIG. 1;

FIG. 4 is a right side elevation view of FIG. 1;

FIG. 5 is a left side elevation view of FIG. 1;

FIG. 6 is a top plan view of FIG. 1; and,

FIG. 7 is a bottom plan view of FIG. 1.

The broken lines shown in all views illustrate mounting features which form no part of the claimed design.

(56) **References Cited**

**U.S. PATENT DOCUMENTS**

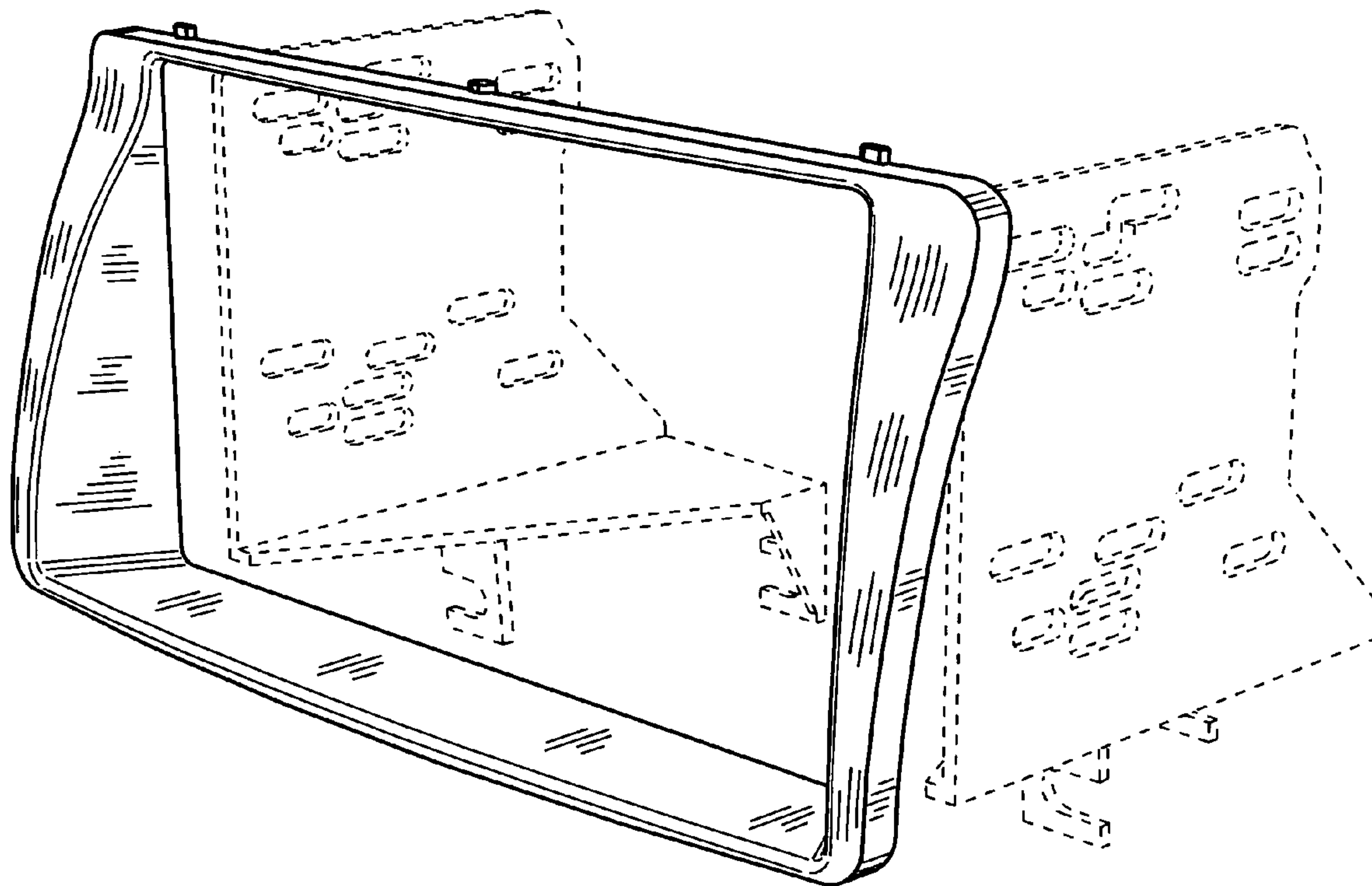
D418,838 S \* 1/2000 Jones et al. .... D14/224

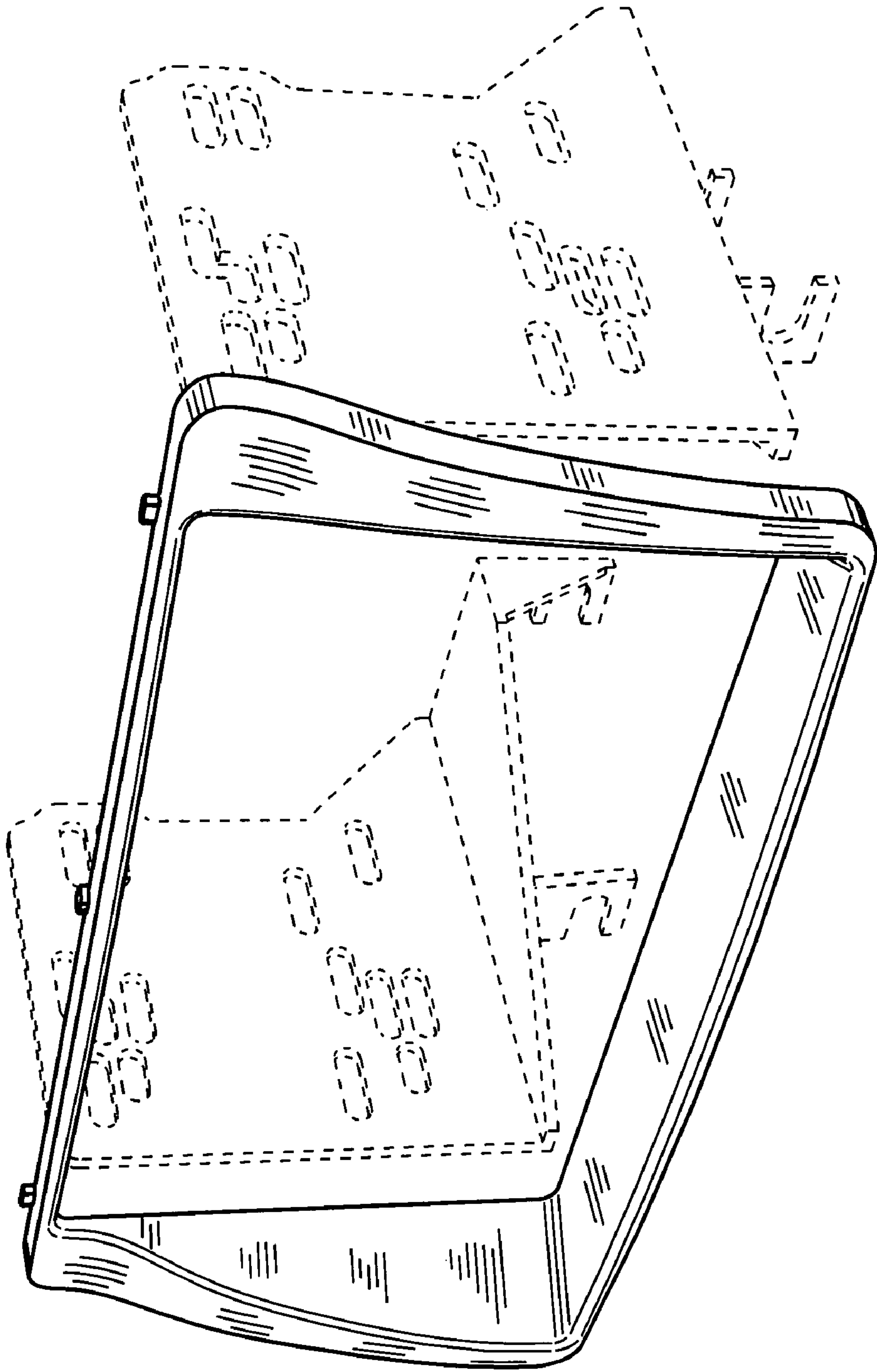
D482,023 S \* 11/2003 Quilling et al. .... D14/224

D484,495 S \* 12/2003 Quilling et al. .... D14/224

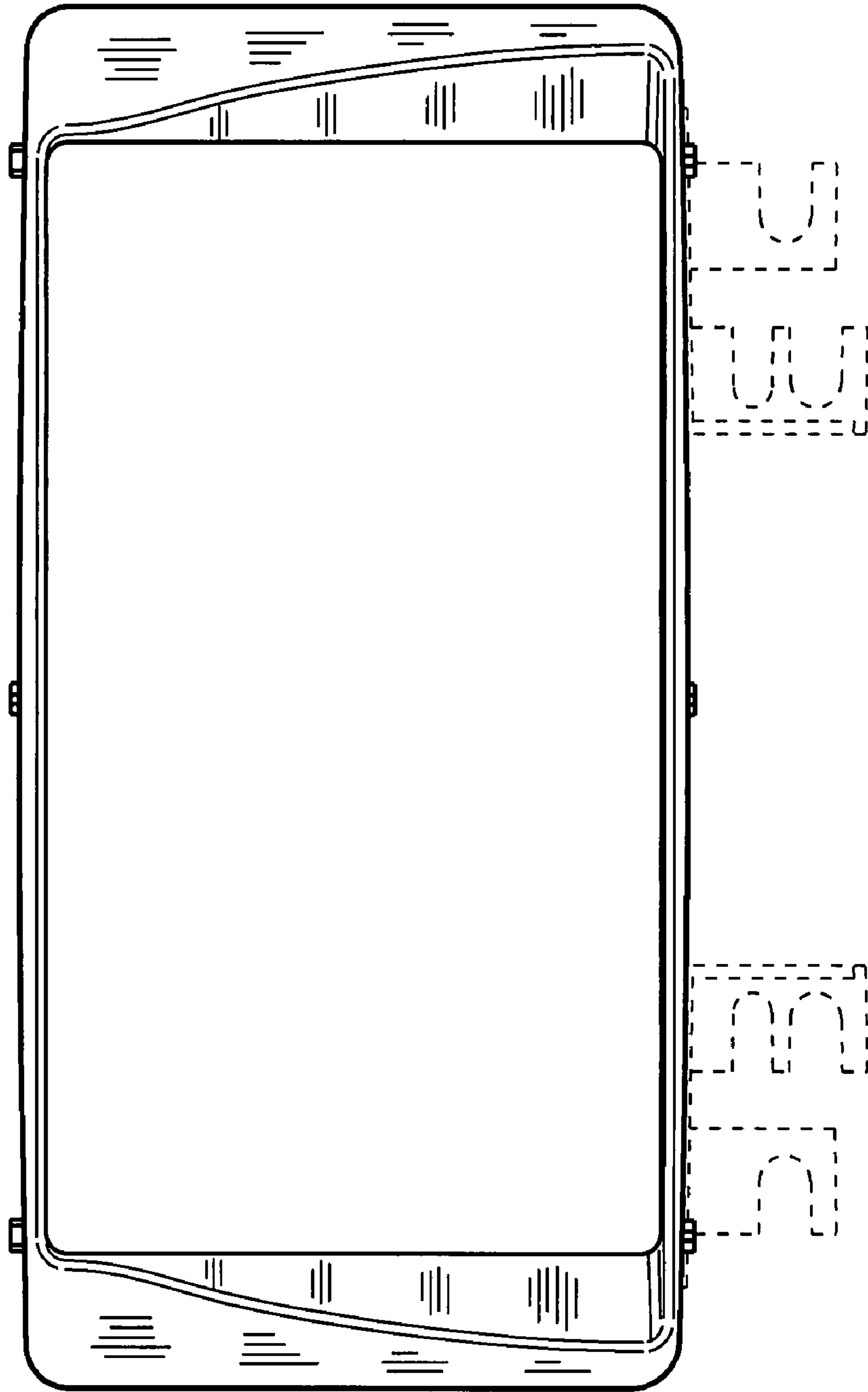
D488,462 S \* 4/2004 Quilling et al. .... D14/224

**1 Claim, 7 Drawing Sheets**

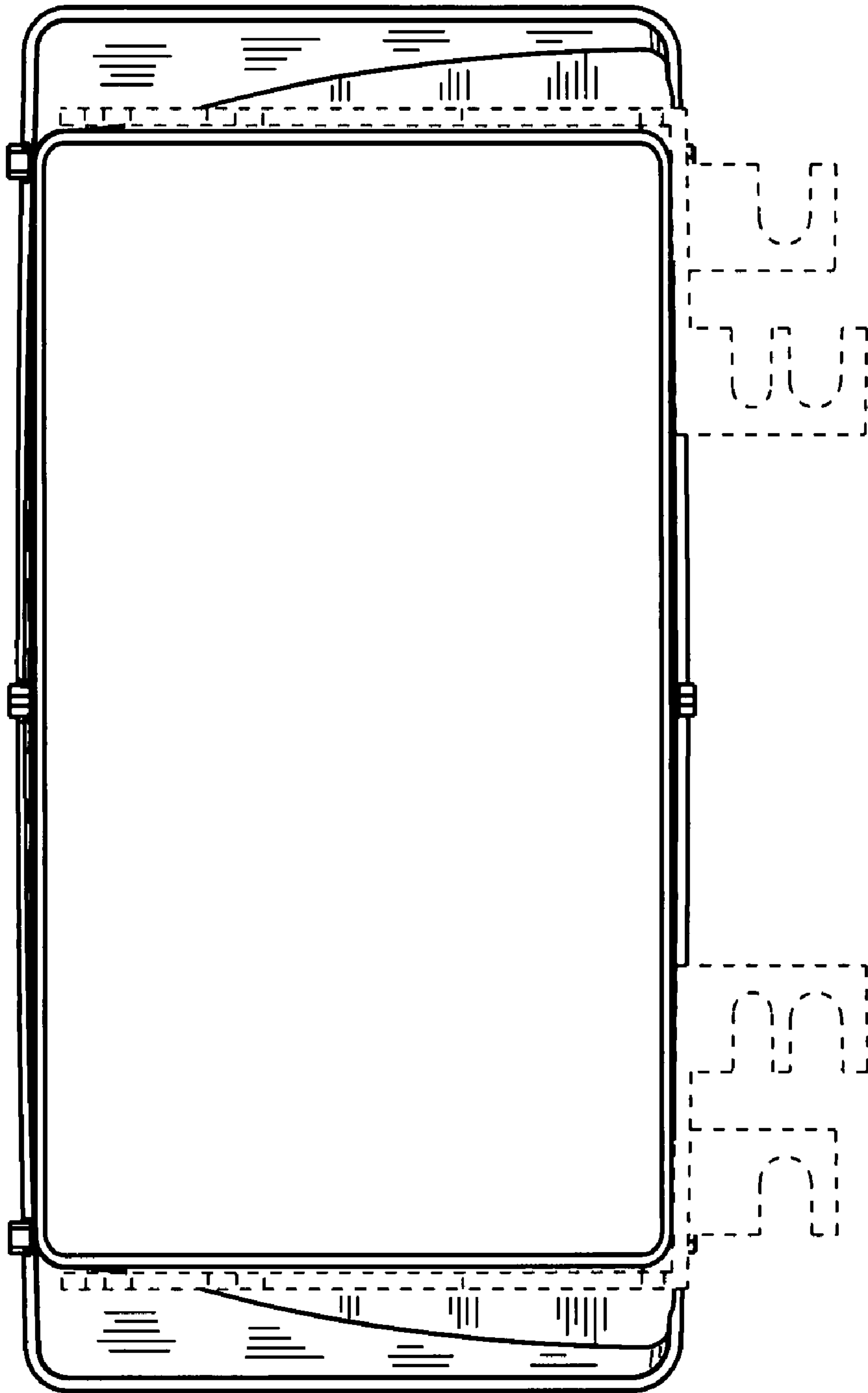




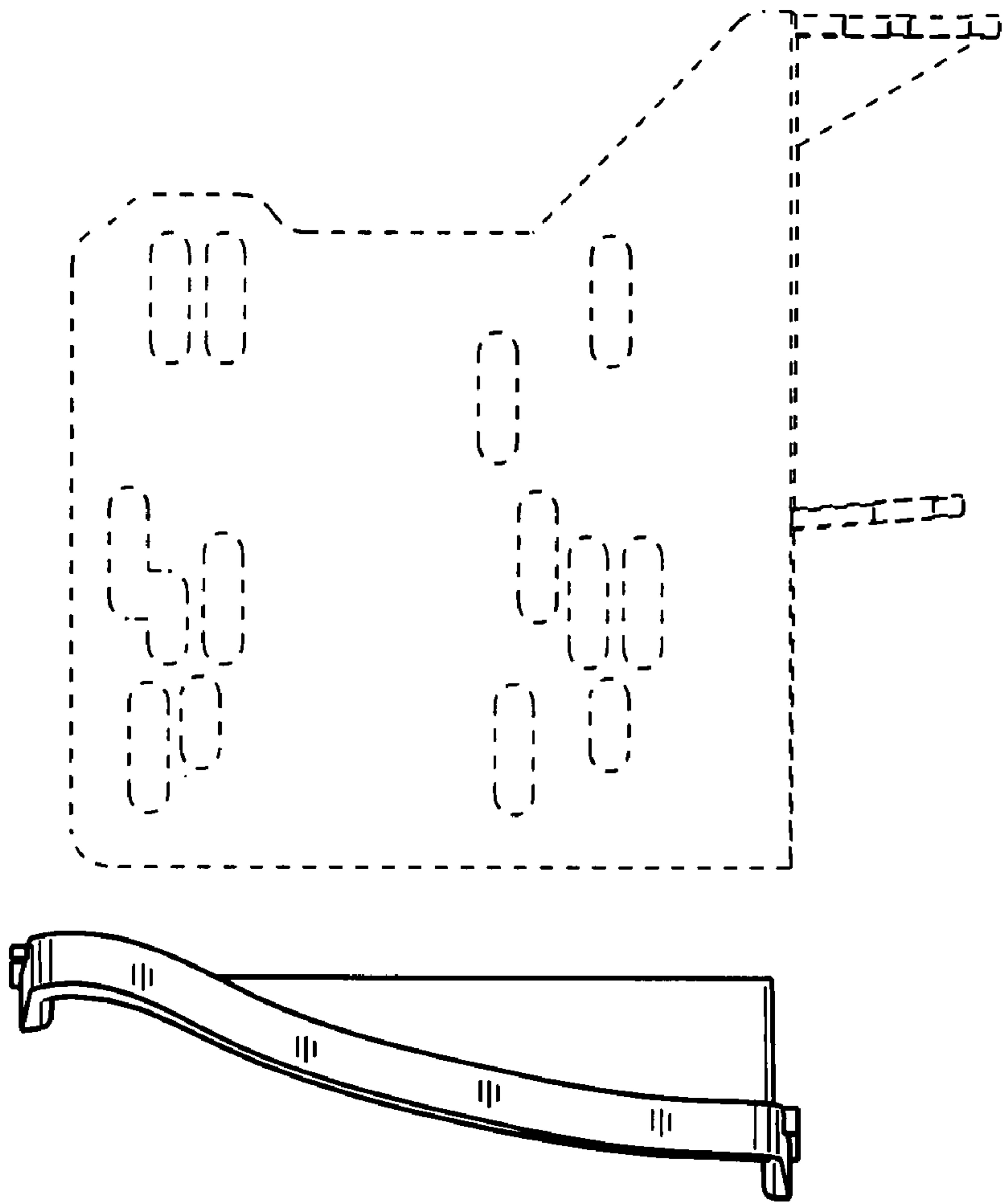
**FIG. 1**



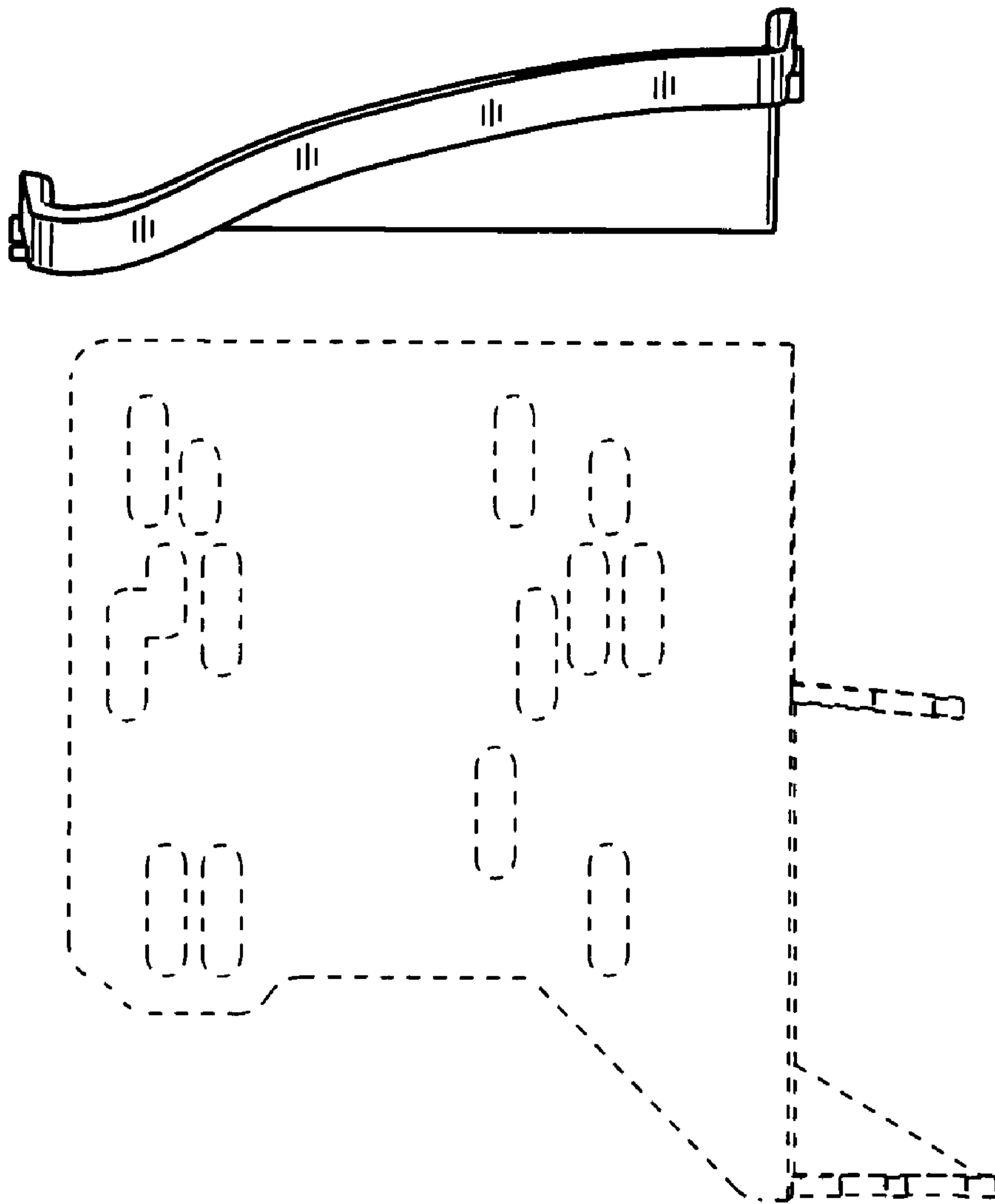
**FIG. 2**



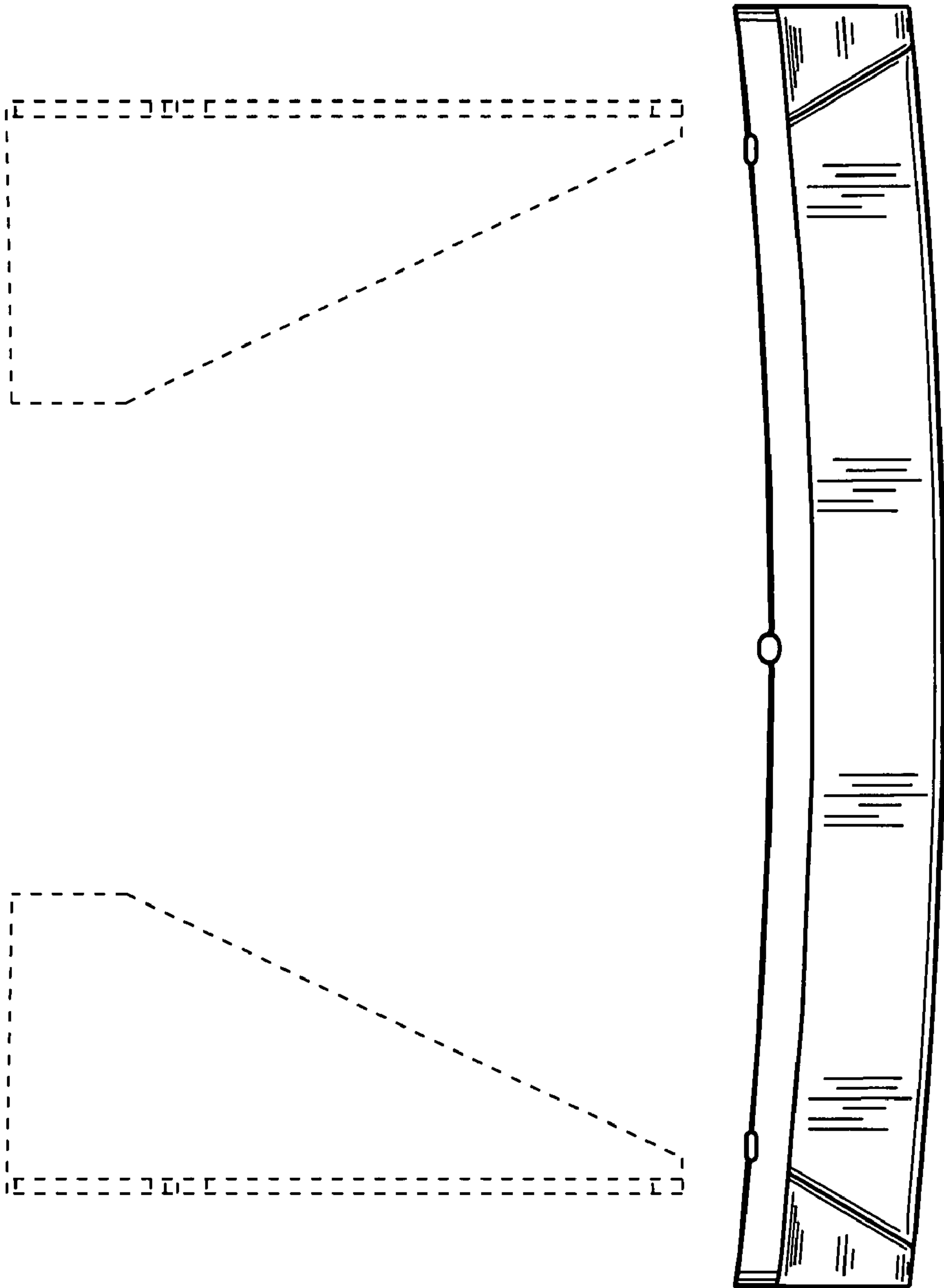
**FIG. 3**



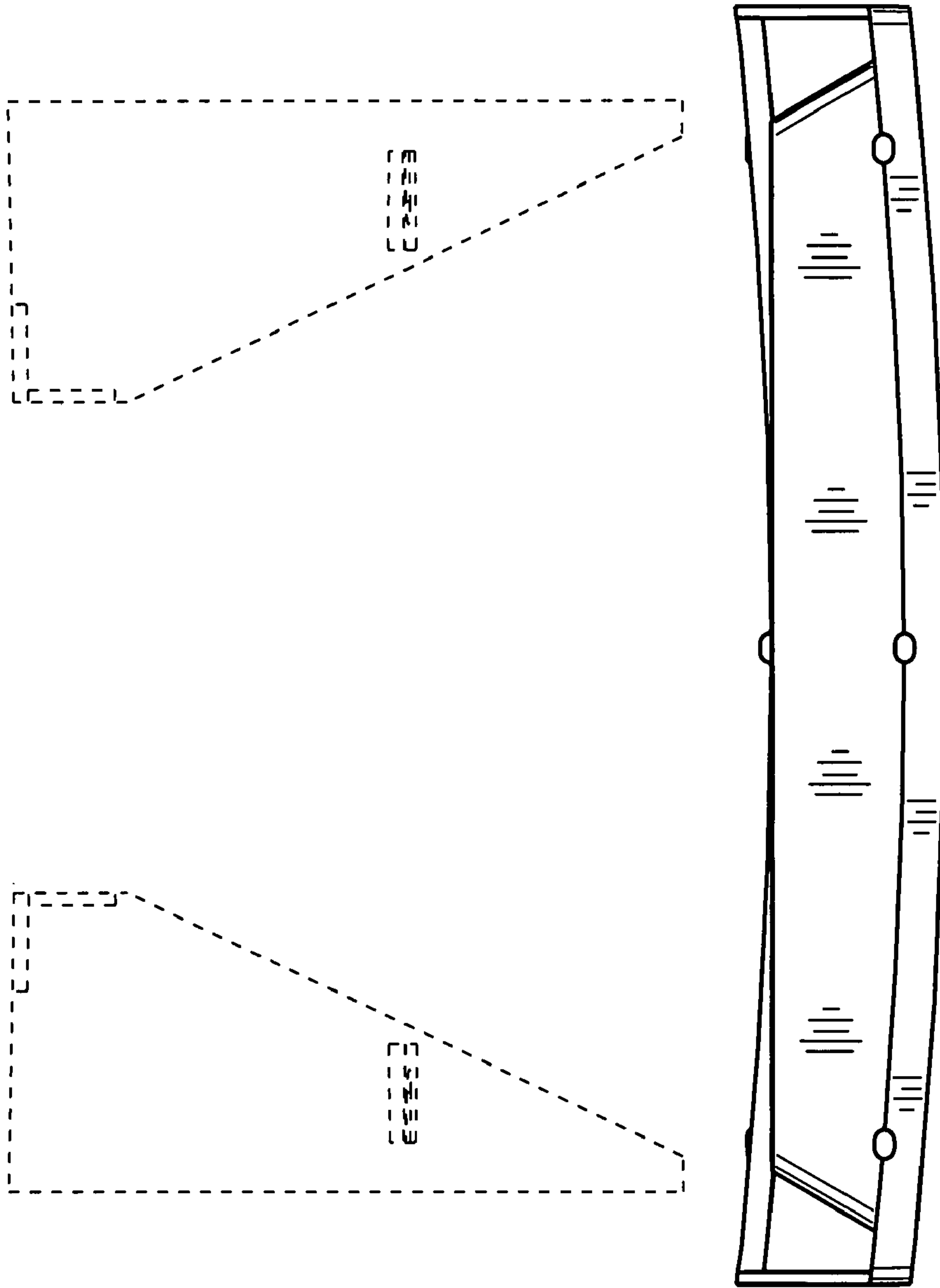
**FIG. 4**



**FIG. 5**



**FIG. 6**



**FIG. 7**