



US00D555148S

(12) **United States Design Patent** (10) **Patent No.:** **US D555,148 S**
Mittersinker et al. (45) **Date of Patent:** **** Nov. 13, 2007**

(54) **HOUSING FOR DOCK AND MIXER FOR MEDIA PLAYERS**

D535,614 S * 1/2007 Majanen et al. D13/108
D543,162 S * 5/2007 Kim D14/125
2006/0221776 A1* 10/2006 Roman et al. 369/1

(75) Inventors: **Gregor Mittersinker**, Warwick, RI (US); **Michael Leighton**, Sunprairie, WI (US)

OTHER PUBLICATIONS

Create Digital Music, "Analysis:Prototype Numark iPod DJ Mixer", <http://createdigitalmusic.com/2005/04/14/analysis-prototype-numark-ipod-dj-mixer/>, Apr. 14, 2005, 1pg.*

(73) Assignee: **Numark Industries, LLC**, Cumberland, RI (US)

* cited by examiner

(**) Term: **14 Years**

Primary Examiner—Stella Reid
Assistant Examiner—Keli' L. Acker

(21) Appl. No.: **29/246,087**

(74) *Attorney, Agent, or Firm*—Barlow, Josephs & Holmes, Ltd.

(22) Filed: **Feb. 2, 2006**

(57) **CLAIM**

(51) **LOC (8) Cl.** **14-01**

The ornamental design for a housing for dock and mixer for media players, as shown and described.

(52) **U.S. Cl.** **D14/217**

(58) **Field of Classification Search** D14/156, D14/162, 167, 168, 188, 196–198, 217, 257, D14/258; D13/163, 164; 85/625, 660, 697; 381/118–120, 334; 455/350, 347

DESCRIPTION

FIG. 1 is a perspective view of a housing for dock and mixer for media players showing our new design;

See application file for complete search history.

FIG. 2 is a front elevational view thereof;

(56) **References Cited**

U.S. PATENT DOCUMENTS

D265,199 S *	6/1982	Urban et al.	D14/217
D273,950 S *	5/1984	Itoh et al.	D14/217
D325,910 S *	5/1992	Ito et al.	D14/162
D384,356 S *	9/1997	Ito et al.	D14/217
D423,503 S *	4/2000	Abdo	D14/188
D424,056 S *	5/2000	Ito et al.	D14/162
D433,673 S *	11/2000	Ito et al.	D14/217
D451,890 S *	12/2001	Reese et al.	D13/163
D454,855 S *	3/2002	Nakane	D14/168
D480,399 S *	10/2003	Takita et al.	D14/399
D495,336 S *	8/2004	Andre et al.	D14/434

FIG. 3 is a rear elevational view thereof;

FIG. 4 is a top view thereof;

FIG. 5 is a bottom view thereof;

FIG. 6 is a left side elevational view thereof; and,

FIG. 7 is a right side elevational view thereof.

The broken line showing of the portable media players, and example layout for buttons, knobs, sliders and jacks are included for the purpose of illustrating environmental structure and forms no part of the claimed design.

1 Claim, 7 Drawing Sheets

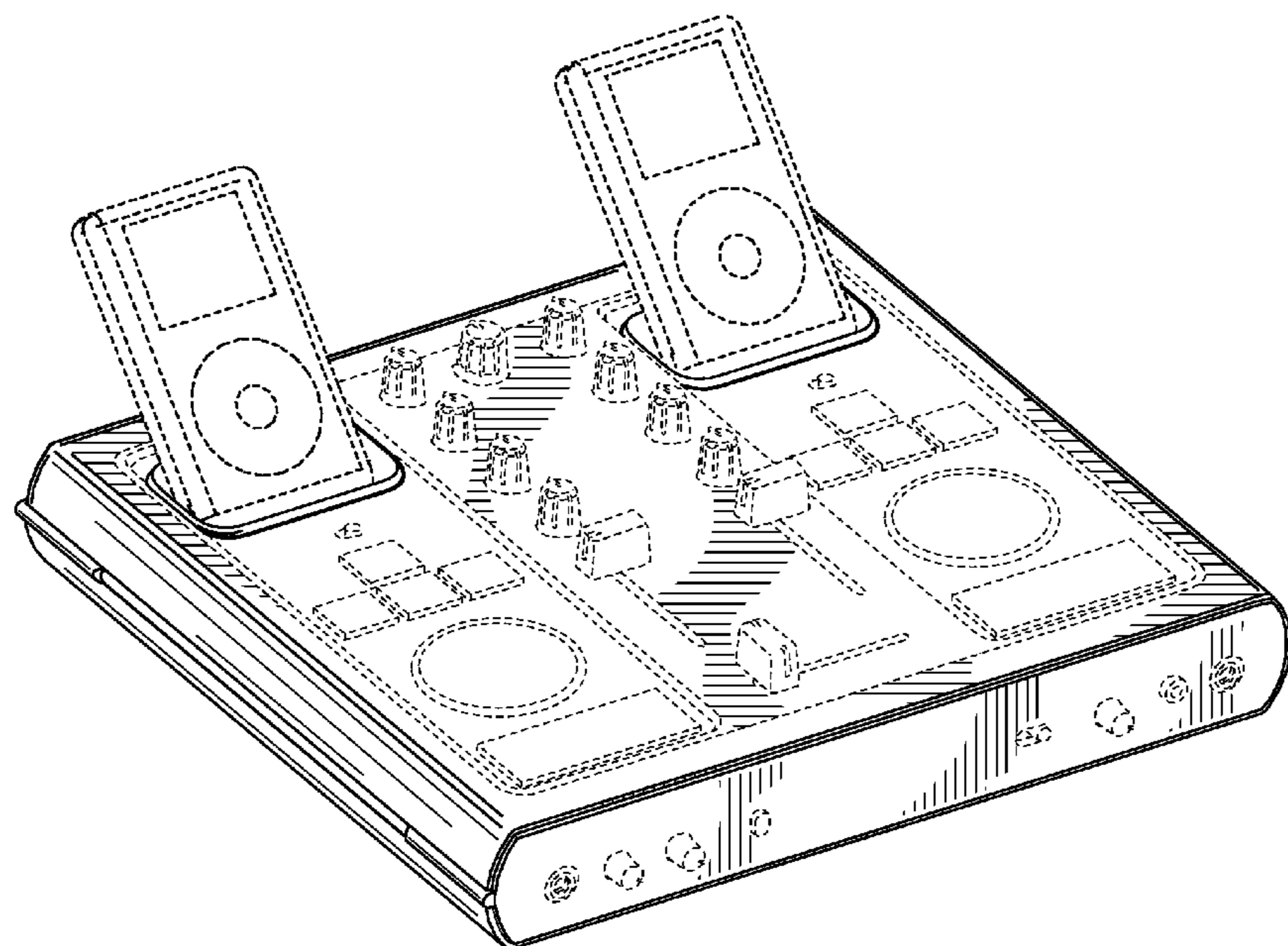

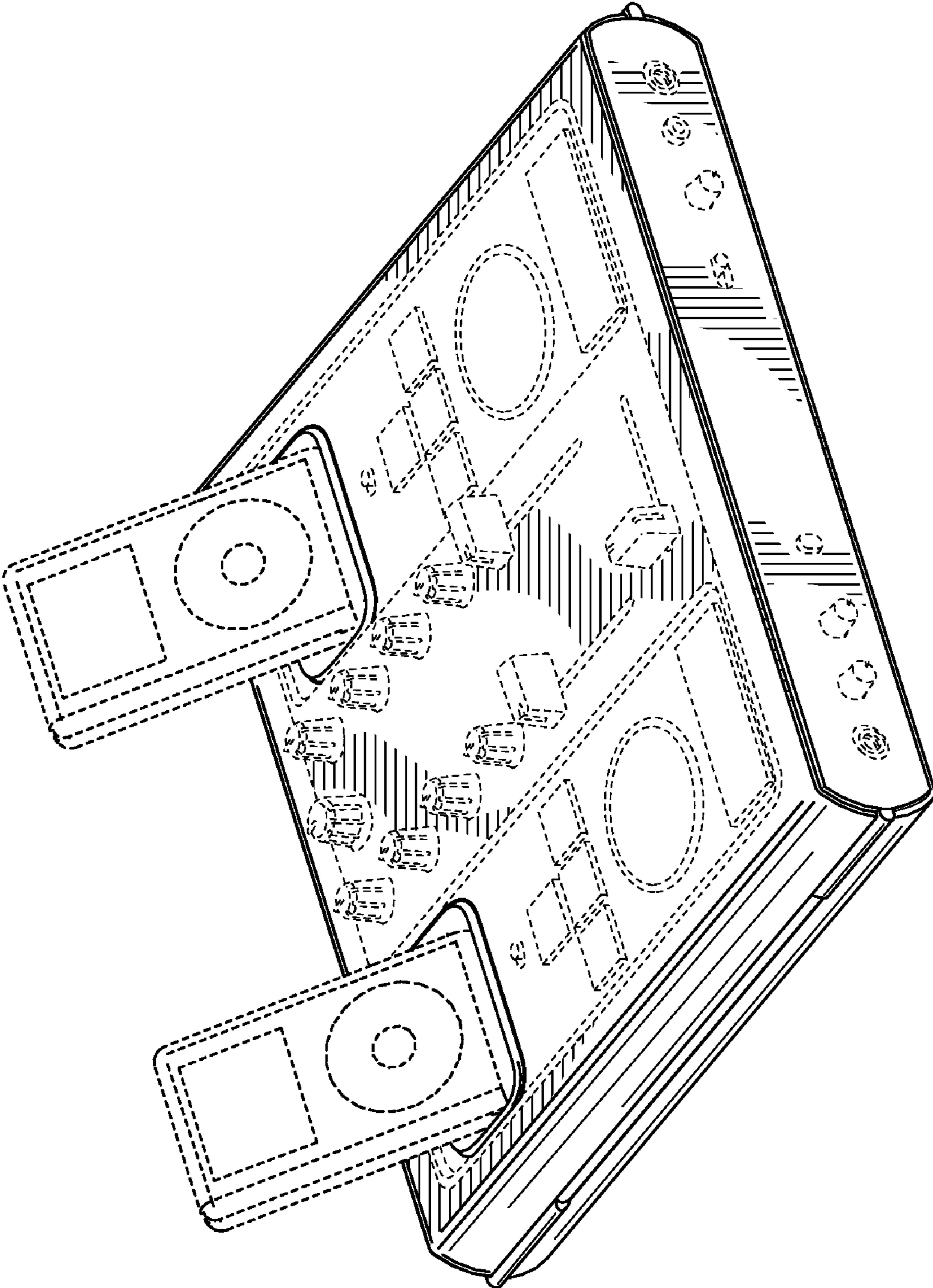

FIG. 1

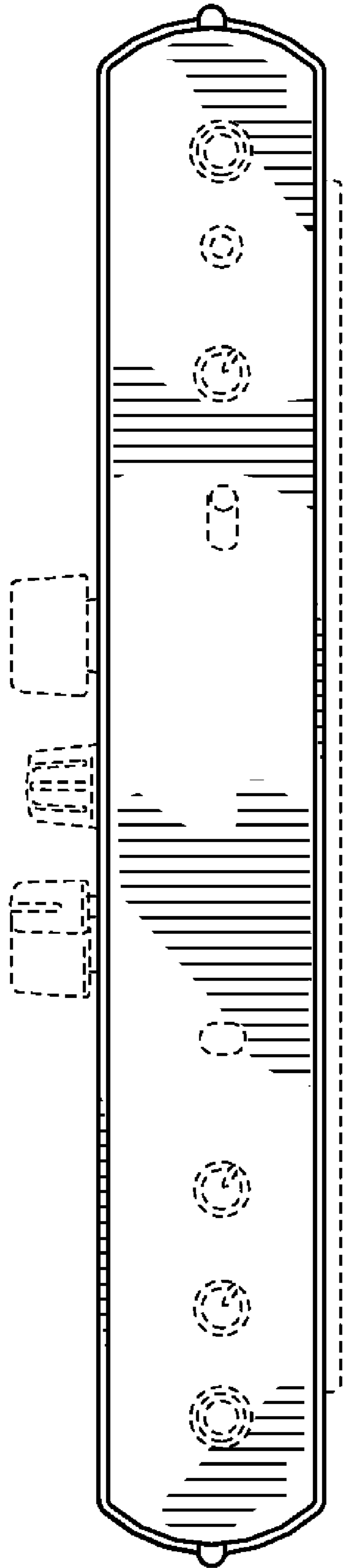

FIG. 2

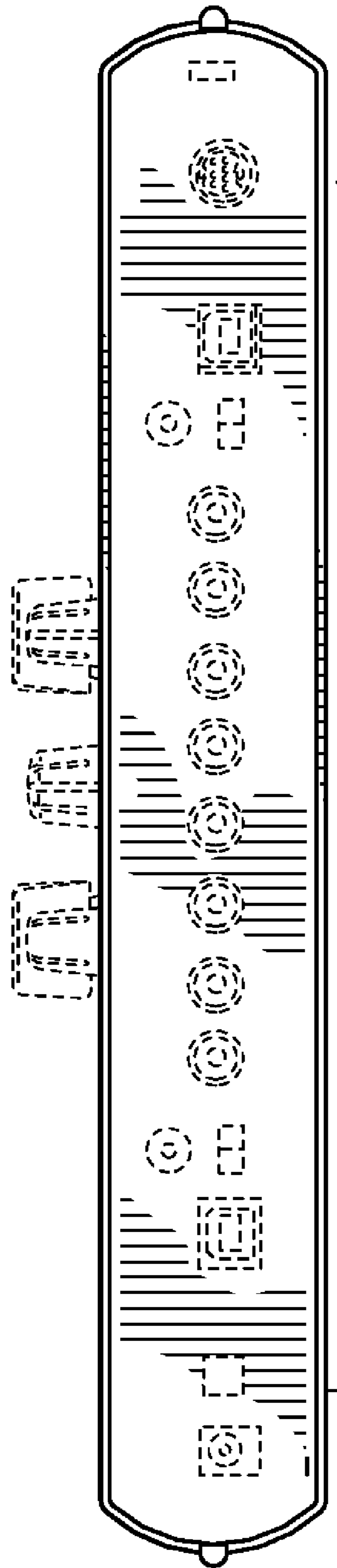

FIG. 3

FIG. 4

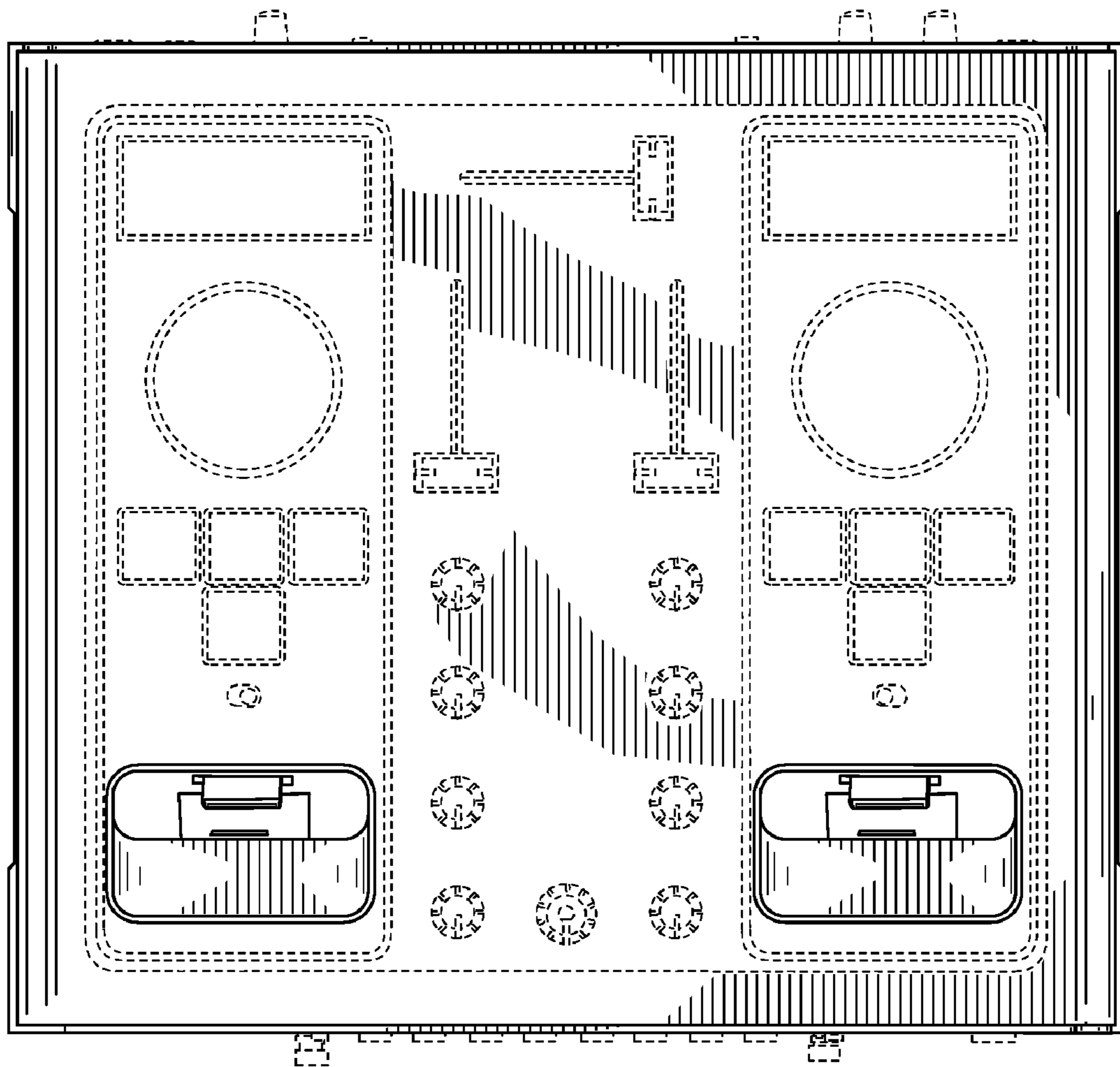
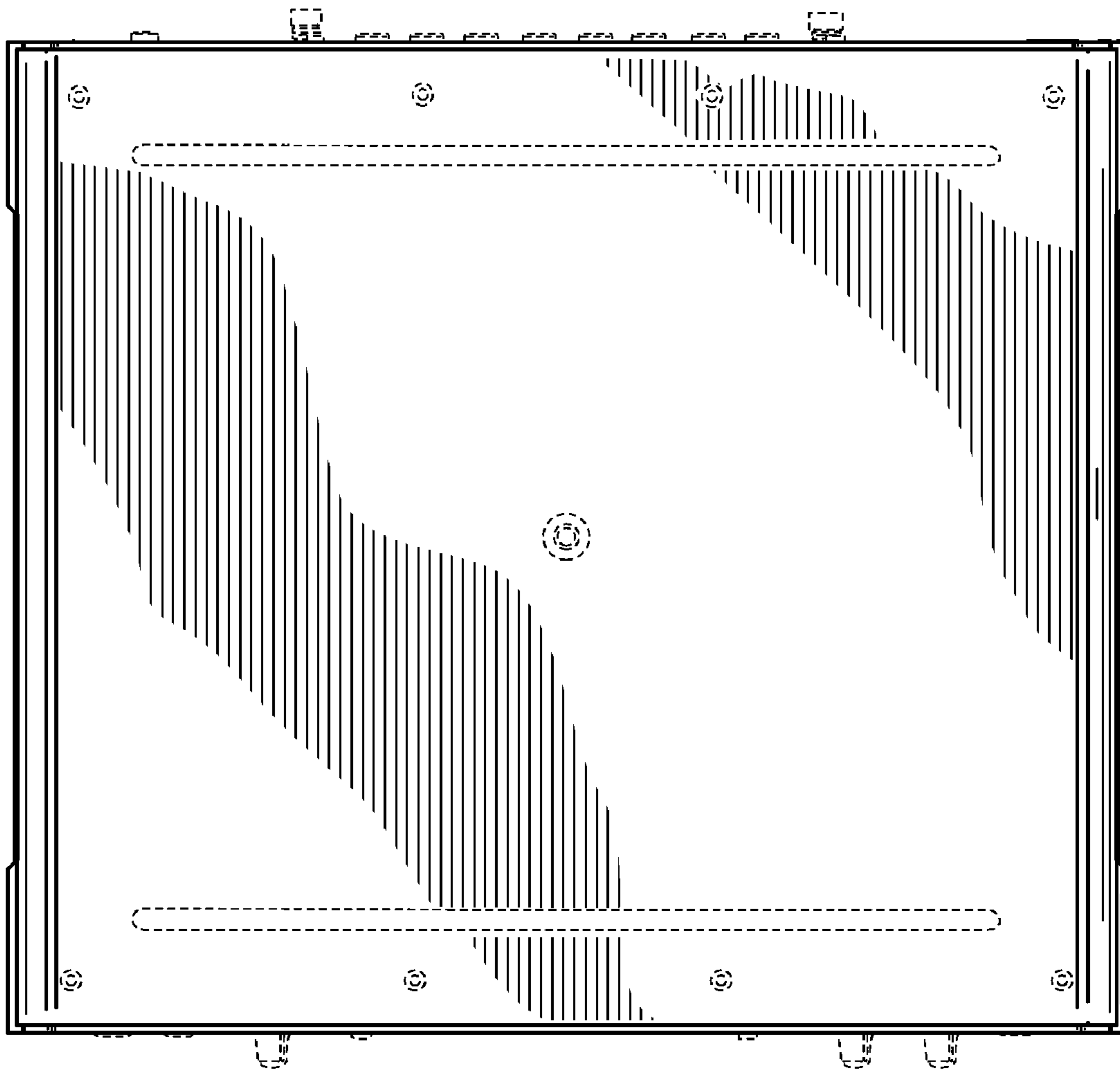

FIG. 5



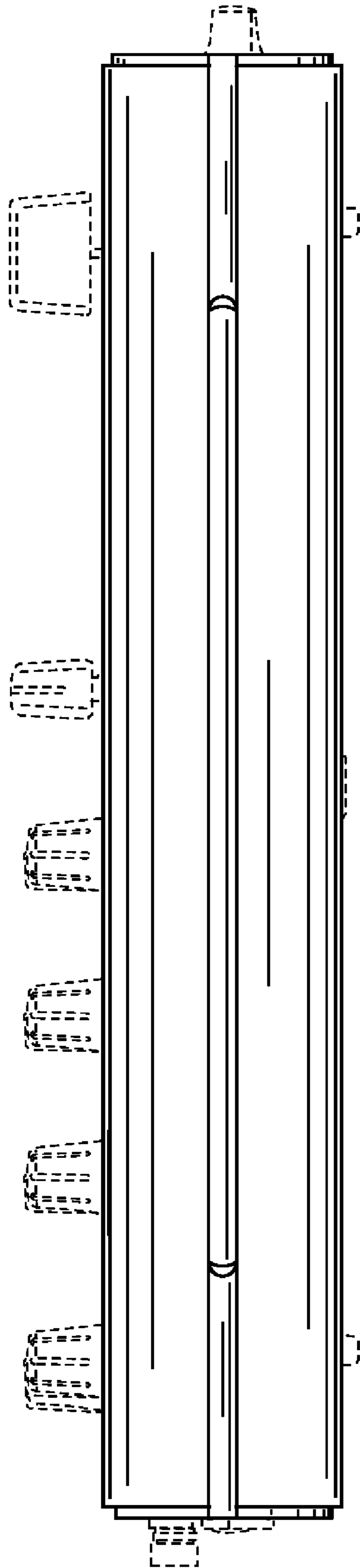

FIG. 6

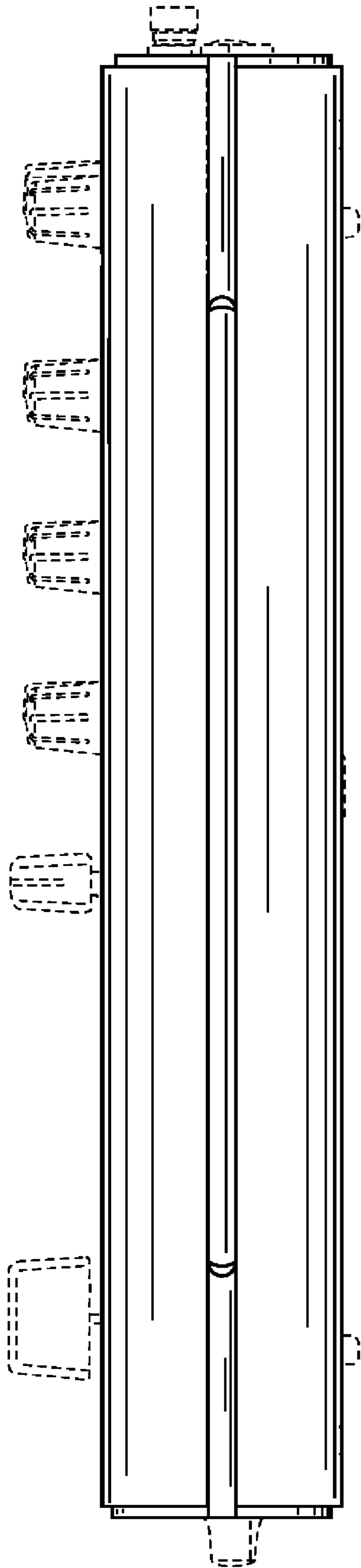

FIG. 7