



US00D555117S

(12) **United States Design Patent**  
**Tanaka et al.**

(10) **Patent No.:** **US D555,117 S**

(45) **Date of Patent:** **\*\* Nov. 13, 2007**

- (54) **TELEVISION RECEIVER**
- (75) Inventors: **Junichi Tanaka**, Tokyo (JP); **Hironori Ohishi**, Tokyo (JP)
- (73) Assignee: **Pioneer Corporation**, Tokyo (JP)
- (\*\*) Term: **14 Years**
- (21) Appl. No.: **29/239,064**
- (22) Filed: **Sep. 27, 2005**

JP	1202074 S	4/2004
JP	1202108 S	4/2004
JP	1203951 S	4/2004
JP	1226033 S	12/2004
JP	1234221 S	3/2005
JP	1234651 S	3/2005
JP	1203214 S	4/2006

- (30) **Foreign Application Priority Data**  
Jun. 21, 2005 (JP) ..... 2005-017899
- (51) **LOC (8) Cl.** ..... **14-03**
- (52) **U.S. Cl.** ..... **D14/126**
- (58) **Field of Classification Search** ..... D14/125-134,  
D14/239, 371, 136, 374-377; 312/7.2; 348/836,  
348/838, 180, 184, 325, 739; 341/12; 248/917-924,  
248/465; 345/104, 133, 156, 168, 87, 173;  
720/605, 669, 600, 655; 369/99, 197; 455/344-347  
See application file for complete search history.

**OTHER PUBLICATIONS**  
Catalogue of Pioneer's television receiver, "Pure Vision", Oct. 2003, Japan, <http://www.pioneer.co.jp/pdp/>.

\* cited by examiner  
*Primary Examiner*—Raphael Barkai  
(74) *Attorney, Agent, or Firm*—Sughrue Mion, PLLC

- (56) **References Cited**  
**U.S. PATENT DOCUMENTS**  
D424,068 S \* 5/2000 Takemasa ..... D14/374  
D502,931 S \* 3/2005 Kita ..... D14/126  
D505,403 S \* 5/2005 Kita ..... D14/134  
D533,149 S \* 12/2006 Inoue ..... D14/126  
D534,878 S \* 1/2007 Ellison ..... D14/126  
D540,284 S \* 4/2007 Kita ..... D14/126

(57) **CLAIM**  
The ornamental design for a television receiver, as shown and described.

- FOREIGN PATENT DOCUMENTS**  
JP 1123863 S 10/2001  
JP 1157263 S 11/2002

**DESCRIPTION**  
FIG. 1 is a front view of a television receiver showing our new design;  
FIG. 2 is a rear view thereof;  
FIG. 3 is a top plan view thereof;  
FIG. 4 is a bottom view thereof;  
FIG. 5 is a right side view, a left side view being a mirror image thereof;  
FIG. 6 is a perspective view thereof;  
FIG. 7 is an enlarged view of A—A mentioned in FIG. 1 thereof; and,  
FIG. 8 is an enlarged view of B—B mentioned in FIG. 3 thereof.

**1 Claim, 4 Drawing Sheets**

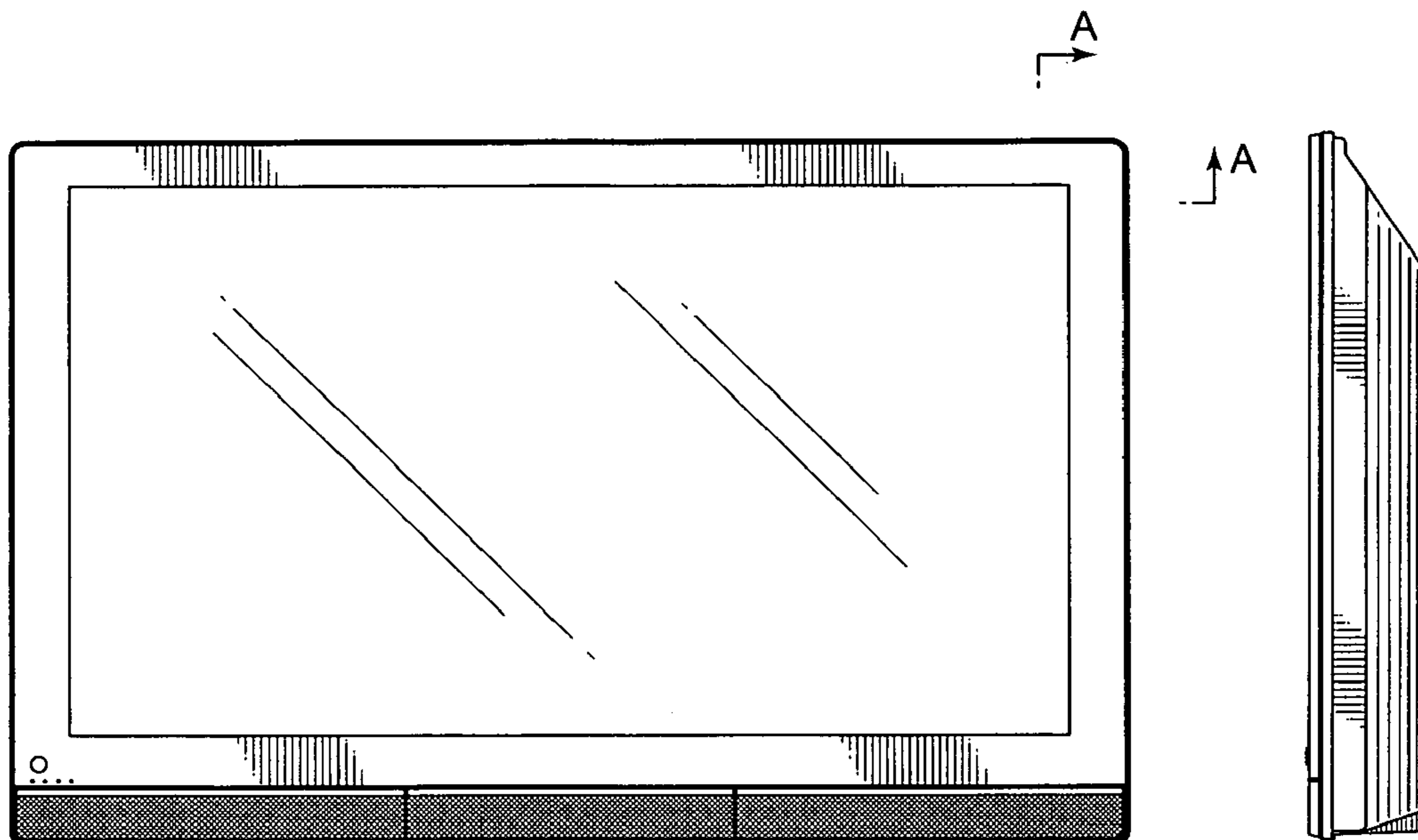

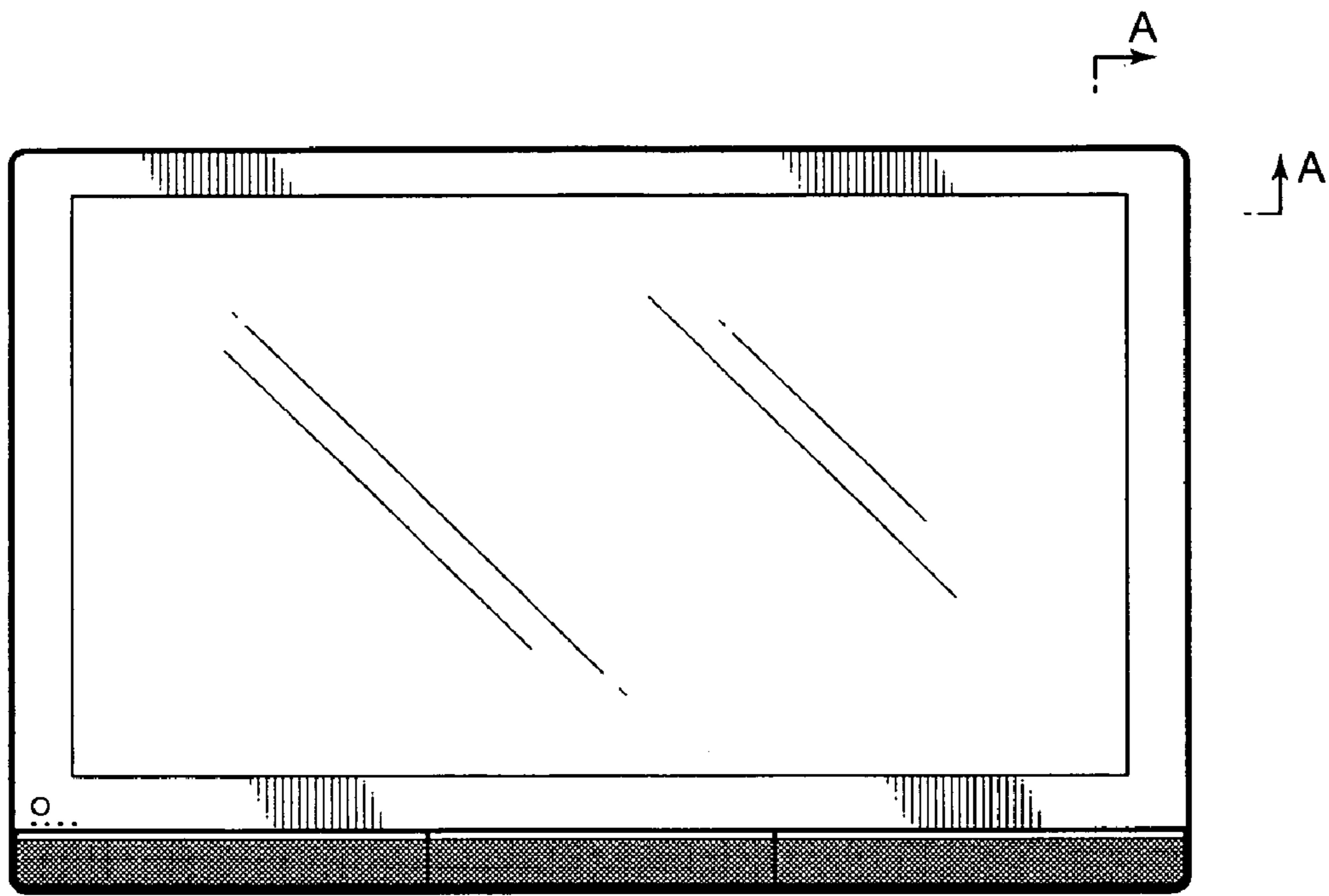

FIG. 1

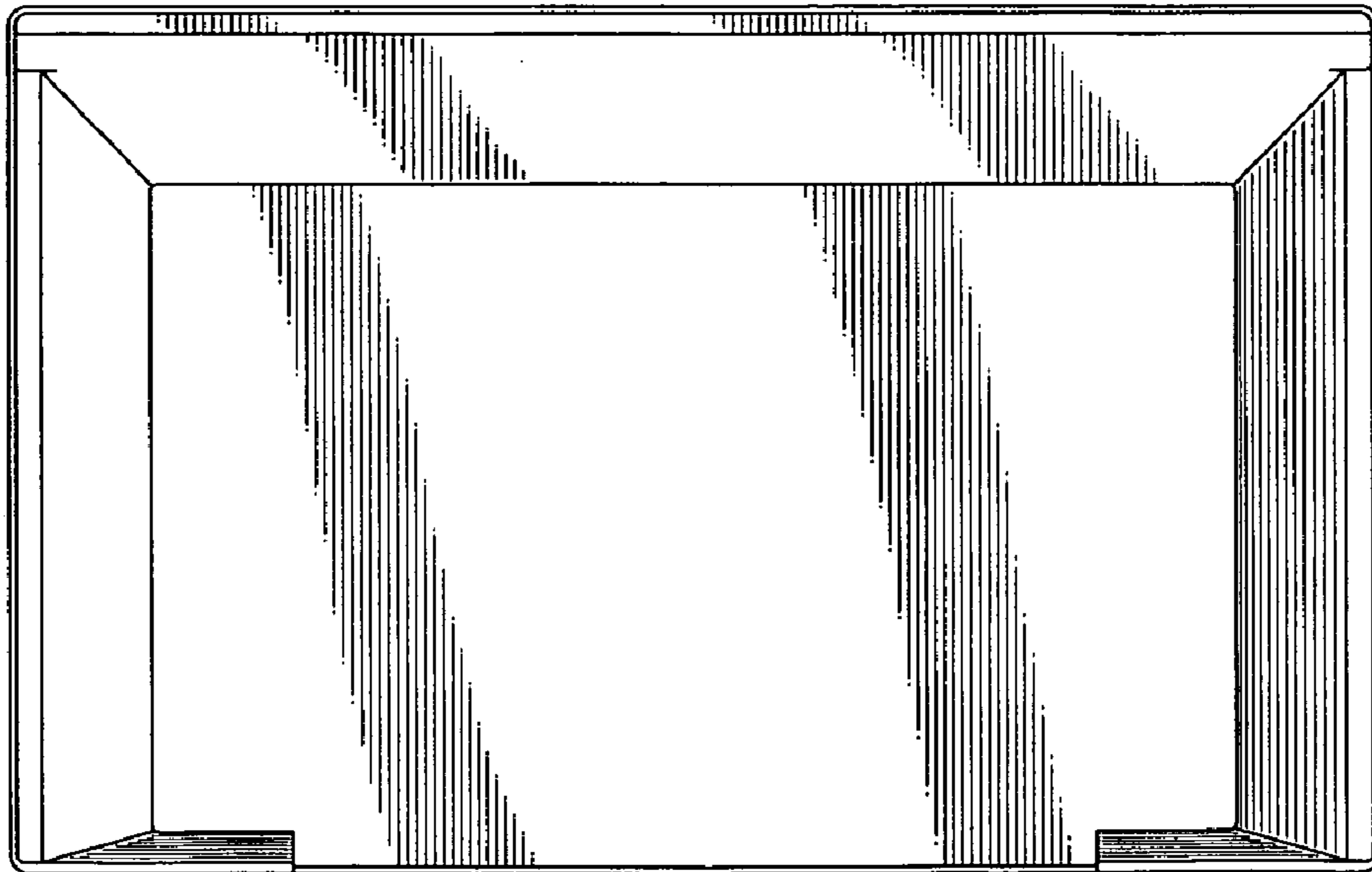
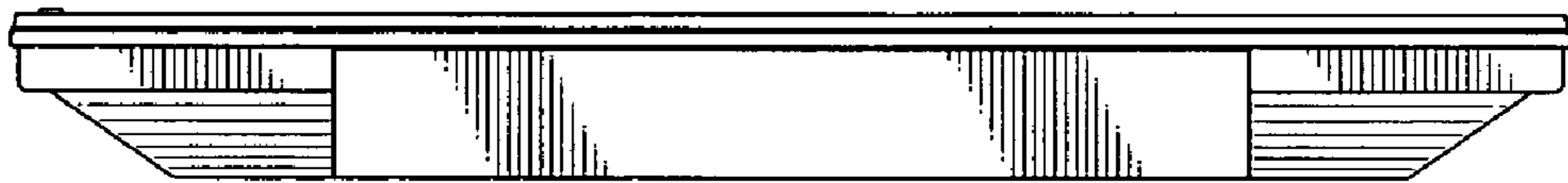
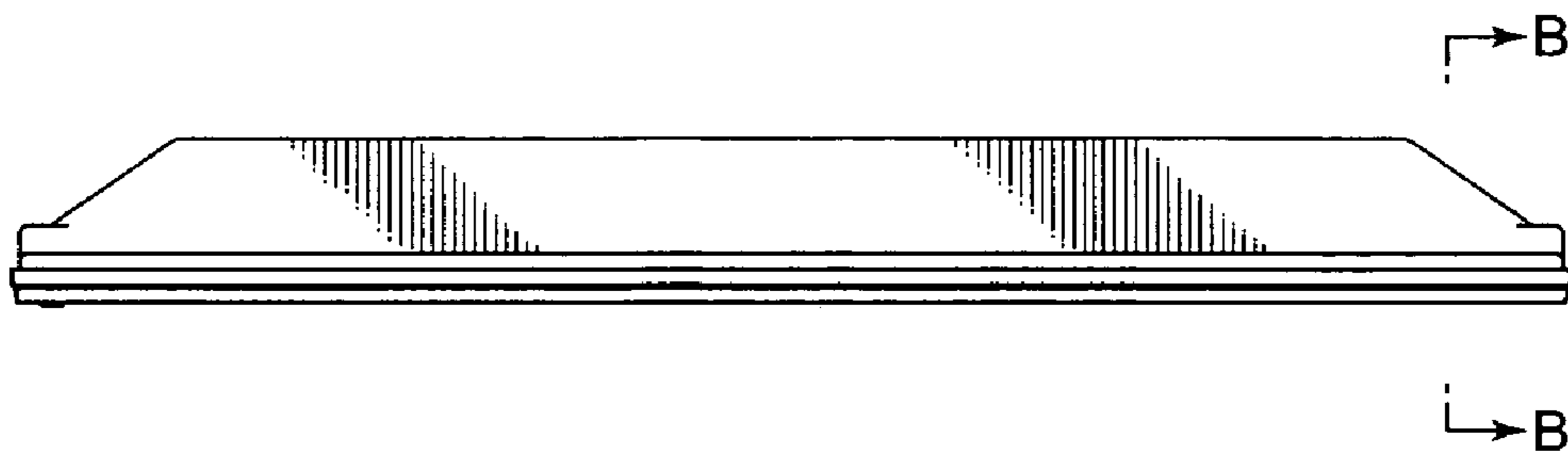

FIG. 2



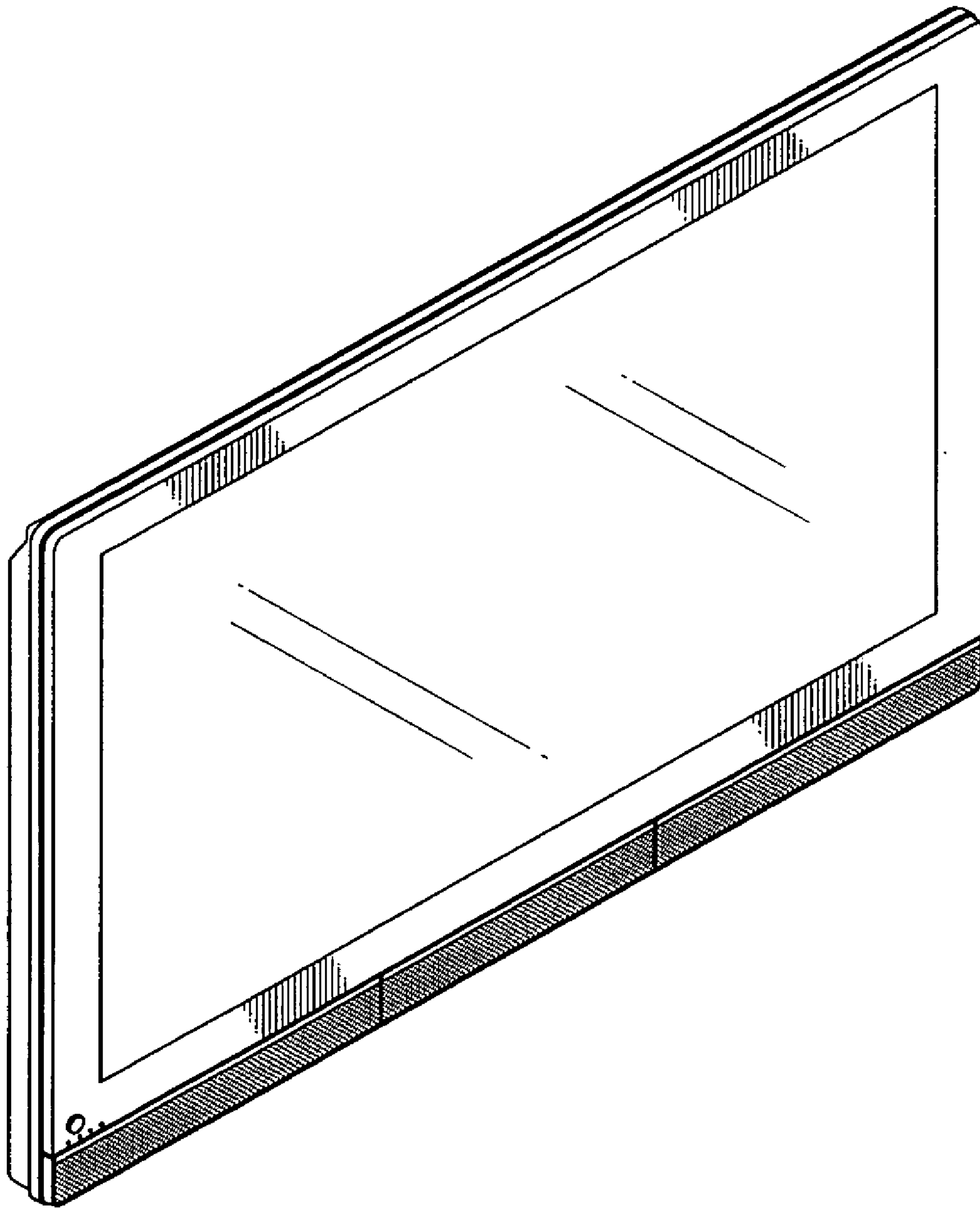

FIG. 6

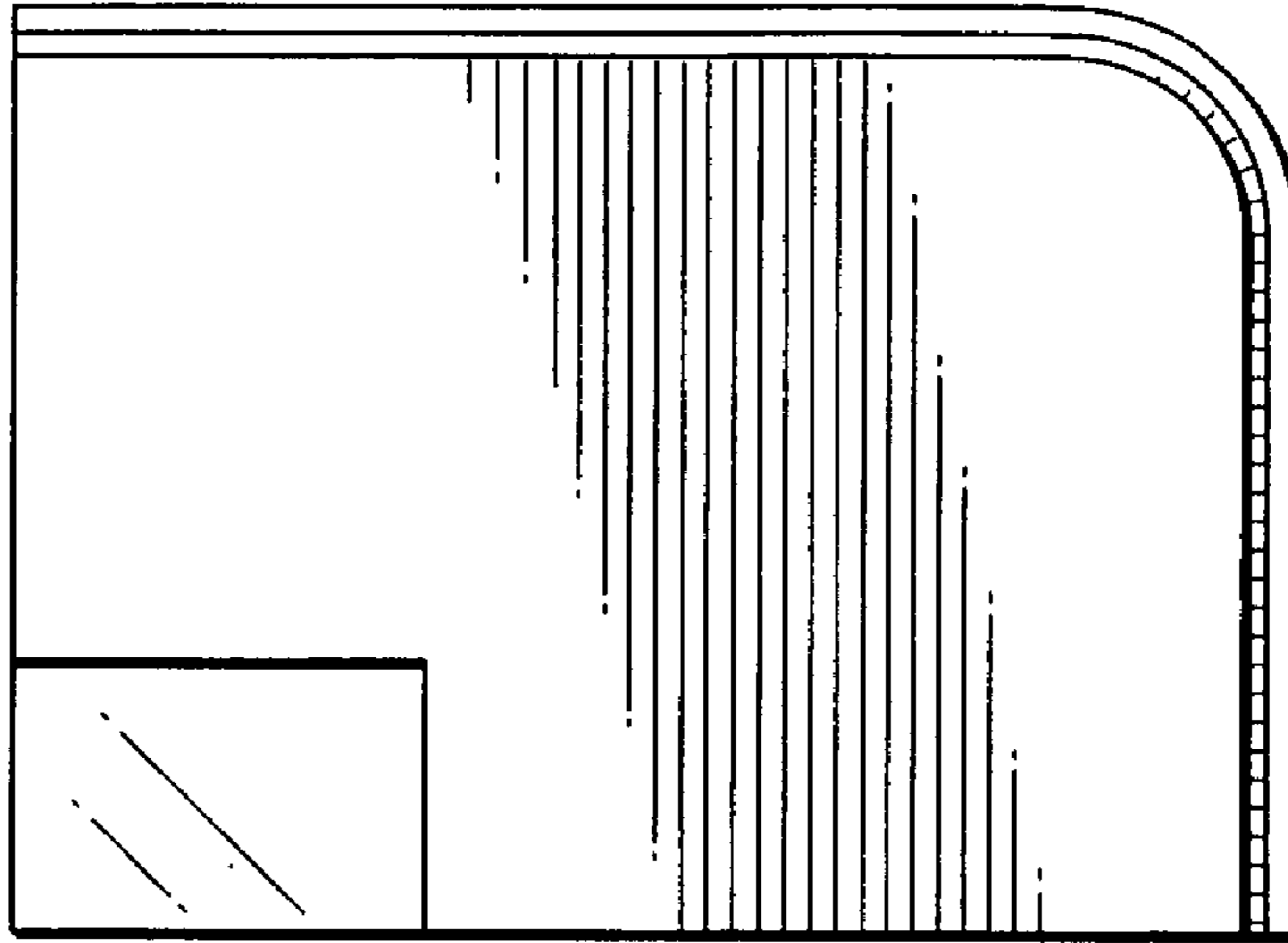

FIG. 7

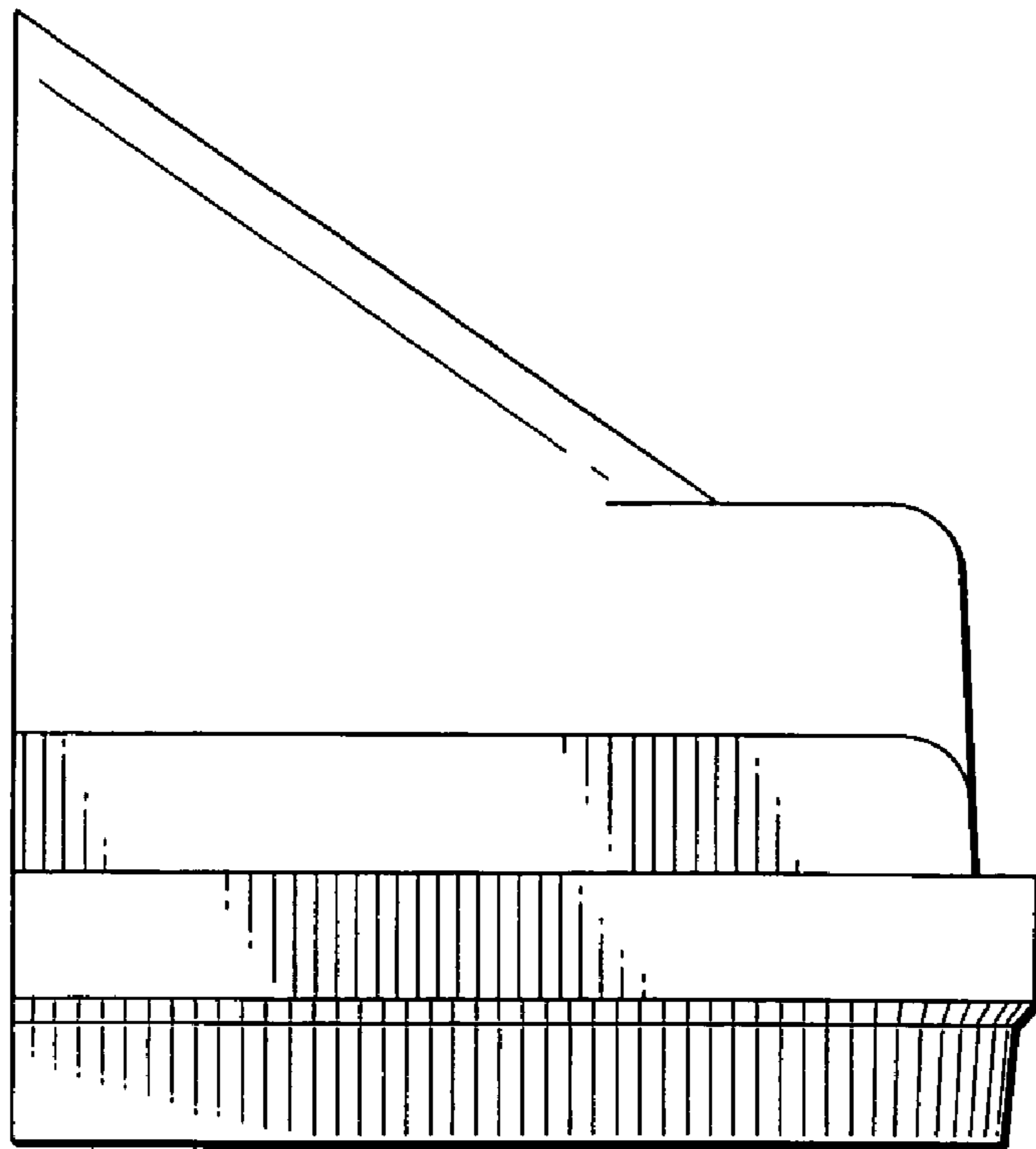

FIG. 8