



US00D555008S

(12) **United States Design Patent**
Gattino

(10) **Patent No.:** **US D555,008 S**

(45) **Date of Patent:** **** Nov. 13, 2007**

(54) **BAG FOR CARRYING, DISPLAYING, AND SERVING BEVERAGES**

(75) Inventor: **Samy Gattino**, Cedex (FR)

(73) Assignee: **GIMEX International S.A.**, Cedex (FR)

(**) Term: **14 Years**

(21) Appl. No.: **29/268,208**

(22) Filed: **Oct. 31, 2006**

(30) **Foreign Application Priority Data**

Sep. 8, 2006 (FR) 06/4097

(51) **LOC (8) Cl.** **09-01**

(52) **U.S. Cl.** **D9/702**

(58) **Field of Classification Search** D9/702,
D9/414, 703-710; D3/303; 40/638; 383/6,
383/40, 20, 84, 89, 91, 211

See application file for complete search history.

(56) **References Cited**

U.S. PATENT DOCUMENTS

6,299,352	B1 *	10/2001	Julien	383/40
D461,956	S *	8/2002	Andrew	D3/303
D485,166	S *	1/2004	Clark	D9/704
6,749,064	B1 *	6/2004	Alrey	206/457
D494,853	S *	8/2004	Chan	D9/704

* cited by examiner

Primary Examiner—Stella Reid
Assistant Examiner—Rashida C. McCoy
(74) *Attorney, Agent, or Firm*—Abelman, Frayne & Schwab

(57) **CLAIM**

The ornamental design for bag for carrying, displaying, and serving beverages, as shown and described.

DESCRIPTION

FIG. 1 is a right, front, perspective view of a bag for carrying, displaying, and serving beverages showing my new design;

FIG. 2 is a top view thereof;

FIG. 3 is a front view thereof;

FIG. 4 is a bottom view thereof;

FIG. 5 is a left side view thereof, with the right side view being a mirror image thereof; and,

FIG. 6 is a rear view thereof; and,

FIG. 7 is a front, right, perspective view of an alternative embodiment of a bag for carrying, displaying, and serving beverages with the only difference being the omission of the label and the indicia on the surface of the bag.

The broken line showing of the bottle is included for the purpose of illustrating use and forms no part of the claimed design.

1 Claim, 4 Drawing Sheets

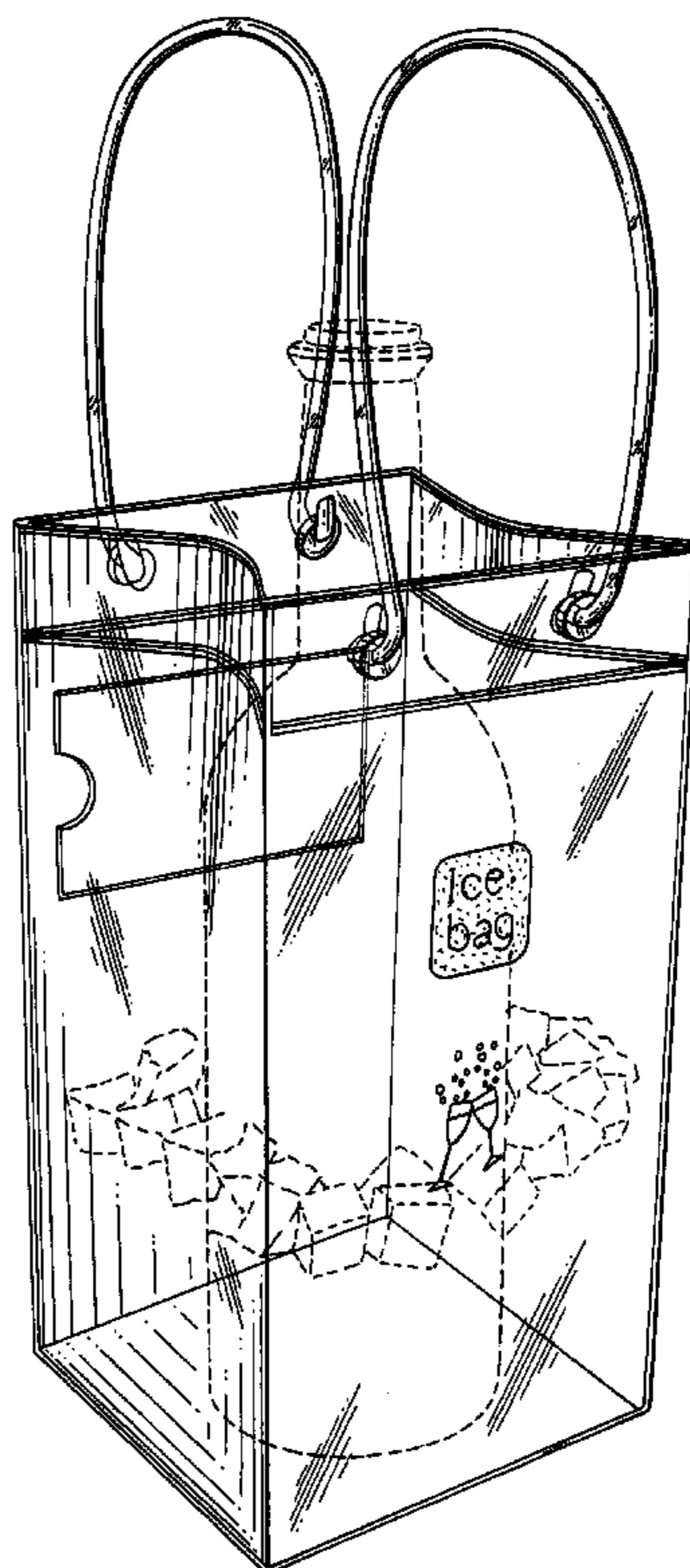

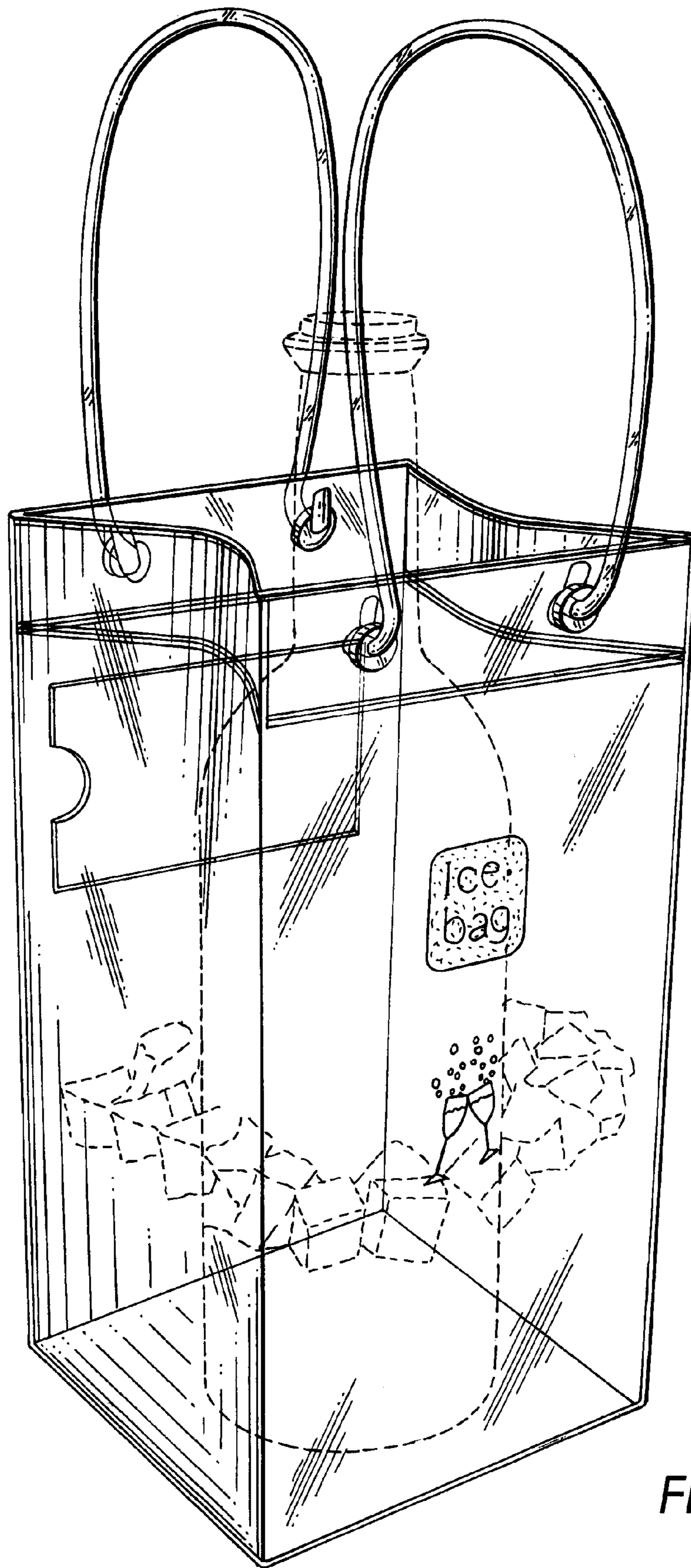

FIG. 1

FIG. 2

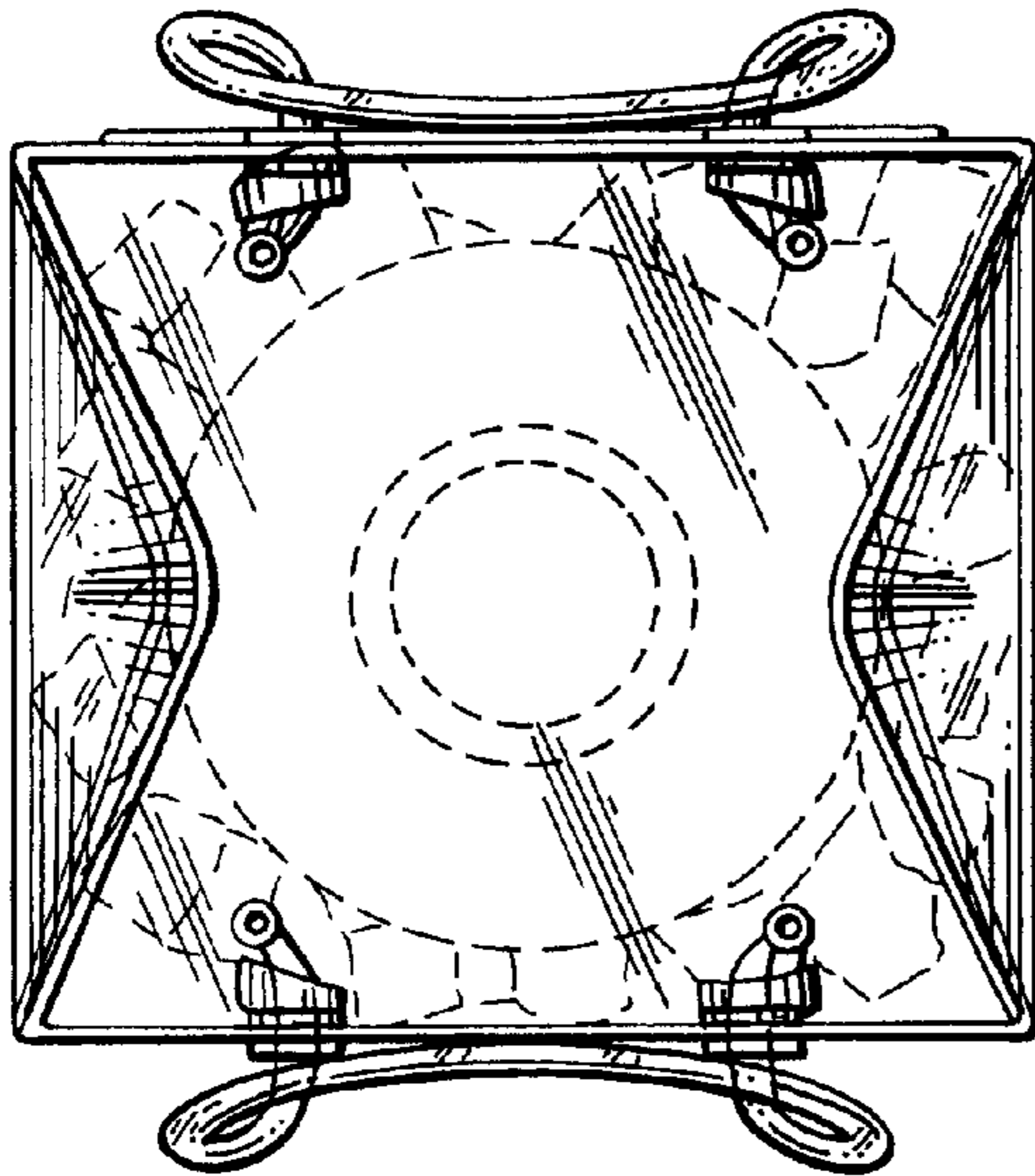

FIG. 3

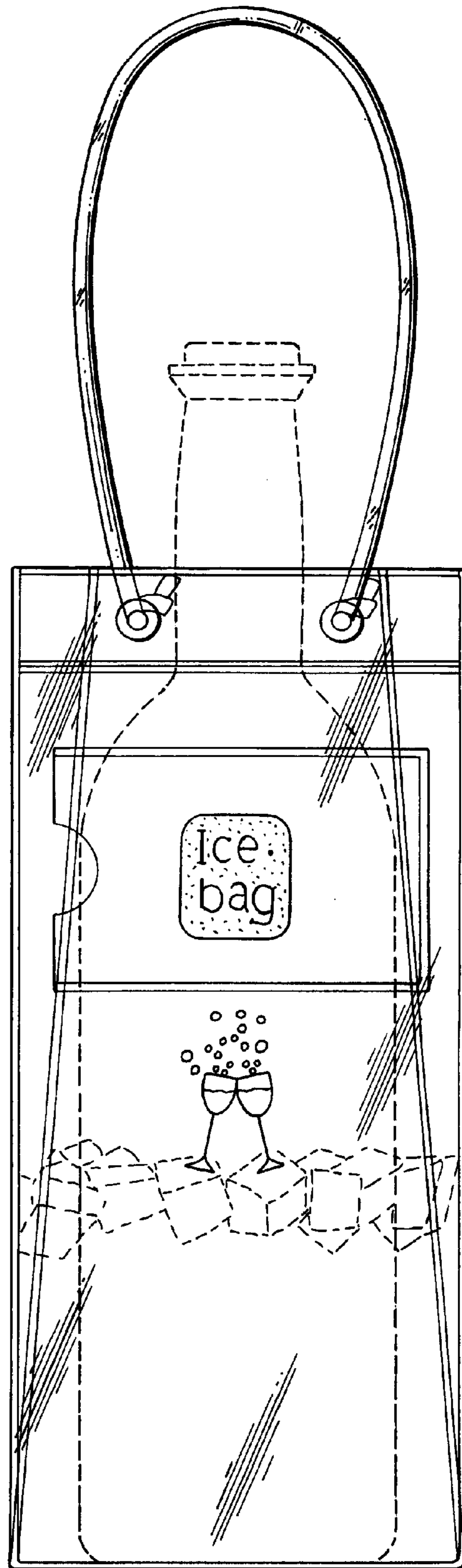
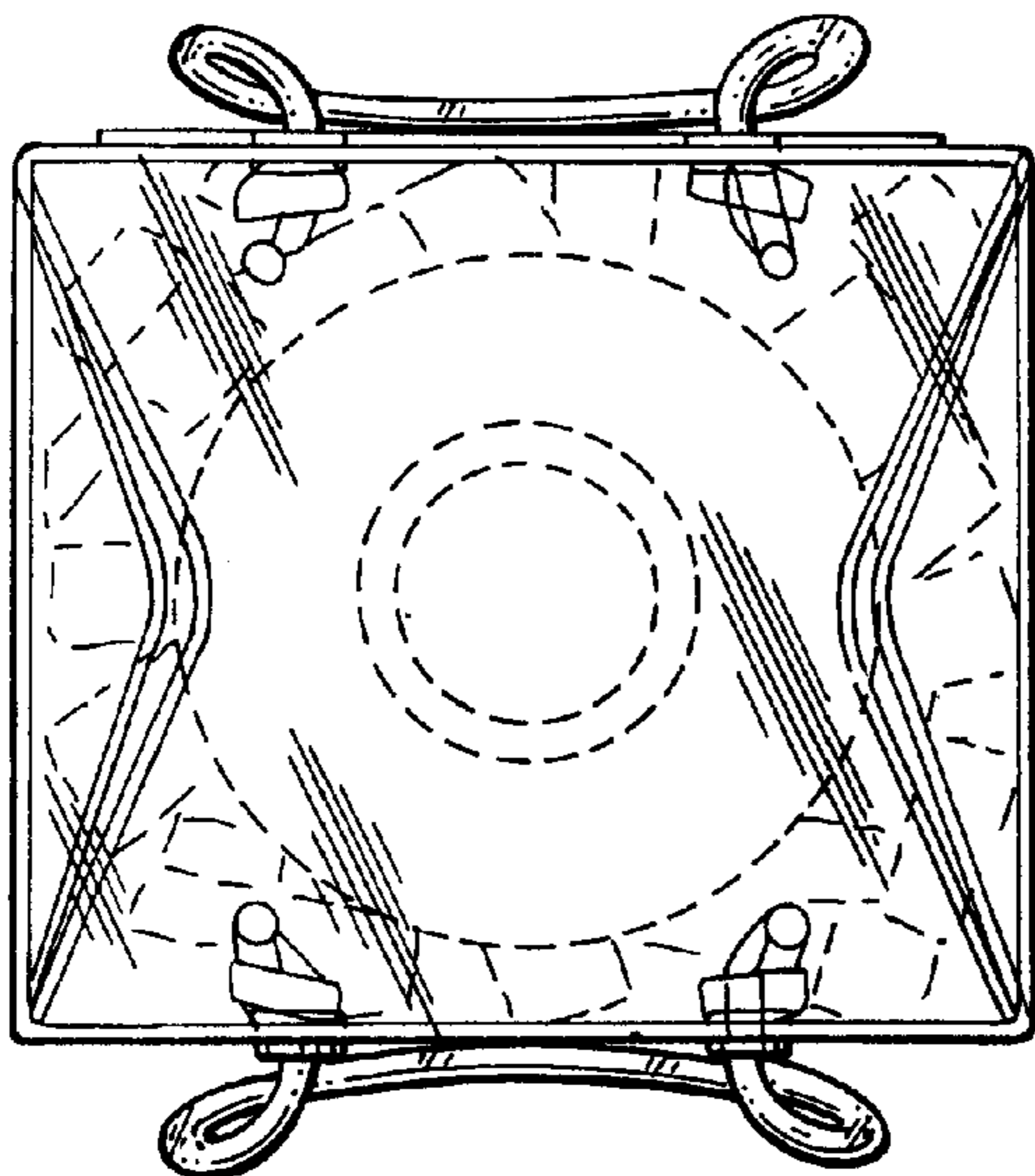
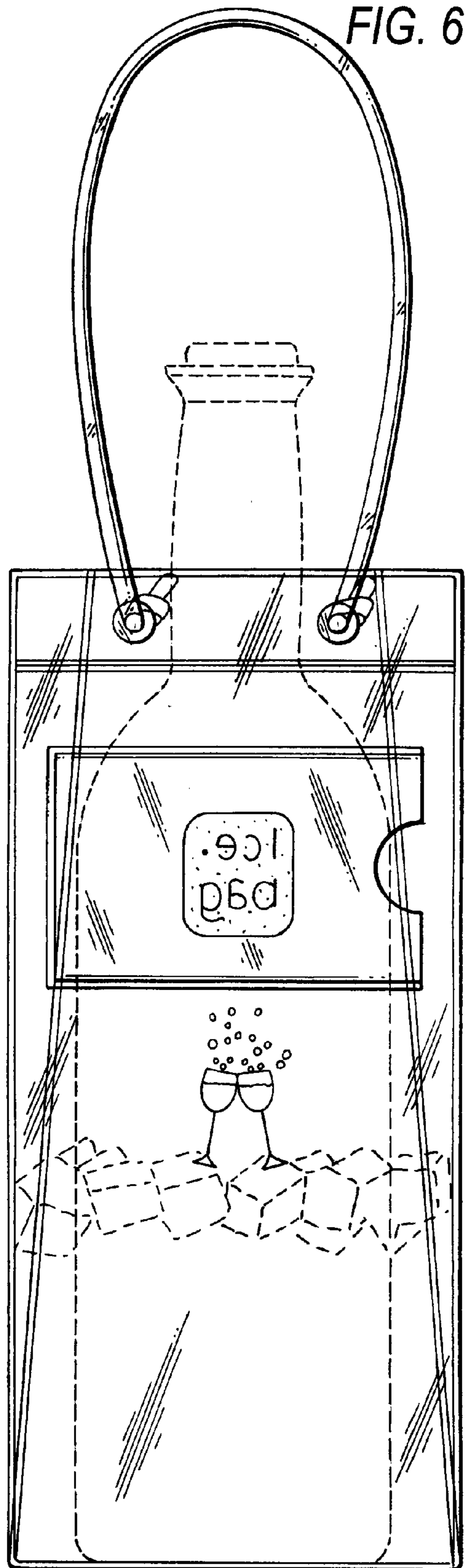
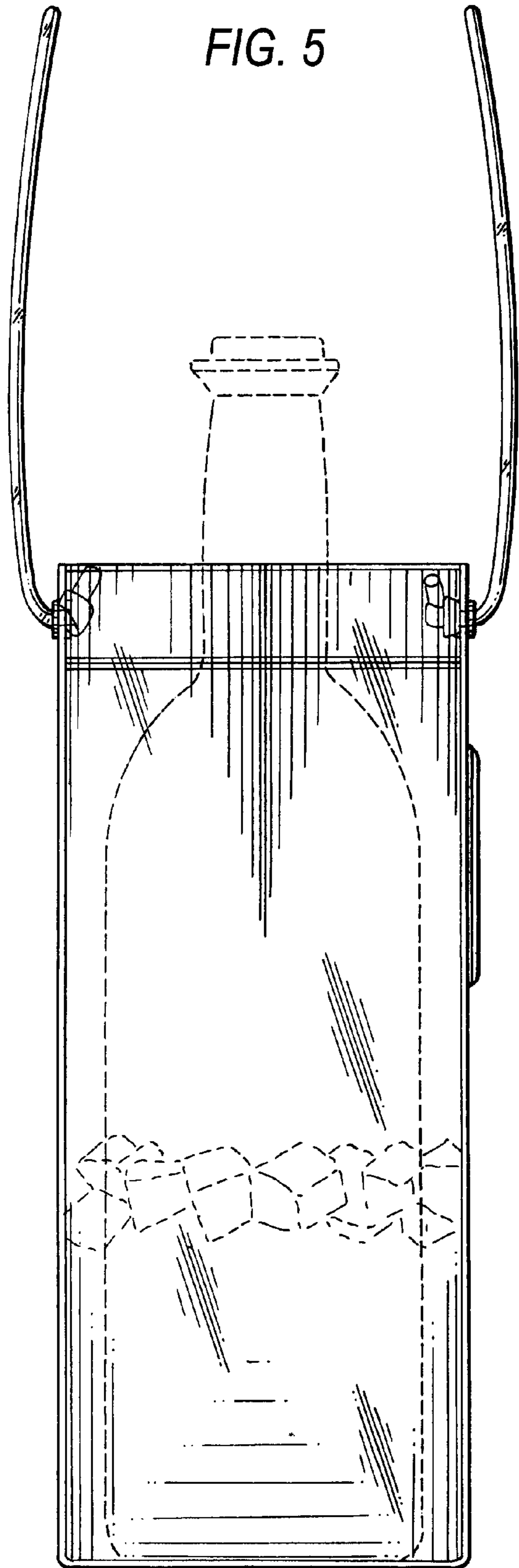

FIG. 4





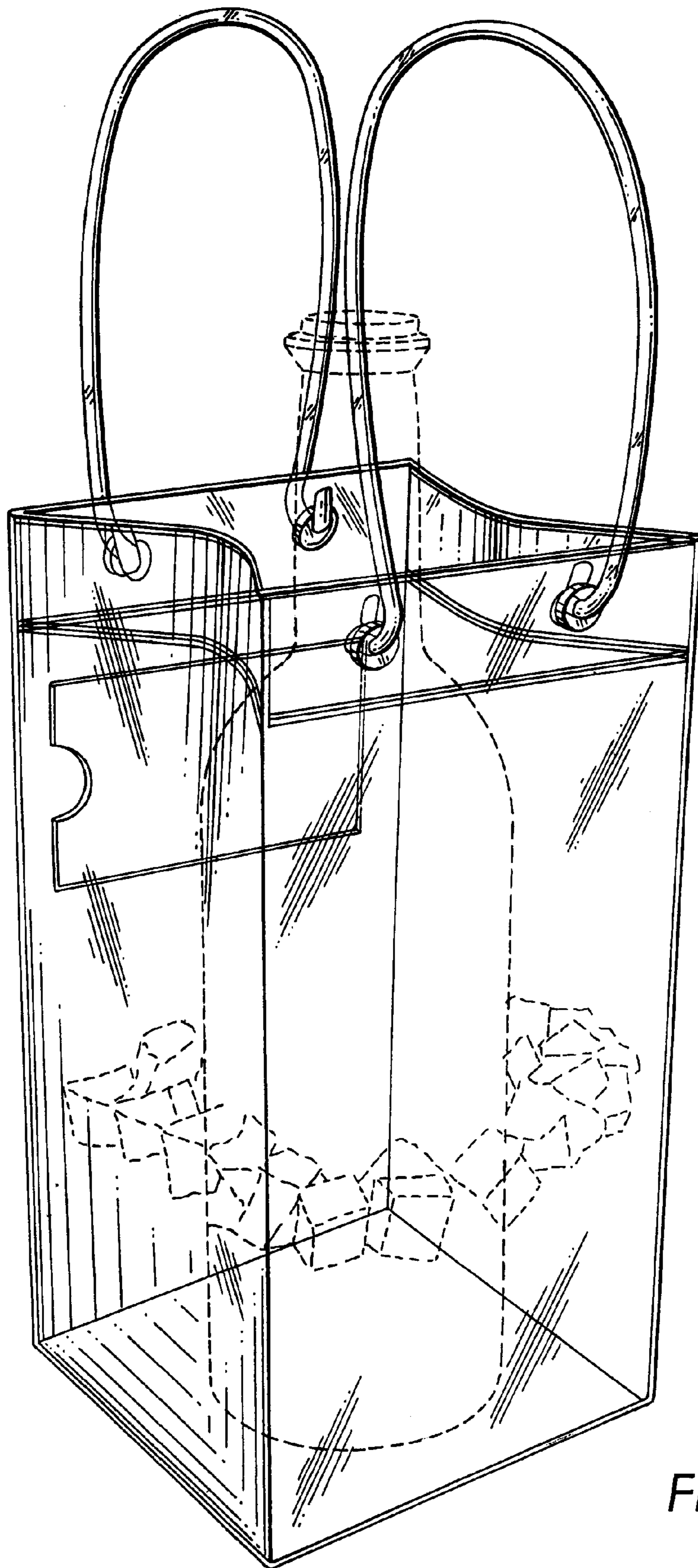

FIG. 7