



US00D554991S

(12) **United States Design Patent**
Donnelly

(10) **Patent No.:** **US D554,991 S**

(45) **Date of Patent:** **** Nov. 13, 2007**

(54) **DISPOSABLE FOOD CONTAINER**

(74) *Attorney, Agent, or Firm*—DLA Piper US LLP

(75) Inventor: **Brian Donnelly**, Winnipeg (CA)

(57) **CLAIM**

(73) Assignee: **3641082 Maintoba Inc.**, Winnipeg, Manitoba

The ornamental design for a disposable food container, as shown and described.

(**) Term: **14 Years**

DESCRIPTION

(21) Appl. No.: **29/276,767**

FIG. 1 is a top perspective view of a disposable food container according to the invention;

(22) Filed: **Feb. 5, 2007**

FIG. 2 is a front elevational view of a disposable food container according to the invention;

(51) **LOC (8) Cl.** **09-03**

FIG. 3 is a rear elevational view of a disposable food container according to the invention;

(52) **U.S. Cl.** **D9/432**

FIG. 4 is a left side elevational view of a disposable food container according to the invention;

(58) **Field of Classification Search** D9/430-433,
D9/414-418, 761; 229/105-106, 108, 108.1,
229/100, 112-113, 115-116, 162.1, 922,
229/938; 206/551, 746, 457, 784, 822
See application file for complete search history.

FIG. 5 is a right side elevational view of a disposable food container according to the invention;

(56) **References Cited**

FIG. 6 is a top plan view of a disposable food container according to the invention;

U.S. PATENT DOCUMENTS

FIG. 7 is bottom plan view of a disposable food container according to the invention; and,

1,707,528 A * 4/1929 La Bombard et al. .. 229/117.26

FIG. 8 is a perspective view of a disposable food container in a open position according to the invention, with the handle omitted to provide a clearer view.

4,763,833 A * 8/1988 Stoll 229/117.12

5,878,946 A * 3/1999 Frerot et al. 229/117.13

D495,950 S * 9/2004 Cotert et al. D9/416

* cited by examiner

Primary Examiner—Robert A. Delehanty

1 Claim, 8 Drawing Sheets

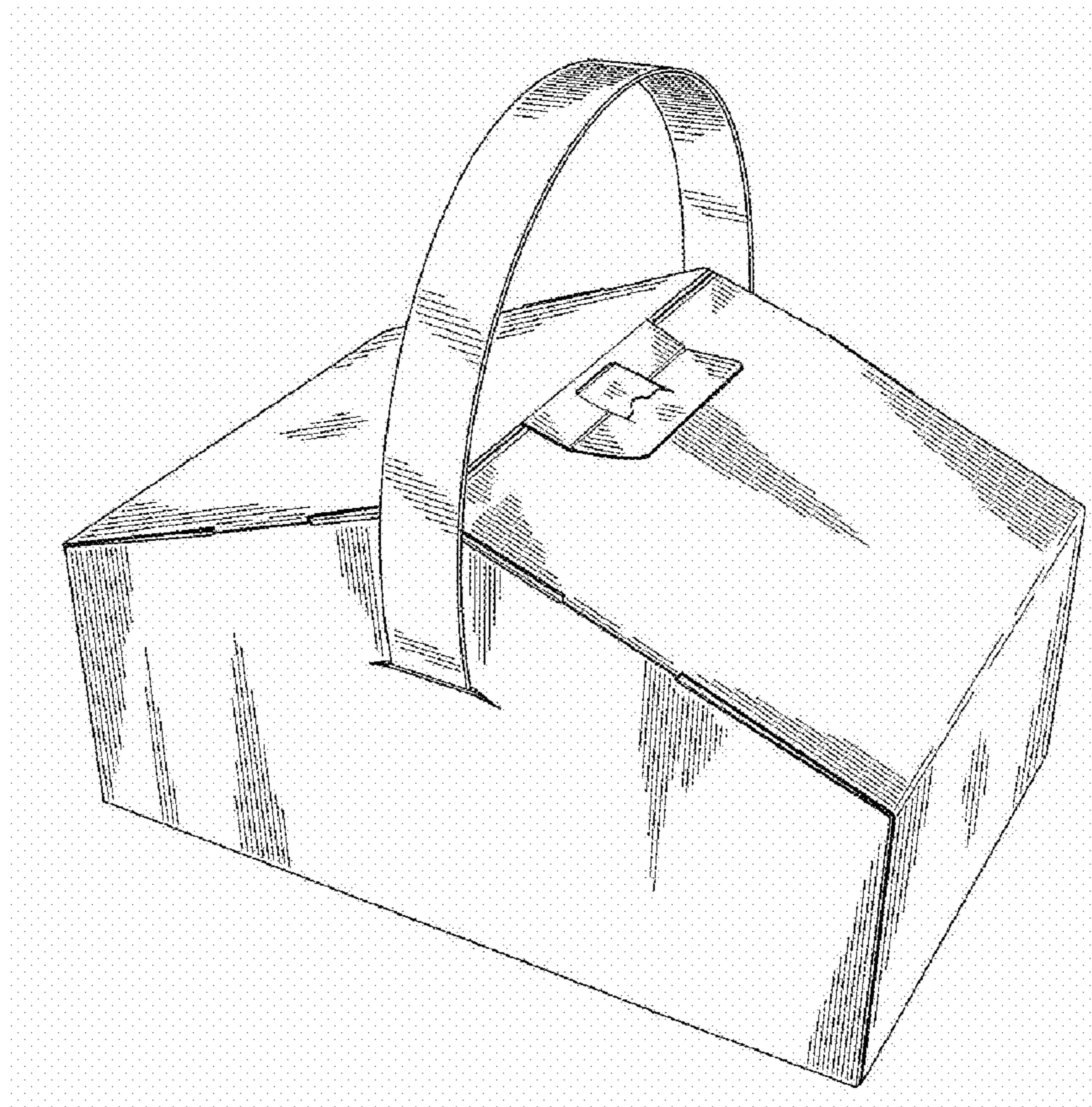

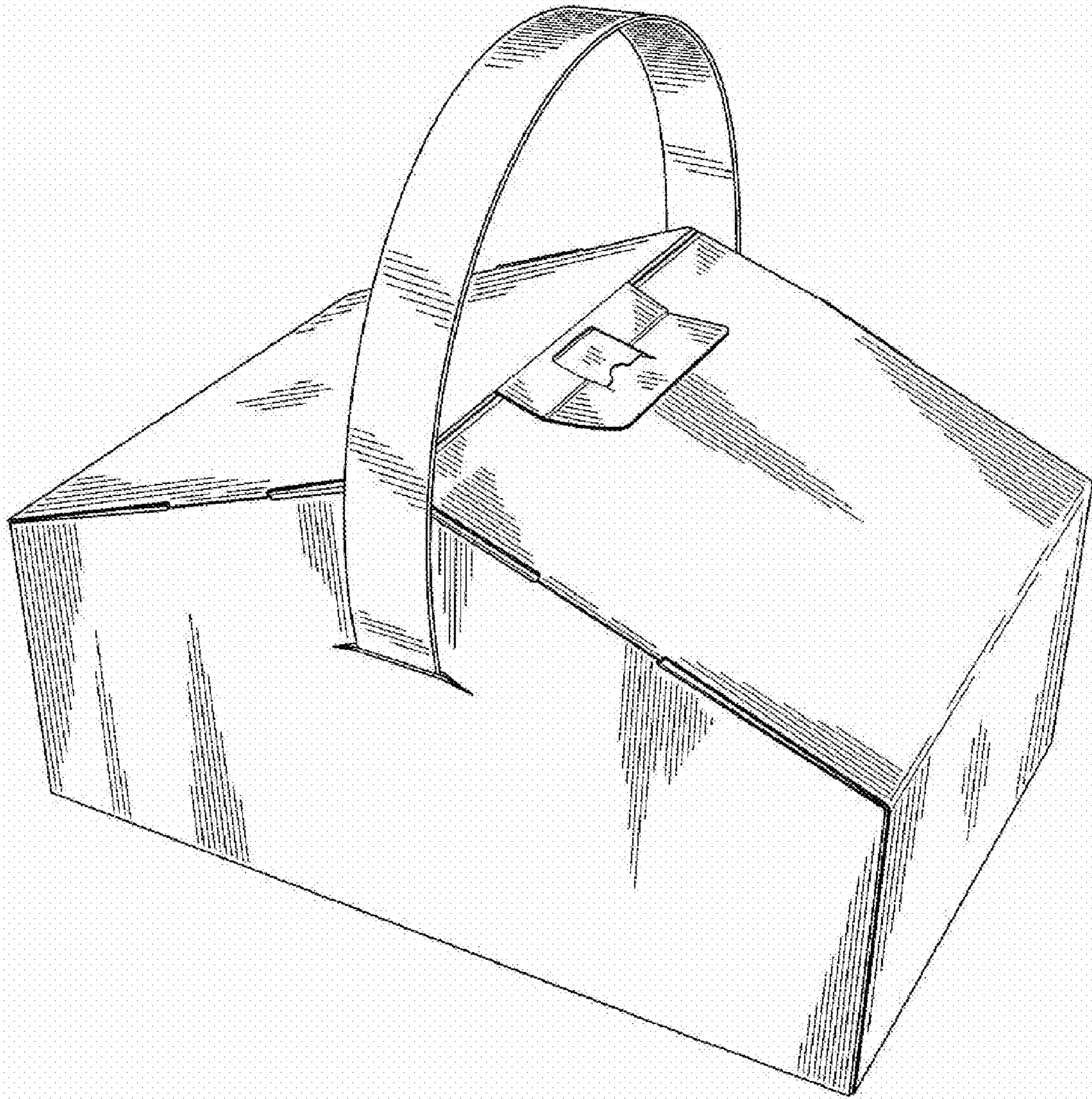

FIG. 1

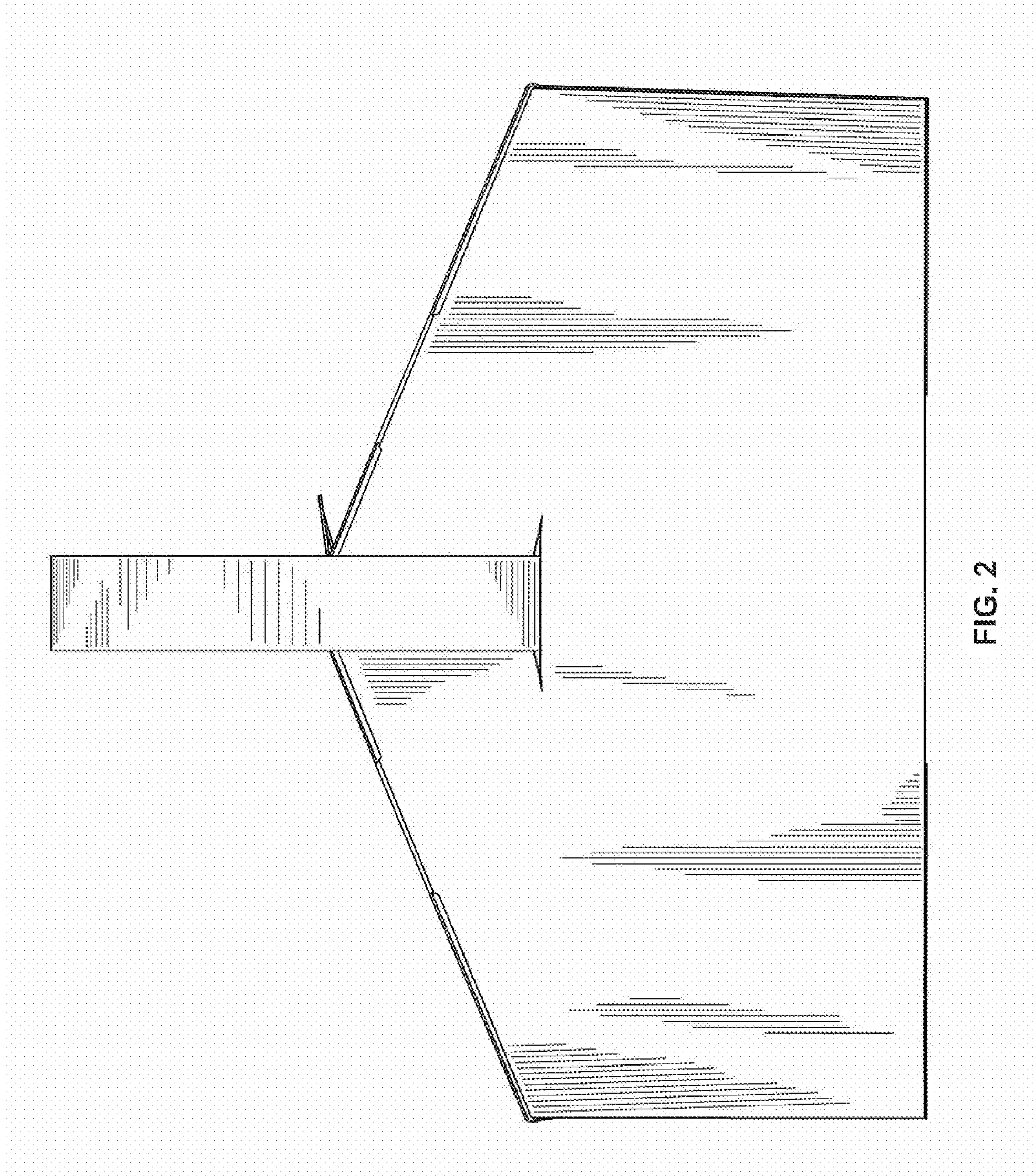

FIG. 2

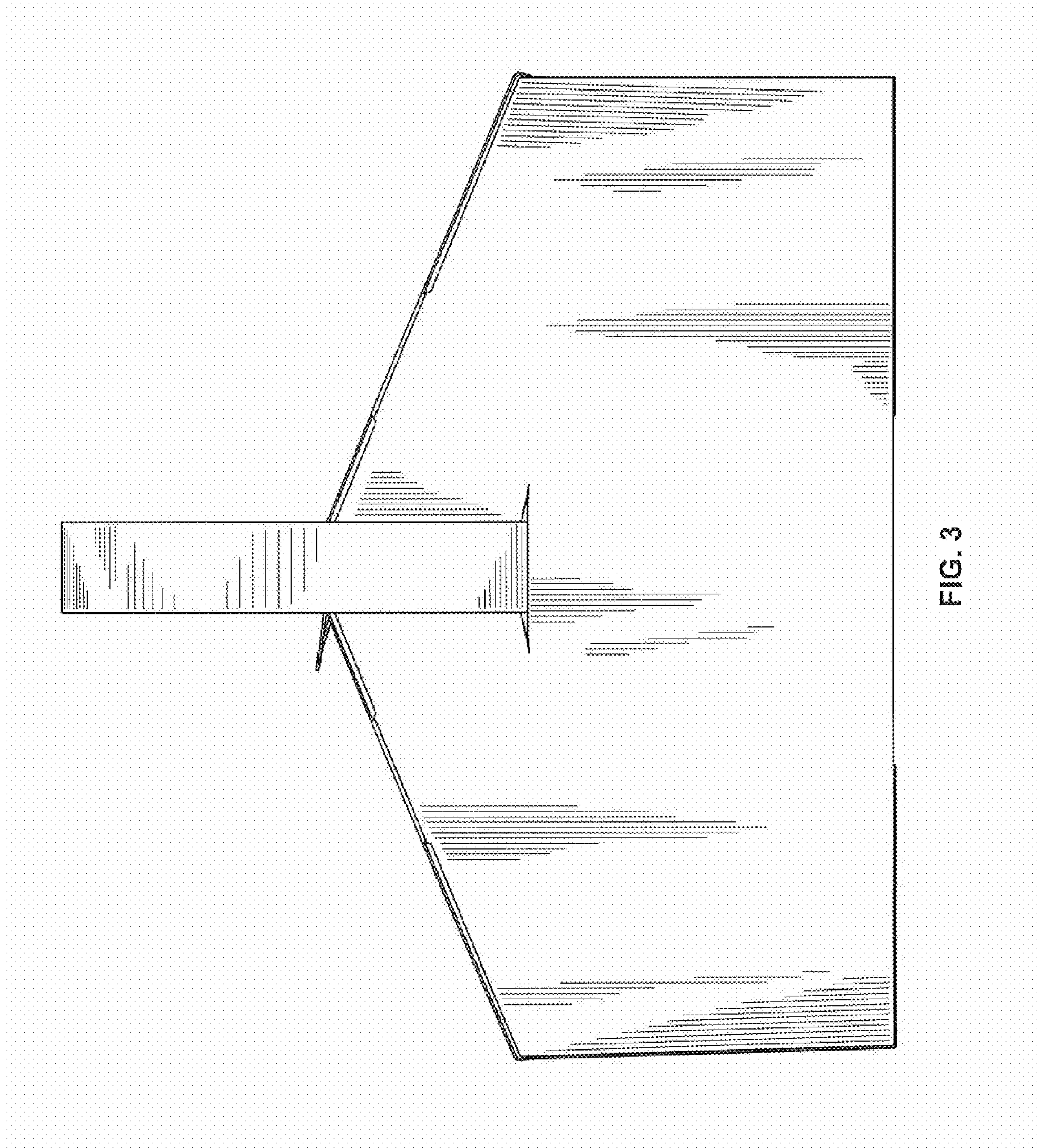

FIG. 3

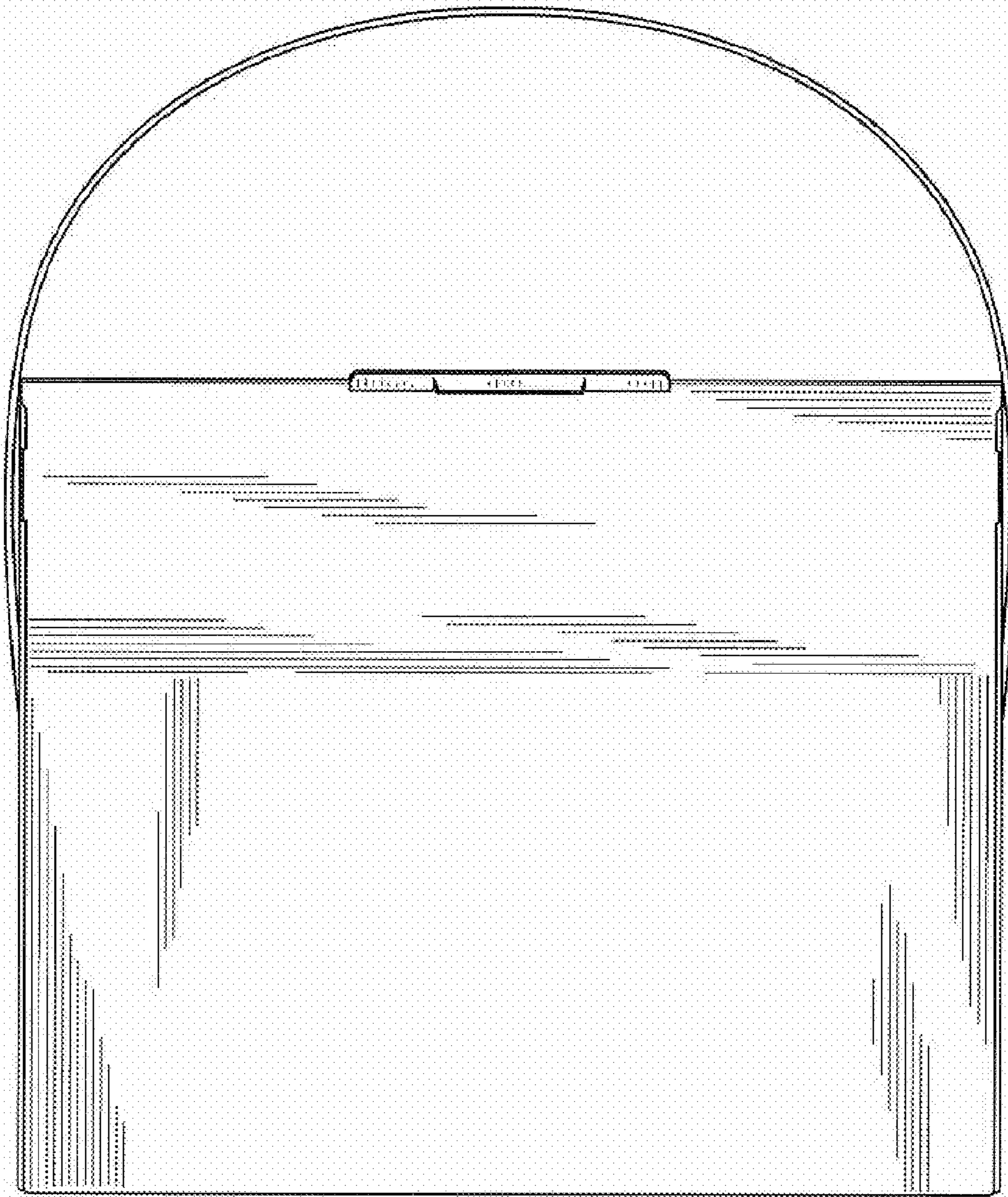

FIG. 4

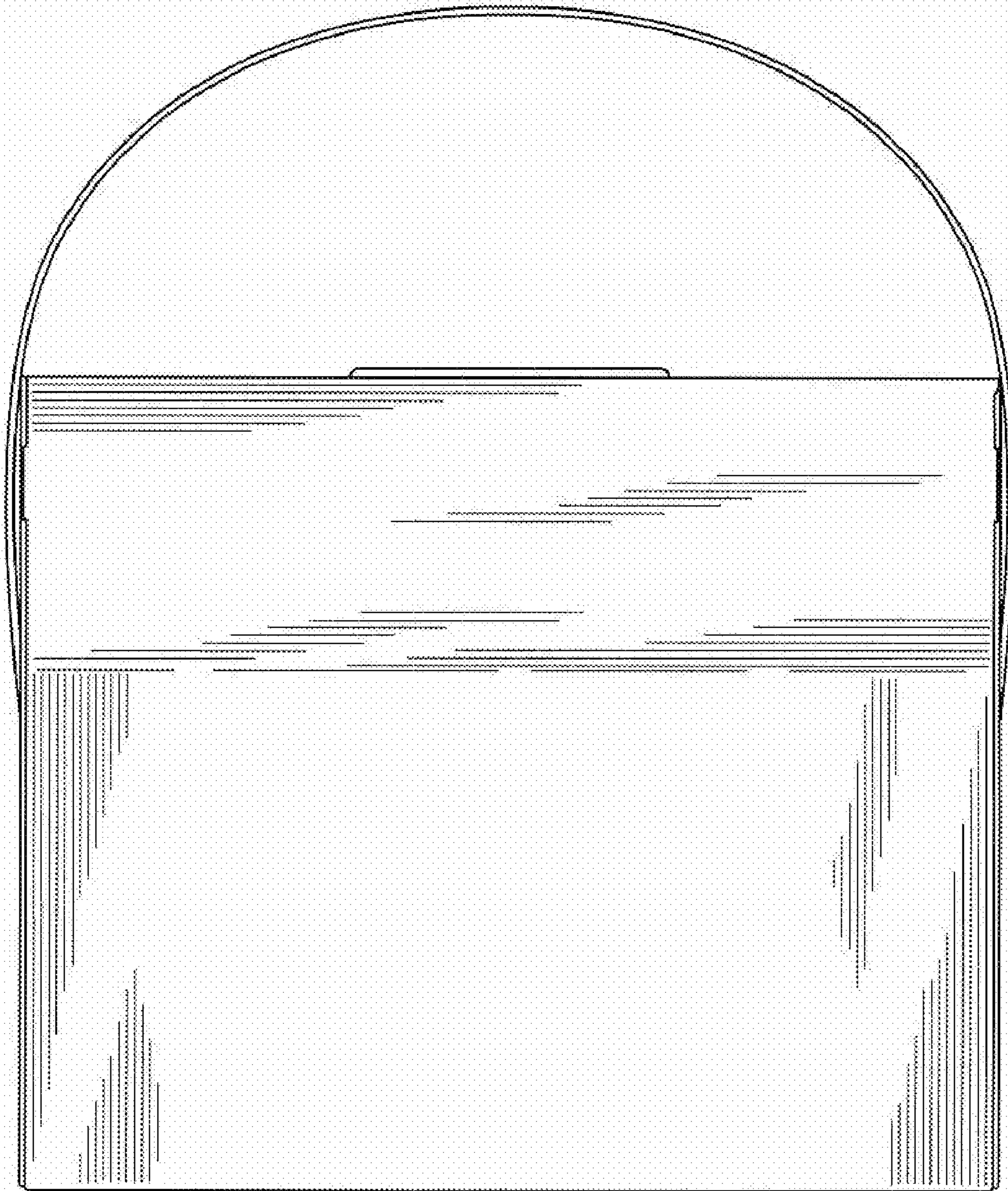

FIG. 5

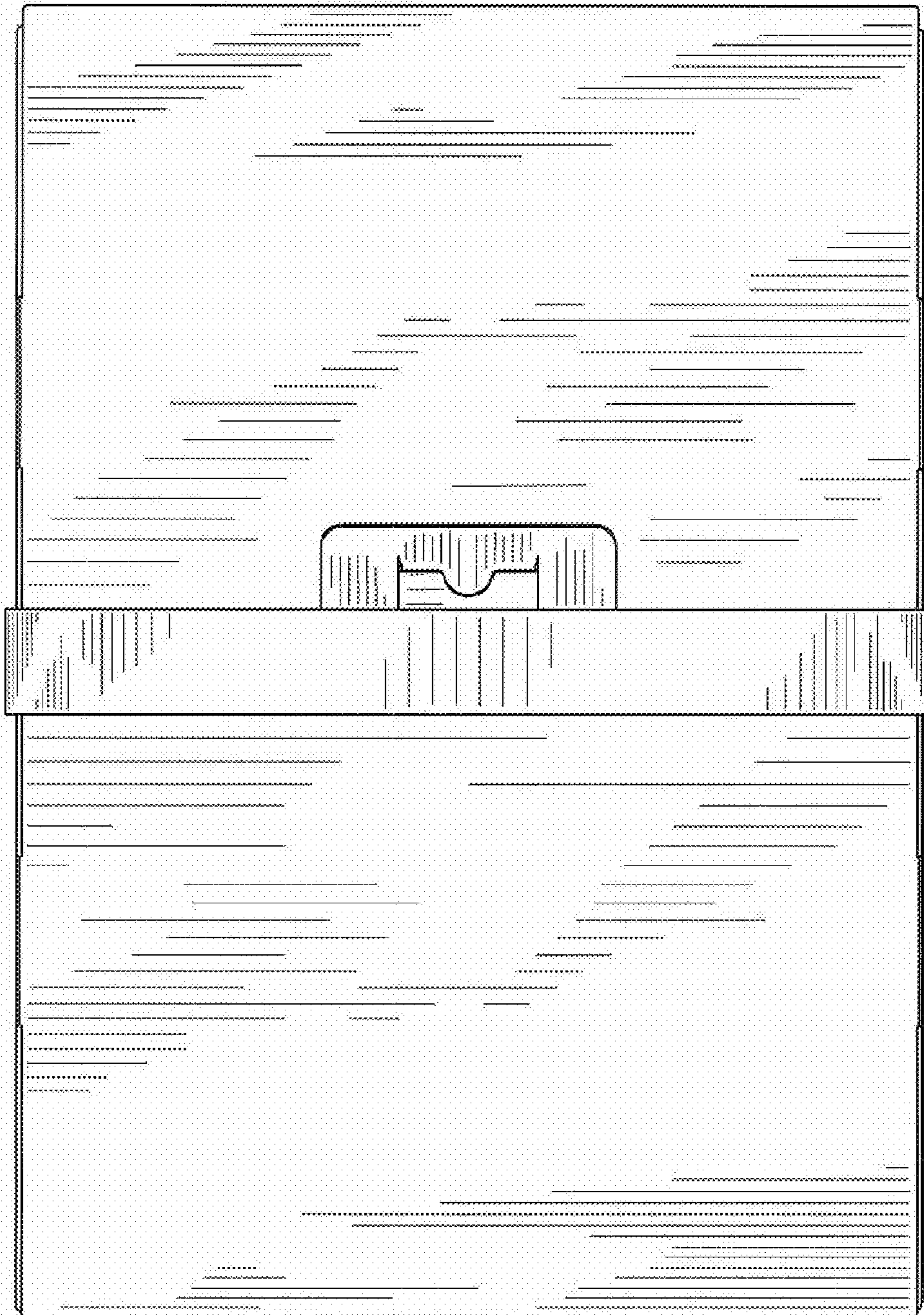

FIG. 6

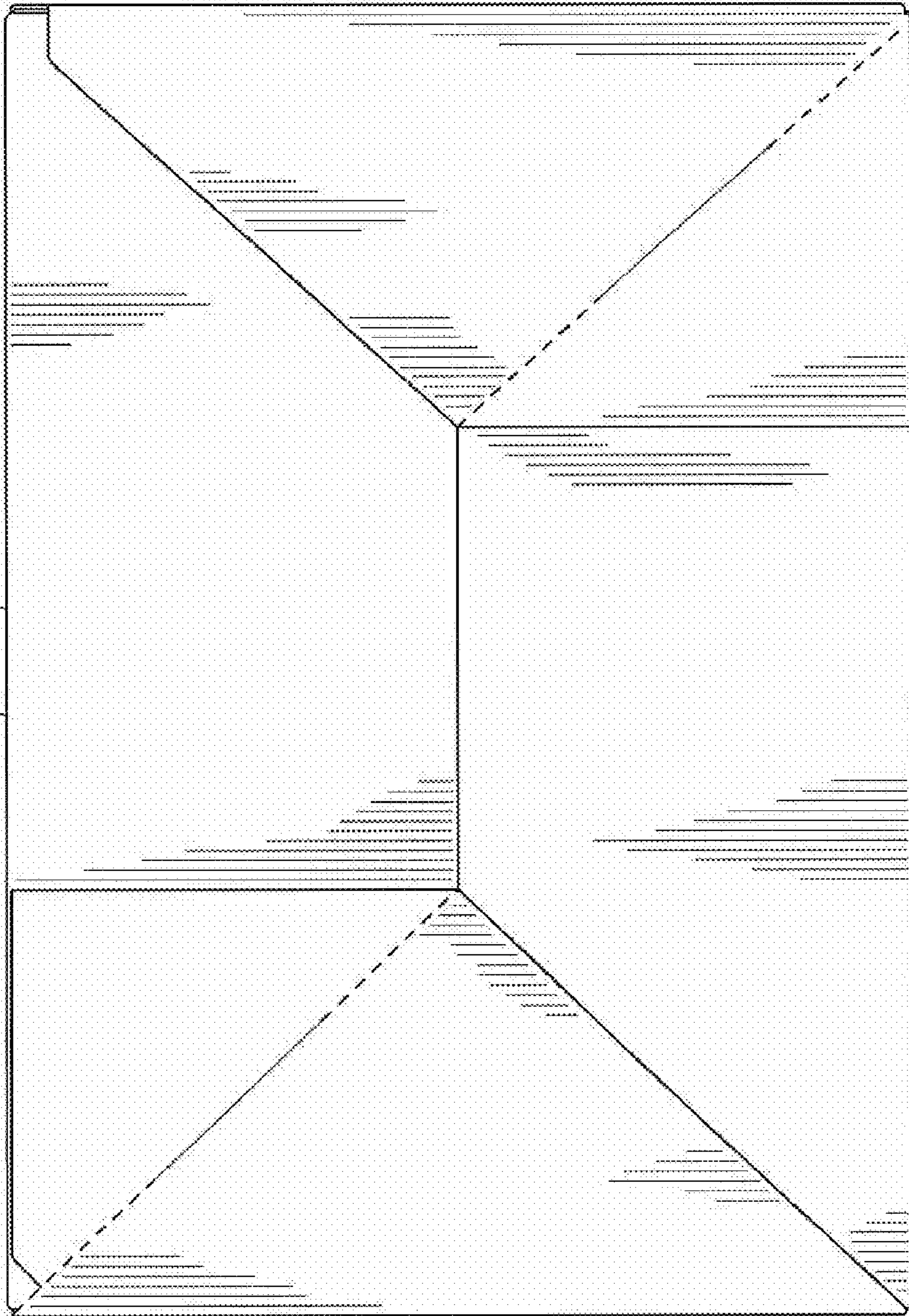

FIG. 7

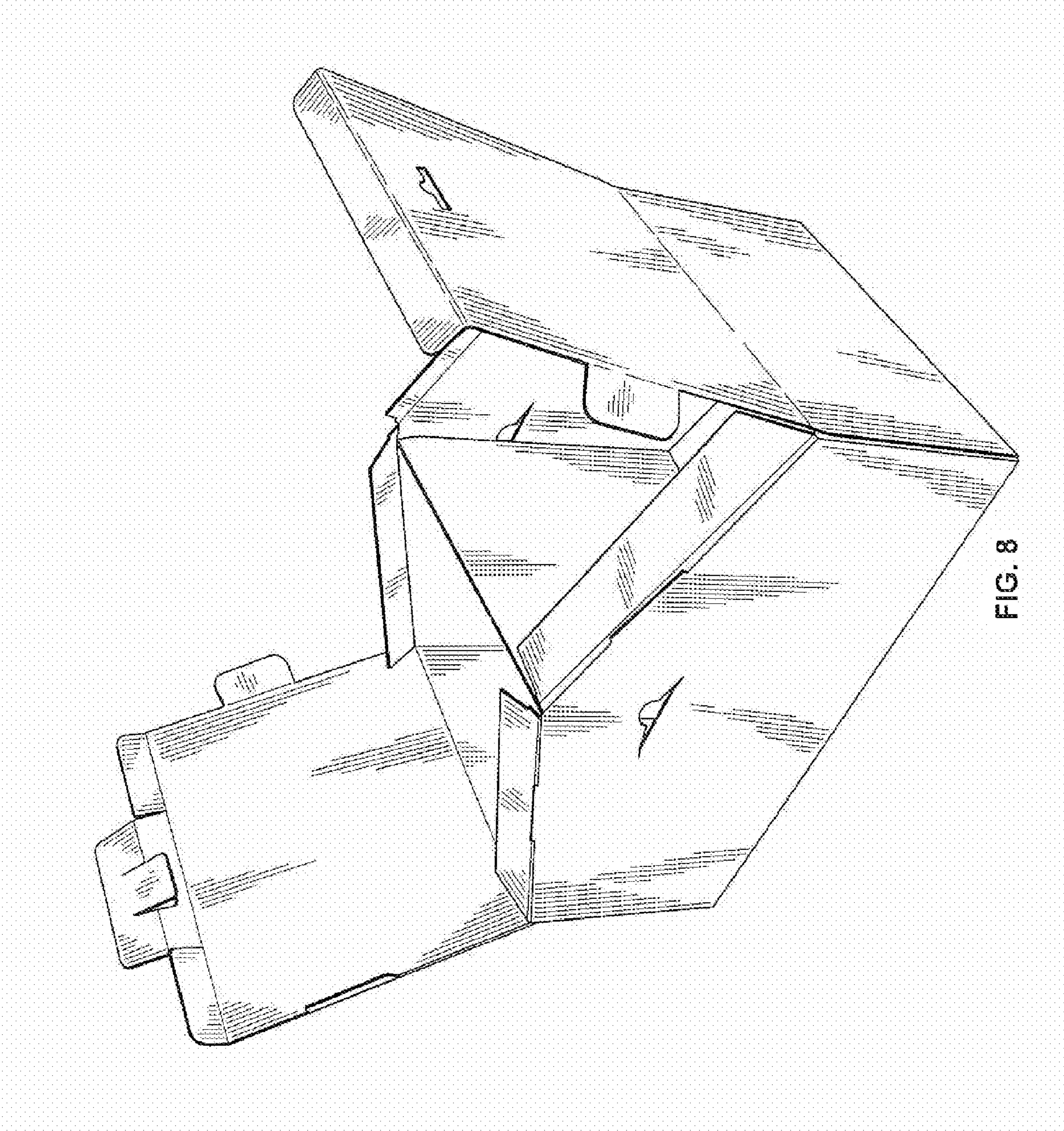

FIG. 8