



US00D554954S

(12) **United States Design Patent**
Germany et al.

(10) **Patent No.:** **US D554,954 S**

(45) **Date of Patent:** **** Nov. 13, 2007**

(54) **COMBINED SALT AND PEPPER DISPENSER**

(75) Inventors: **Jason O. Germany**, Seattle, WA (US);
John R. Prins, Seattle, WA (US)

(73) Assignee: **Chef'n Corporation**, Seattle, WA (US)

(**) Term: **14 Years**

(21) Appl. No.: **29/278,241**

(22) Filed: **Mar. 22, 2007**

Related U.S. Application Data

(62) Division of application No. 29/240,026, filed on Oct. 6, 2005, now Pat. No. Des. 542,605.

(51) **LOC (8) Cl.** **07-06**

(52) **U.S. Cl.** **D7/679**

(58) **Field of Classification Search** D7/679,
D7/590-599, 372; 241/168, 169.1, 285.3,
241/93

See application file for complete search history.

(56) **References Cited**

U.S. PATENT DOCUMENTS

2,490,721 A 12/1949 Via
2,876,956 A 3/1959 Bentley
3,132,851 A 5/1964 Tone et al.
4,374,574 A 2/1983 David

4,697,749 A * 10/1987 Holcomb et al. 241/169
D392,517 S * 3/1998 Holcomb et al. D7/679
D464,852 S 10/2002 Tang
6,606,939 B1 8/2003 Tateno
6,871,808 B2 3/2005 Holcomb et al.
7,007,875 B2 3/2006 Cheng

* cited by examiner

Primary Examiner—Terry A. Wallace

(74) *Attorney, Agent, or Firm*—Seed IP Law Group PLLC

(57) **CLAIM**

The ornamental design for a combined salt and pepper dispenser, as shown and described.

DESCRIPTION

FIG. 1 is an isometric view of the combined salt and pepper dispenser showing our new design.

FIG. 2 is a front elevation view thereof, the rear elevation view being identical to the front elevation.

FIG. 3 is a left side elevation view thereof.

FIG. 4 is a right side elevation view thereof.

FIG. 5 is a top plan view thereof; and,

FIG. 6 is a bottom plan view thereof.

The broken lines in the figures are for illustrative purposes only and form no part of the claimed design.

1 Claim, 4 Drawing Sheets

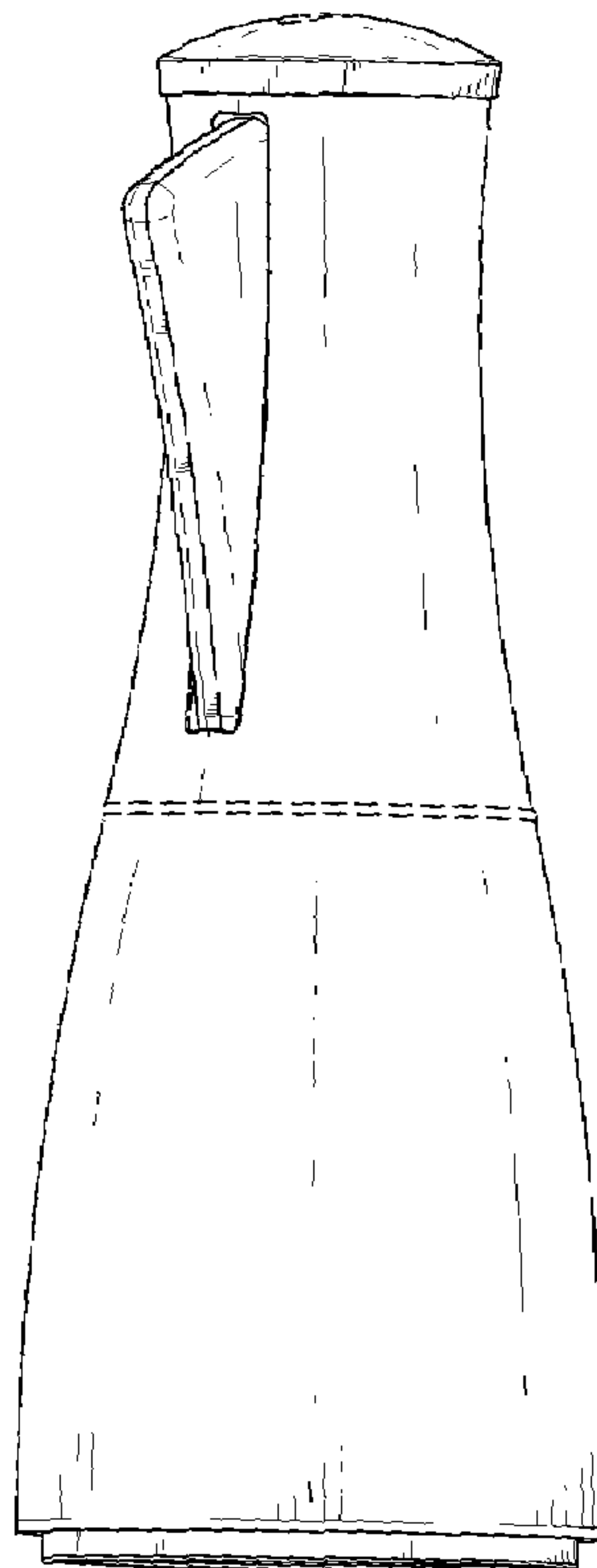

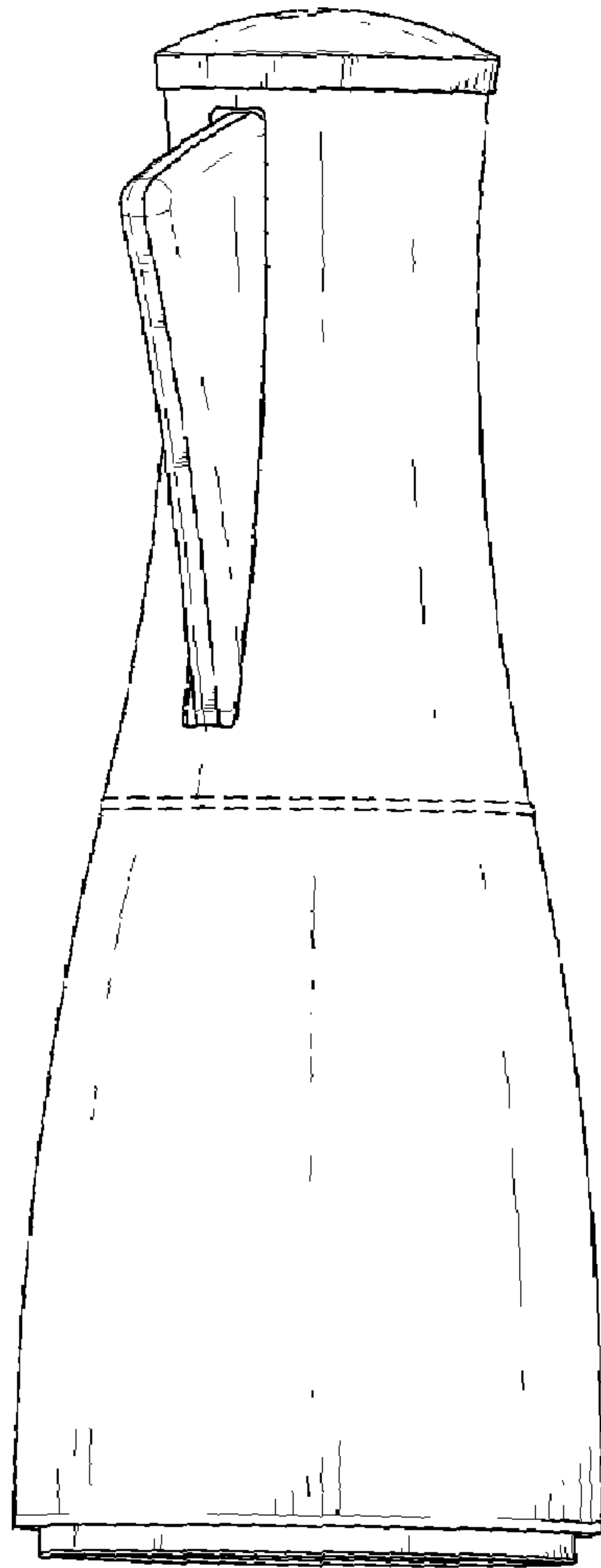

FIG. 1

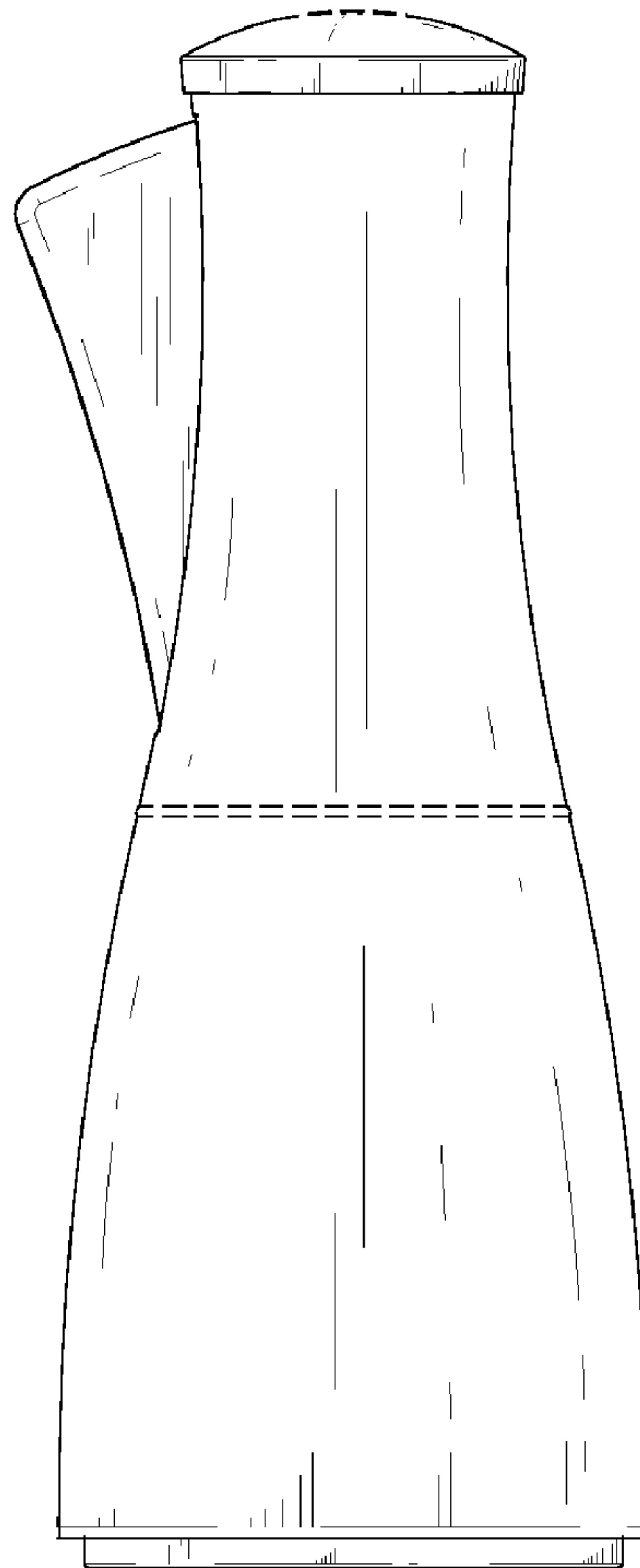

FIG. 2

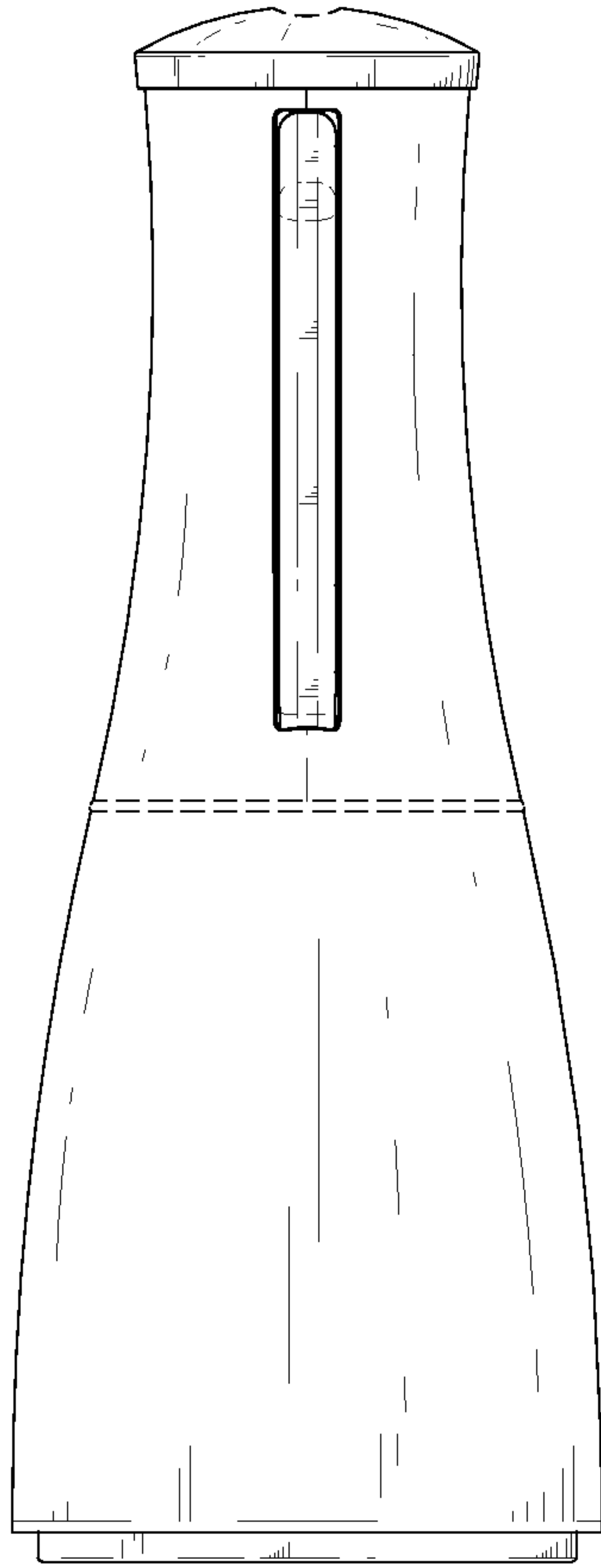

FIG. 3

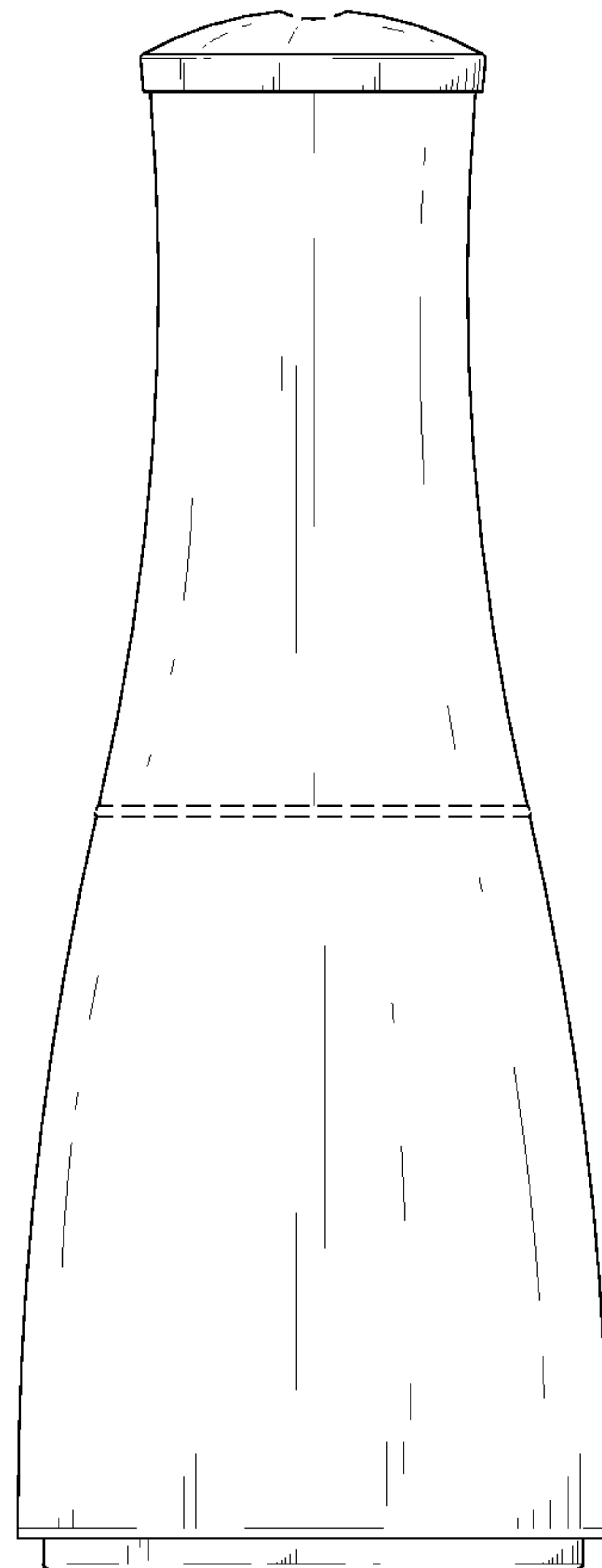

FIG. 4

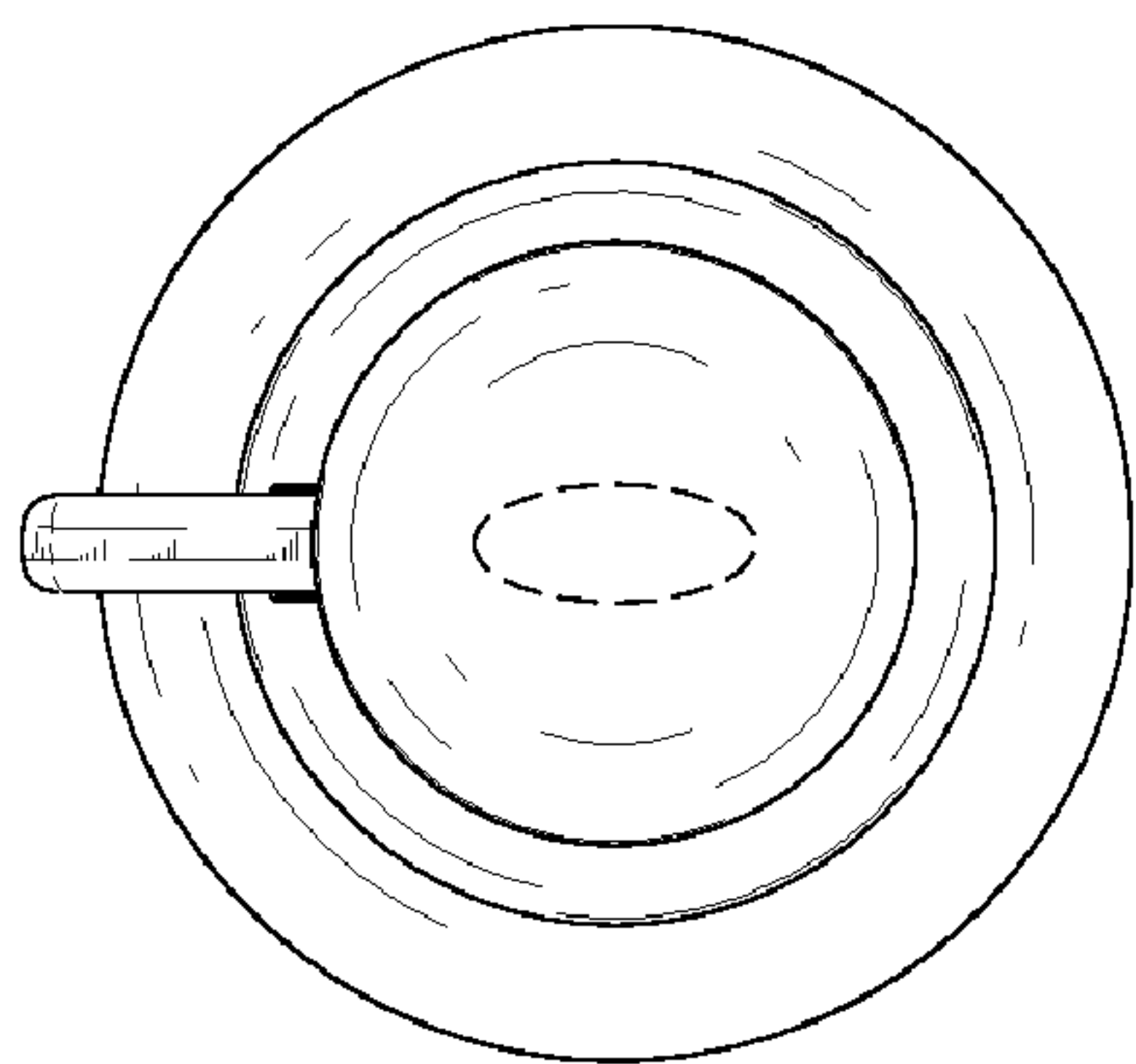

FIG. 5

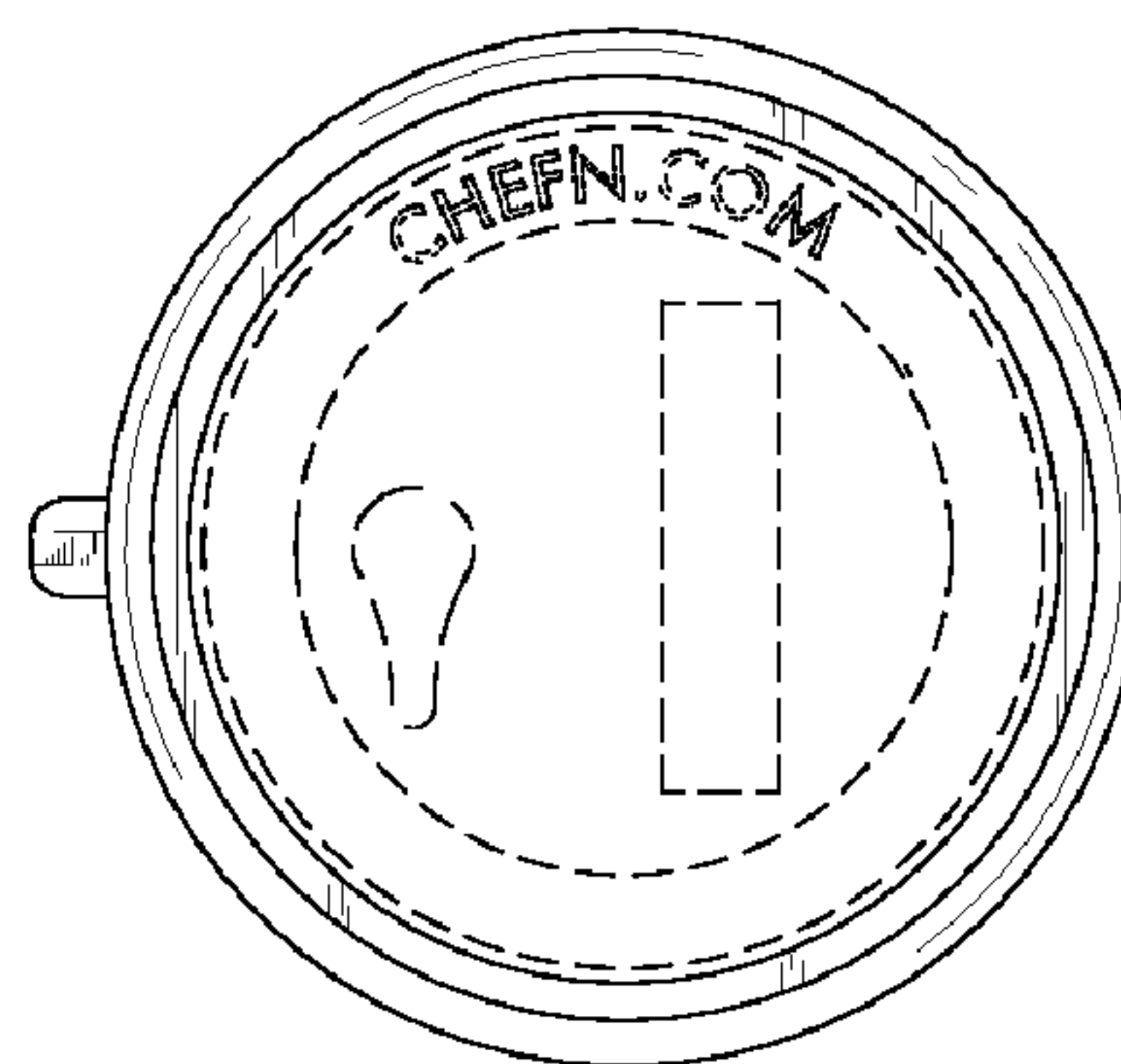

FIG. 6