



US00D554929S

(12) **United States Design Patent**
Jajdelski

(10) **Patent No.:** **US D554,929 S**

(45) **Date of Patent:** **** Nov. 13, 2007**

(54) **MEDIA STORAGE DEVICE**

(76) Inventor: **Ronald E. Jajdelski**, 10456 E.
Telluride Ct., Commerce City, CO (US)
80022

(**) Term: **14 Years**

(21) Appl. No.: **29/250,867**

(22) Filed: **Dec. 4, 2006**

(51) **LOC (8) Cl.** **06-04**

(52) **U.S. Cl.** **D6/629; D6/407**

(58) **Field of Classification Search** D6/396,
D6/407, 629, 631, 632, 634; 206/307.1,
206/308.1, 308.2, 308.3, 445; 312/9.1
See application file for complete search history.

(56) **References Cited**

U.S. PATENT DOCUMENTS

- D155,010 S * 8/1949 Kaplan et al. D19/90
- D433,251 S * 11/2000 Blazeovich D6/467
- D510,673 S * 10/2005 Prata dos Santos D6/629

* cited by examiner

Primary Examiner—Ian Simmons

Assistant Examiner—Dana Sipos

(74) *Attorney, Agent, or Firm*—Neugeboren Law Firm PC

(57) **CLAIM**

The ornamental design for a media storage device, as shown and described.

DESCRIPTION

FIG. 1 is a top, front, left side perspective view of a media storage device showing my new design;

FIG. 2 is a left side elevational view thereof;

FIG. 3 is a rear elevational view thereof;

FIG. 4 is a front elevational view thereof;

FIG. 5 is a top plan view thereof;

FIG. 6 is a bottom plan view thereof; and,

FIG. 7 is a cross sectional view taken along the line 7—7 in FIG. 6.

1 Claim, 7 Drawing Sheets

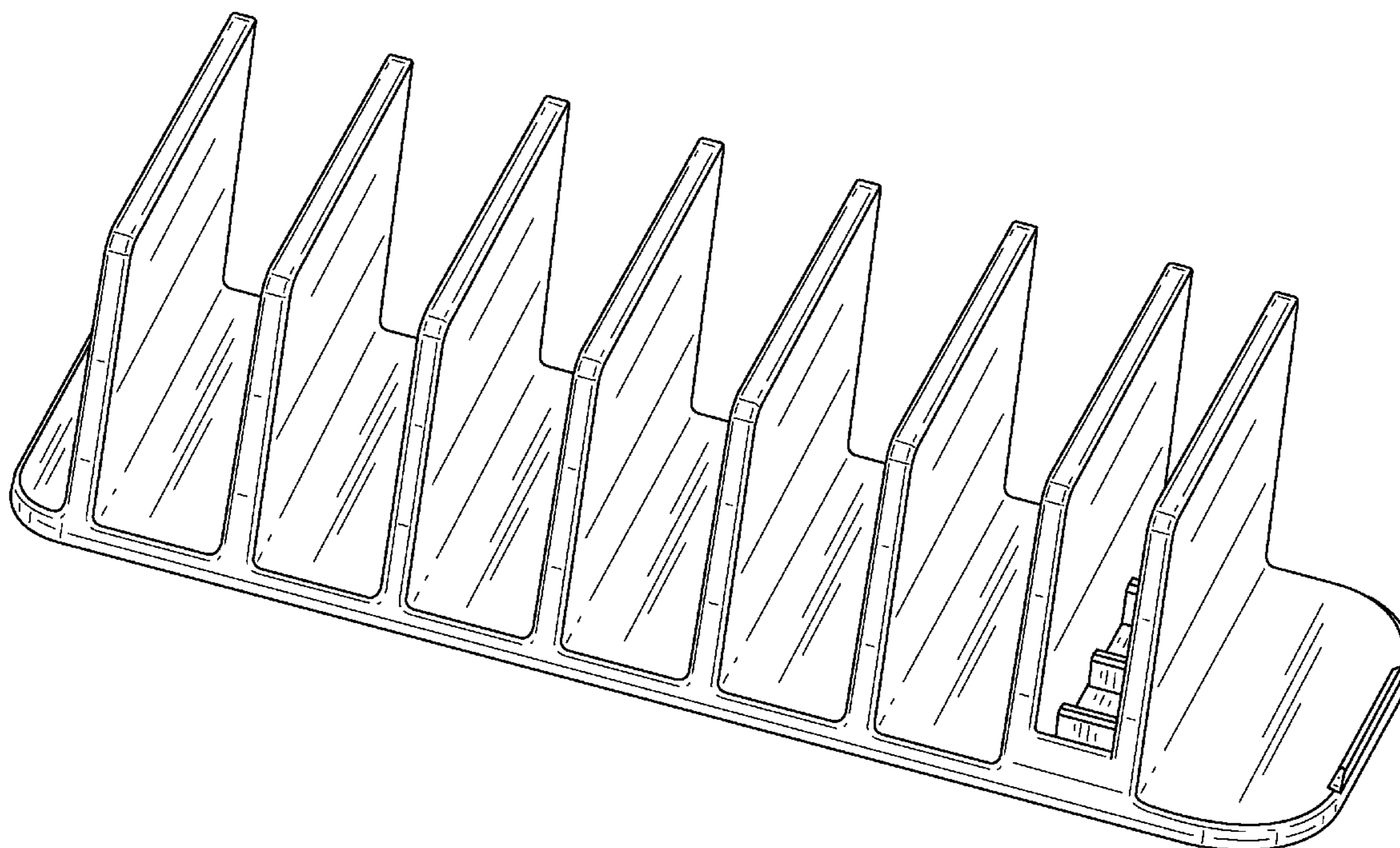

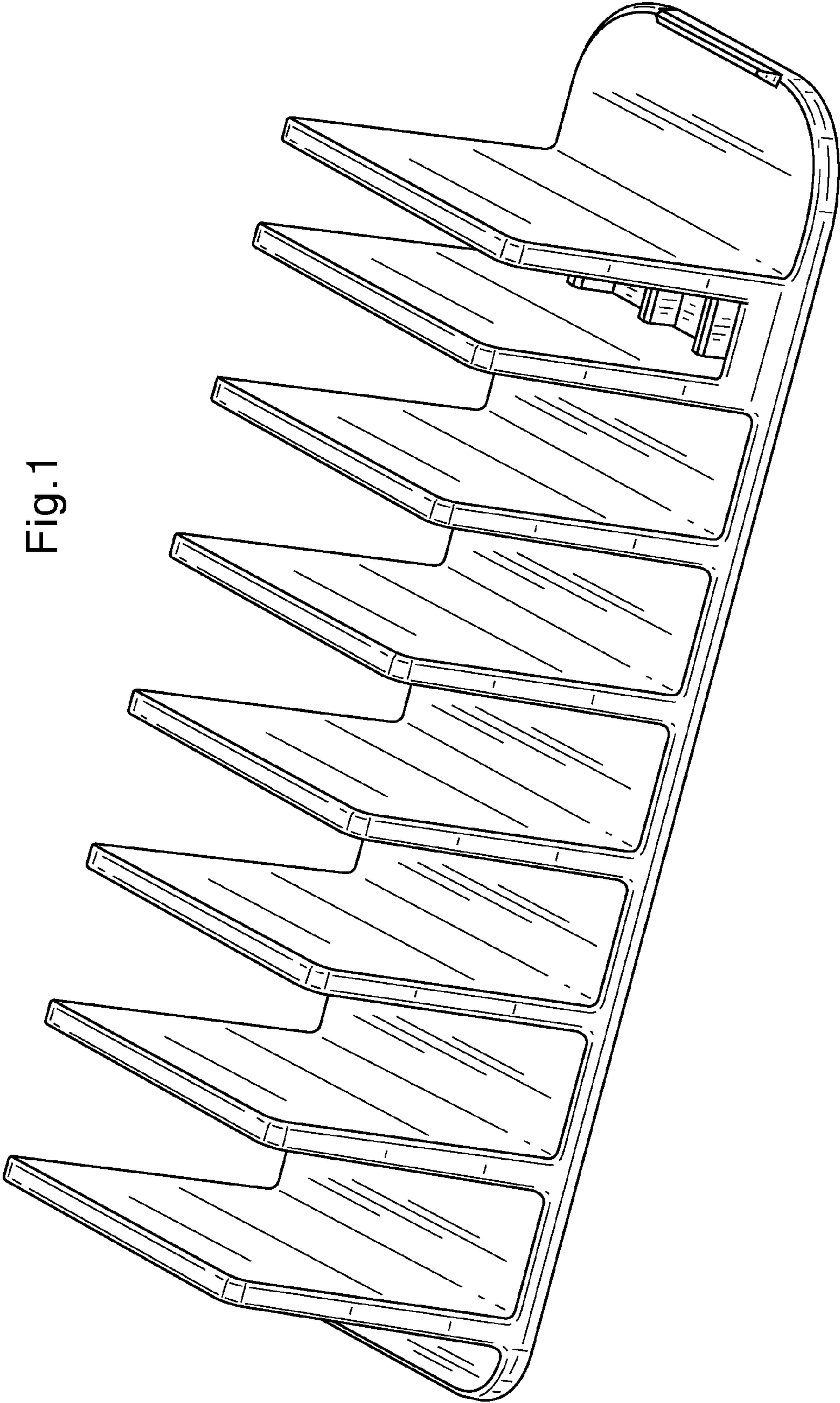

Fig.1

Fig.2

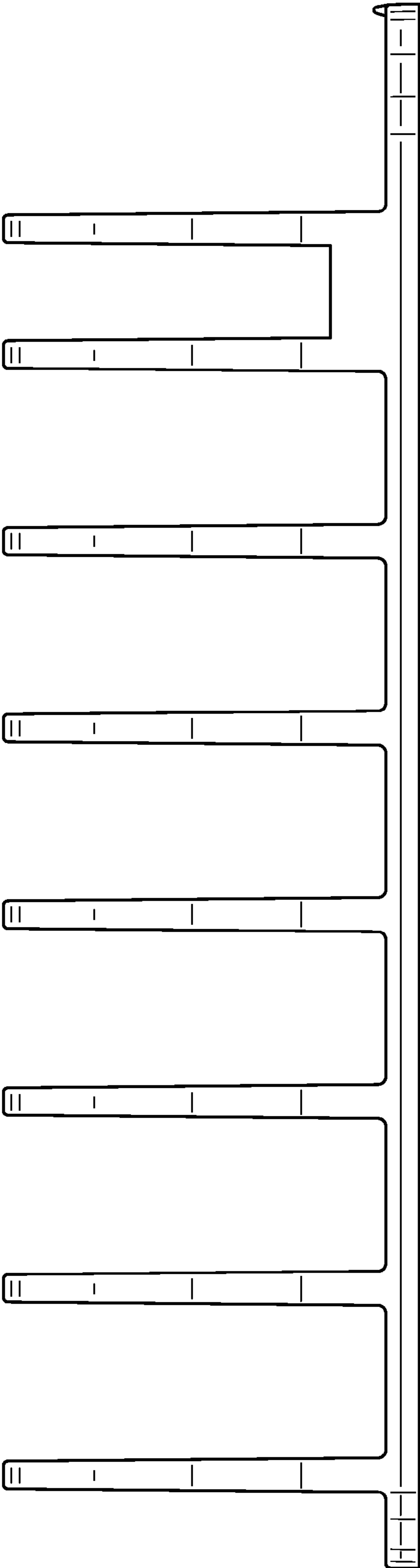

Fig. 3

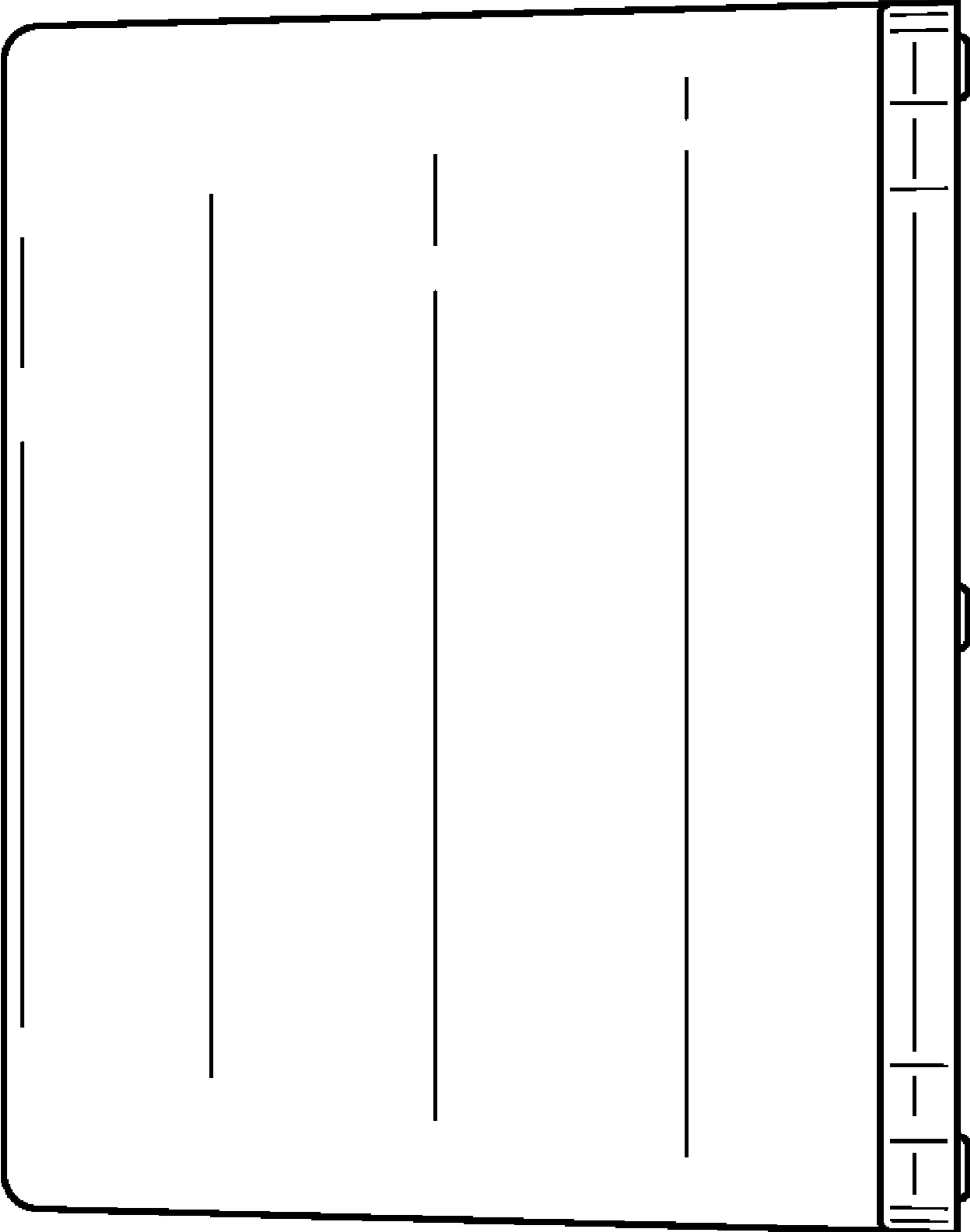

Fig. 4

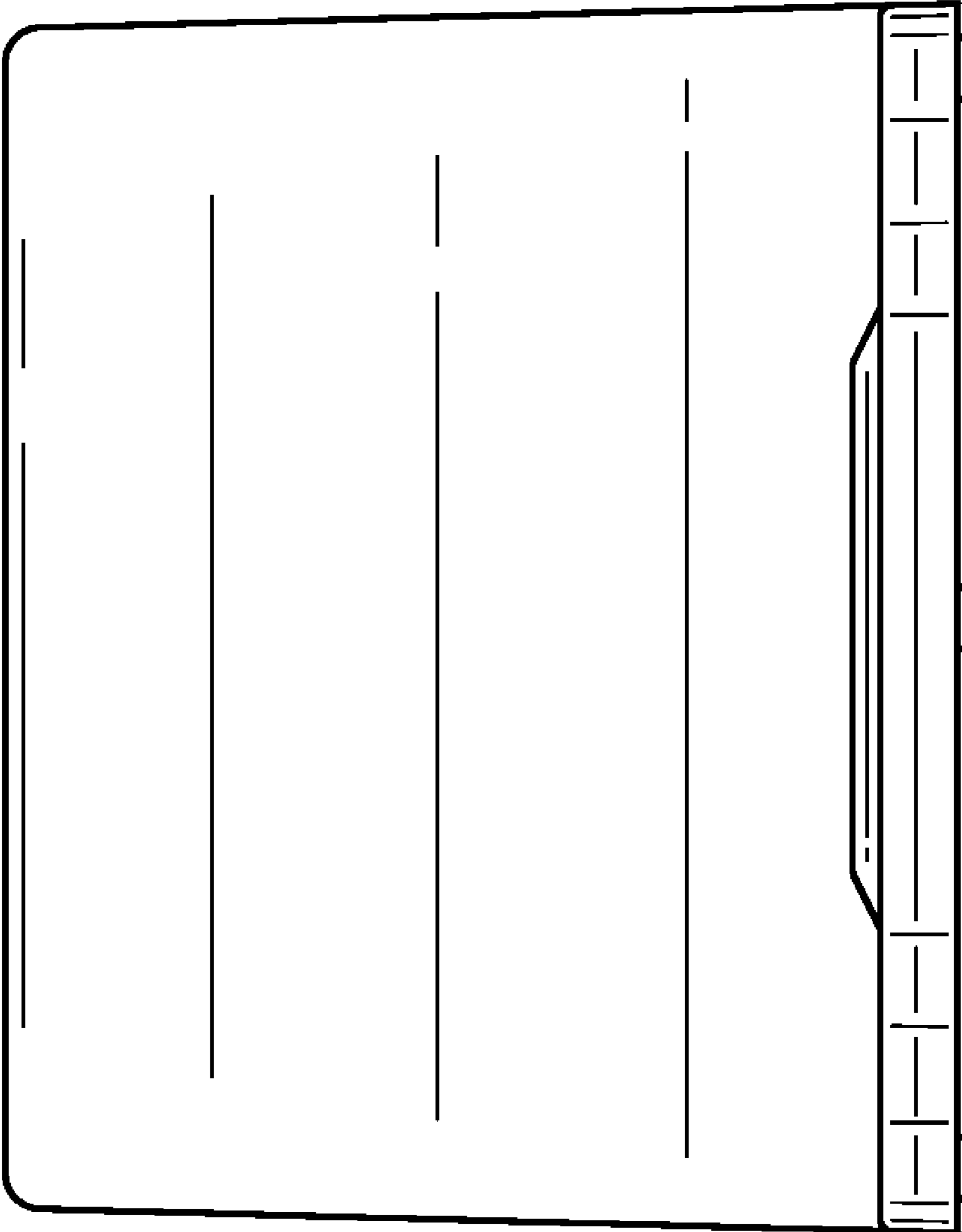

Fig. 5

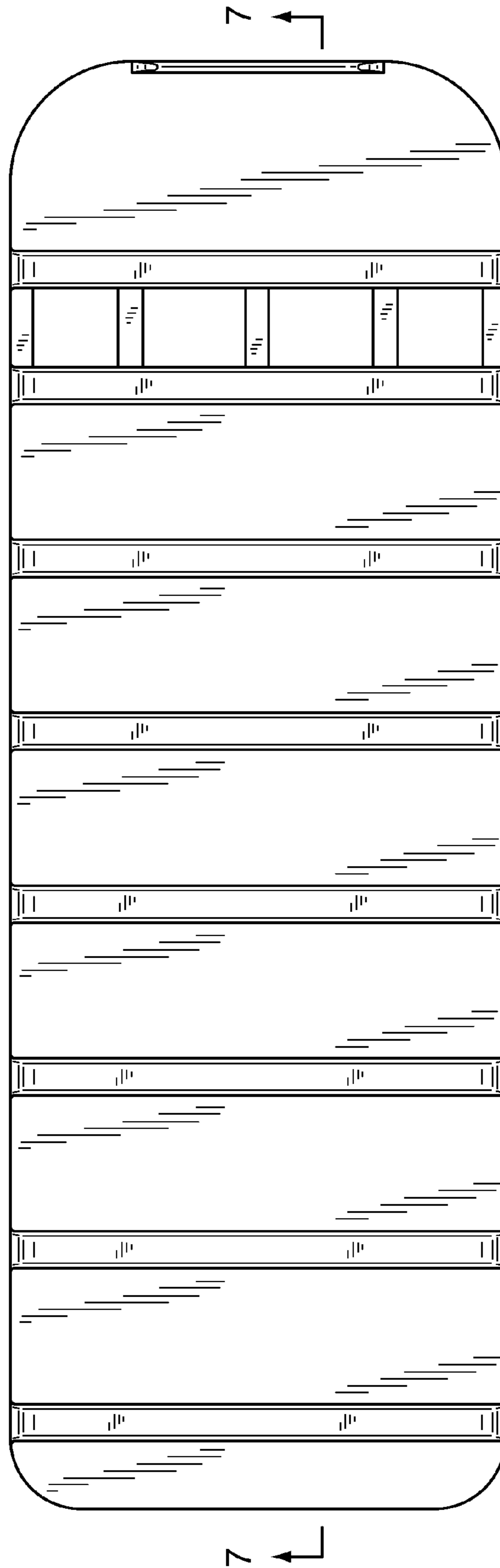

Fig.6

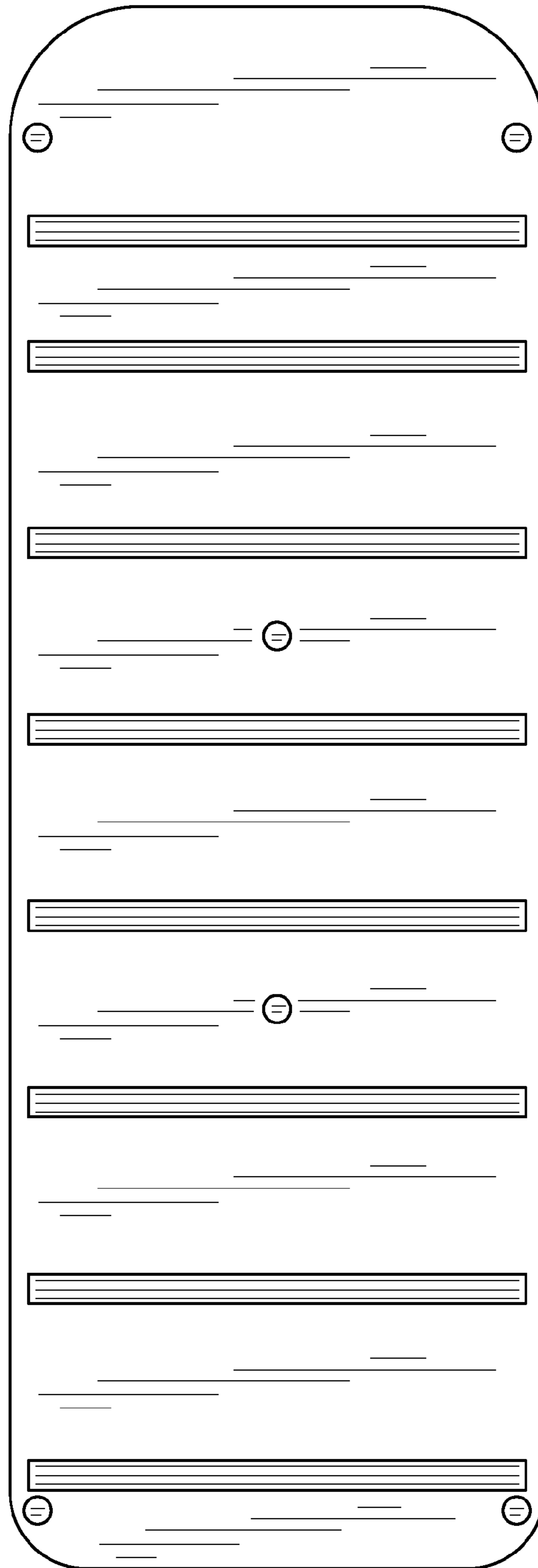

Fig. 7

