



US00D554804S

(12) **United States Design Patent**
Bernard

(10) **Patent No.:** **US D554,804 S**

(45) **Date of Patent:** **** Nov. 6, 2007**

(54) **MAKE-UP CASE**

(75) Inventor: **Valérie Bernard**, Paris (FR)

(73) Assignee: **Alcan Packaging Beauty Services** (FR)

(**) Term: **14 Years**

(21) Appl. No.: **29/257,284**

(22) Filed: **Mar. 31, 2006**

(51) **LOC (8) Cl.** **28-03**

(52) **U.S. Cl.** **D28/83**

(58) **Field of Classification Search** D28/64.1,
D28/64.3, 76-84; 206/581, 823; 132/286,
132/288, 287, 293-307, 312-318

See application file for complete search history.

(56) **References Cited**

U.S. PATENT DOCUMENTS

D285,373	S	*	8/1986	Simonetti et al.	D28/83
5,005,697	A	*	4/1991	Jimbo et al.	206/823
6,138,686	A	*	10/2000	Yuhara	132/294
D475,811	S	*	6/2003	Bontempo	D28/83
D485,018	S	*	1/2004	Beilman	D28/77

* cited by examiner

Primary Examiner—Jennifer Rivard

(74) *Attorney, Agent, or Firm*—Cantor Colburn LLP

(57) **CLAIM**

The ornamental design for a make-up case, as shown and described.

DESCRIPTION

FIG. 1 is a top and front perspective view showing my new make-up case;

FIG. 2 is a top plan view thereof;

FIG. 3 is a front elevation view thereof;

FIG. 4 is a rear elevation view thereof;

FIG. 5 is a side elevation view thereof taken from the right of FIG. 3;

FIG. 6 is a side elevation view thereof taken from the left of FIG. 3;

FIG. 7 is a top and rear perspective view thereof, with the make-up case shown in an open position; and

FIG. 8 is a top plan view thereof, with the make-up case shown in another open position;

FIG. 9 is a top and front perspective view of the make-up case of FIG. 7; and,

FIG. 10 is a top and front perspective view thereof, with the make-up case shown in another open position.

1 Claim, 10 Drawing Sheets

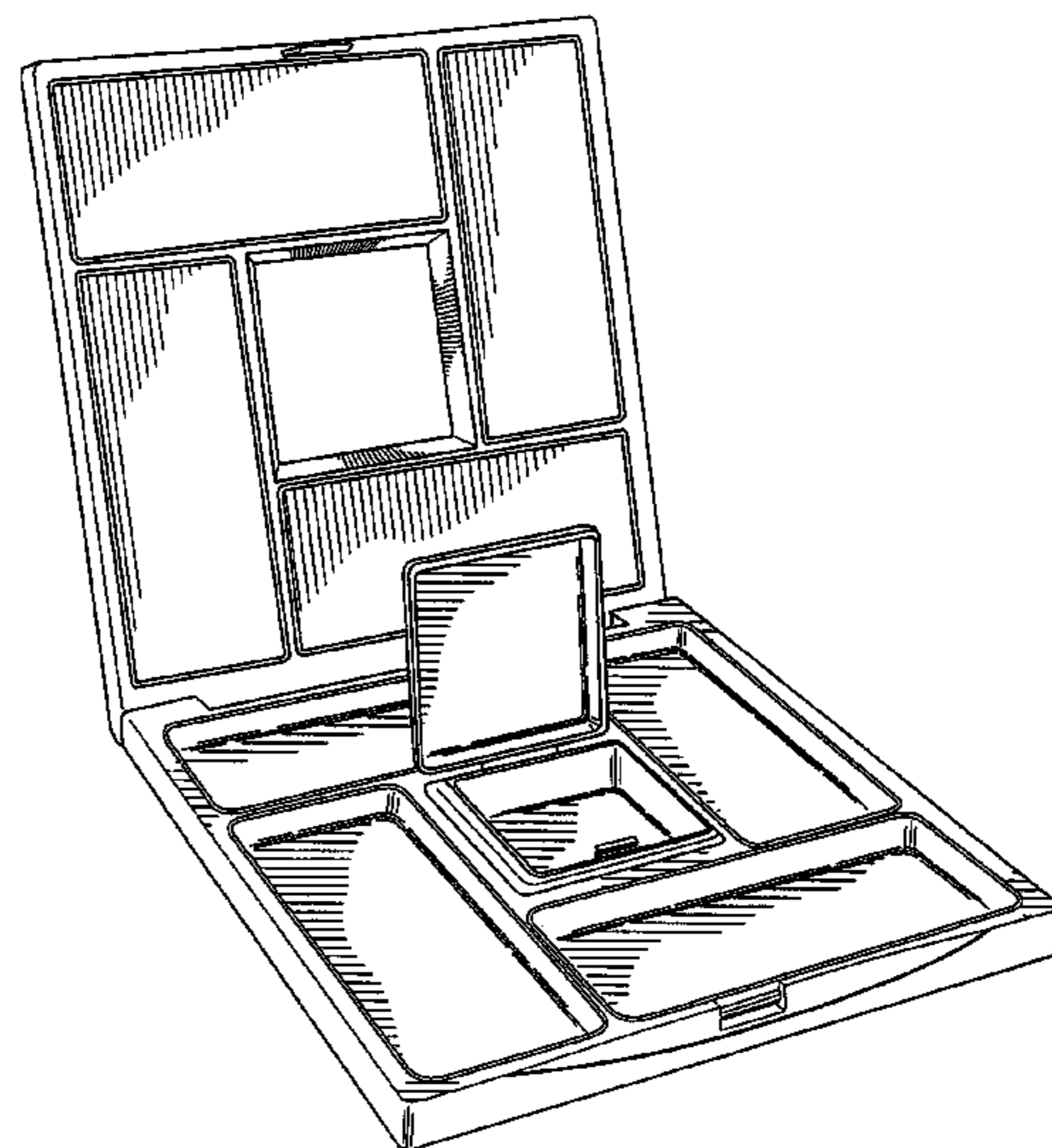
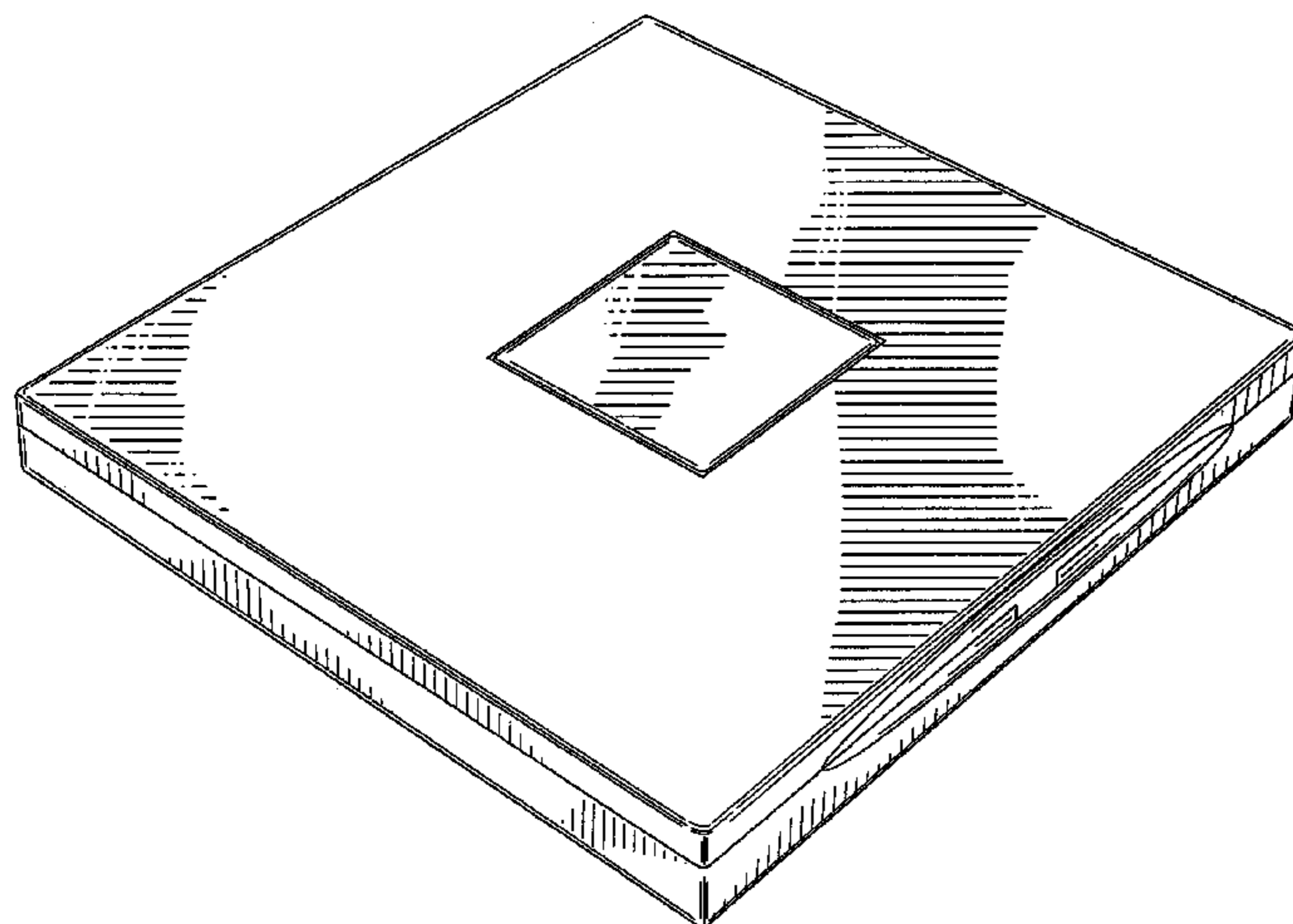

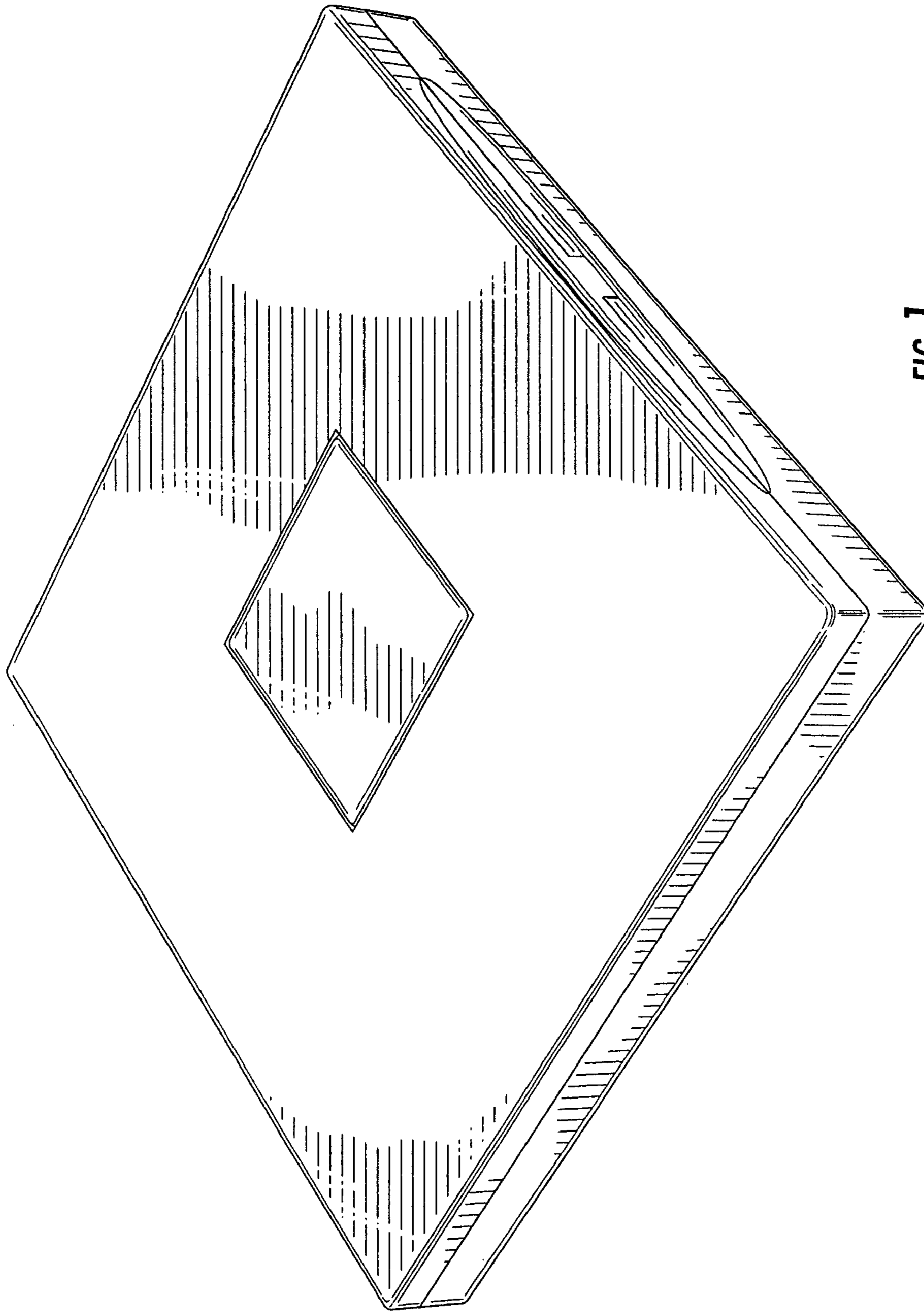

FIG. 1

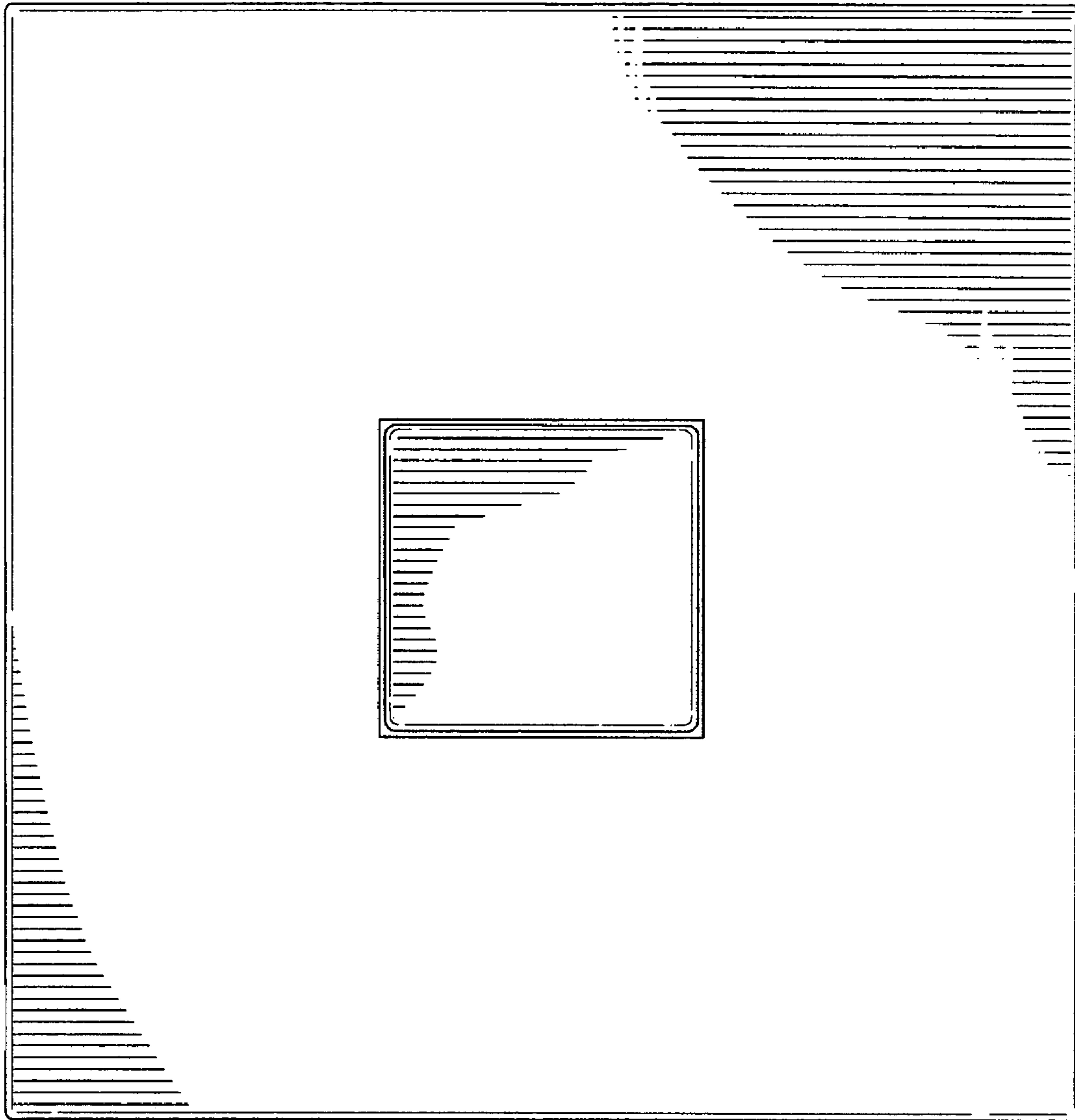

FIG. 2

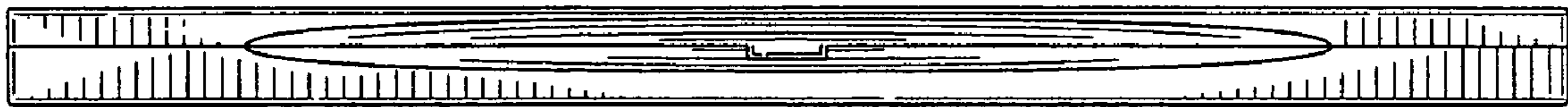

FIG. 3

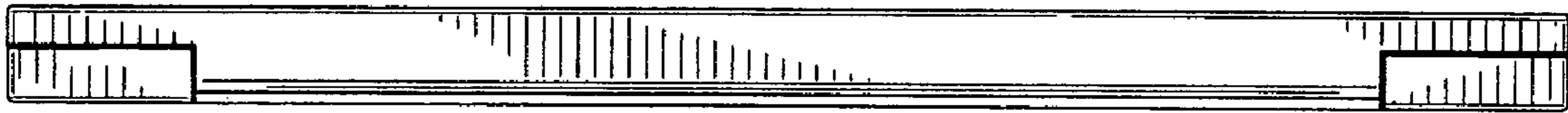

FIG. 4

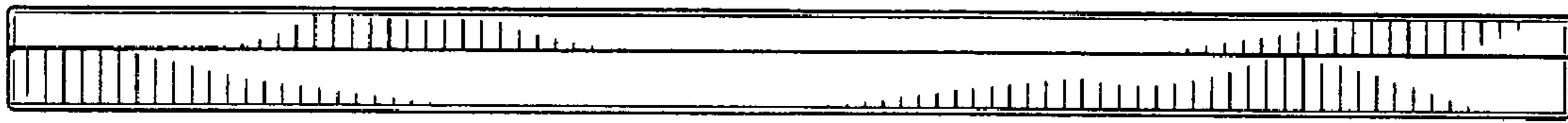

FIG. 5

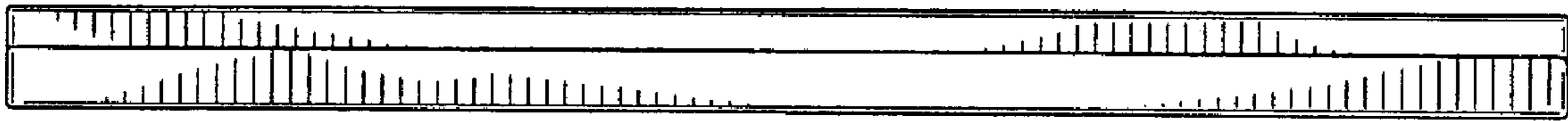

FIG. 6

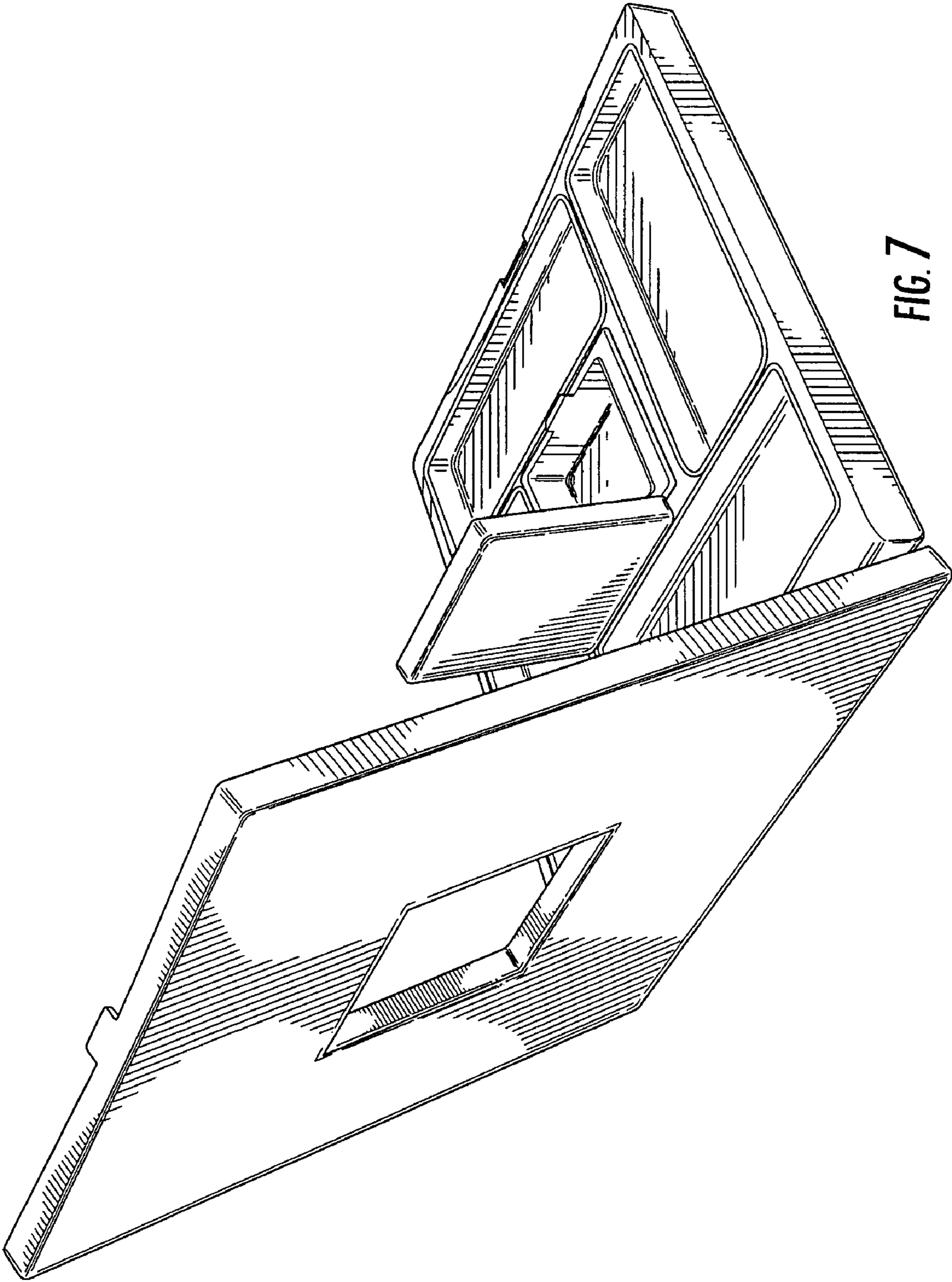

FIG. 7

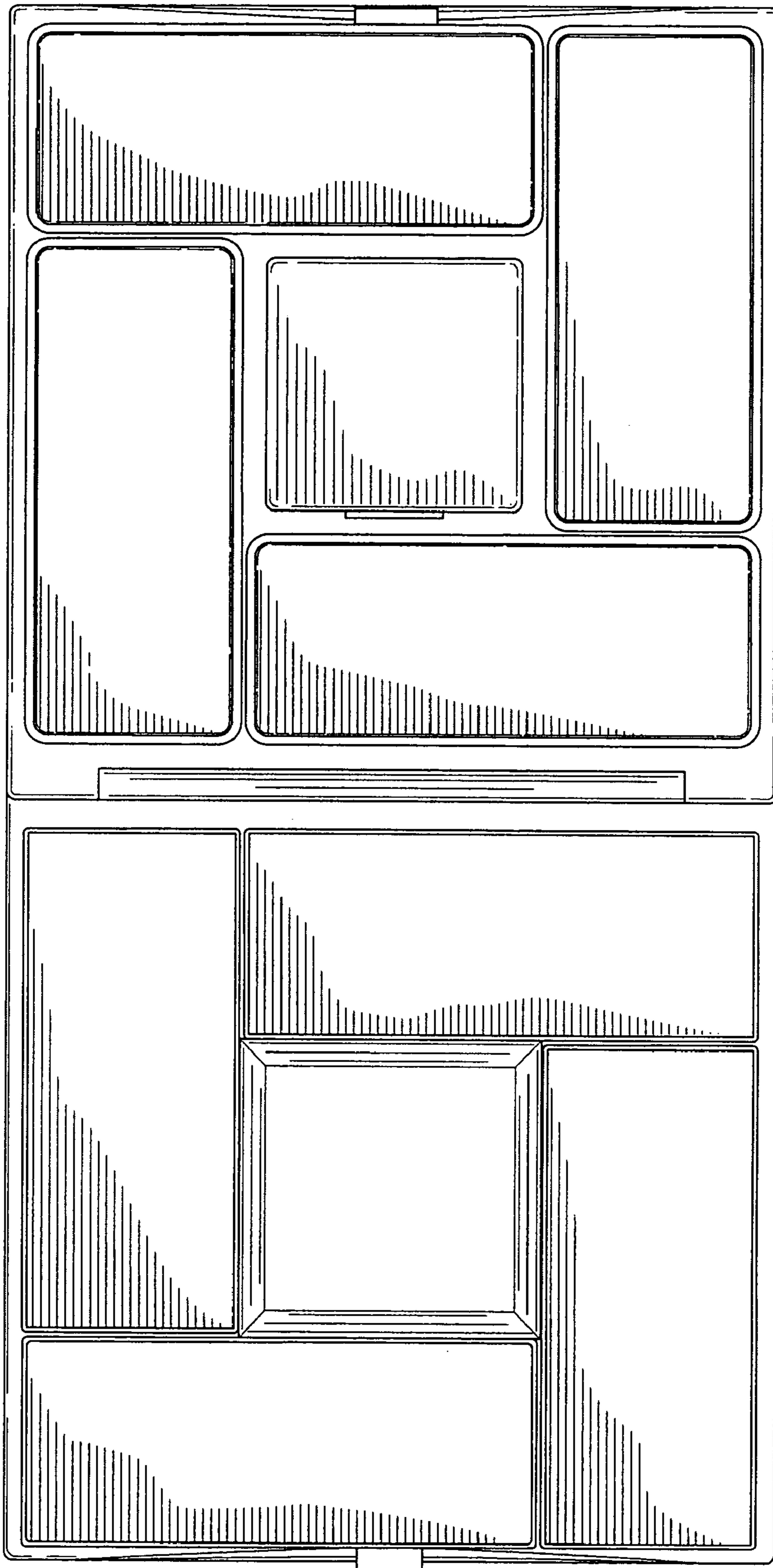

FIG. 8

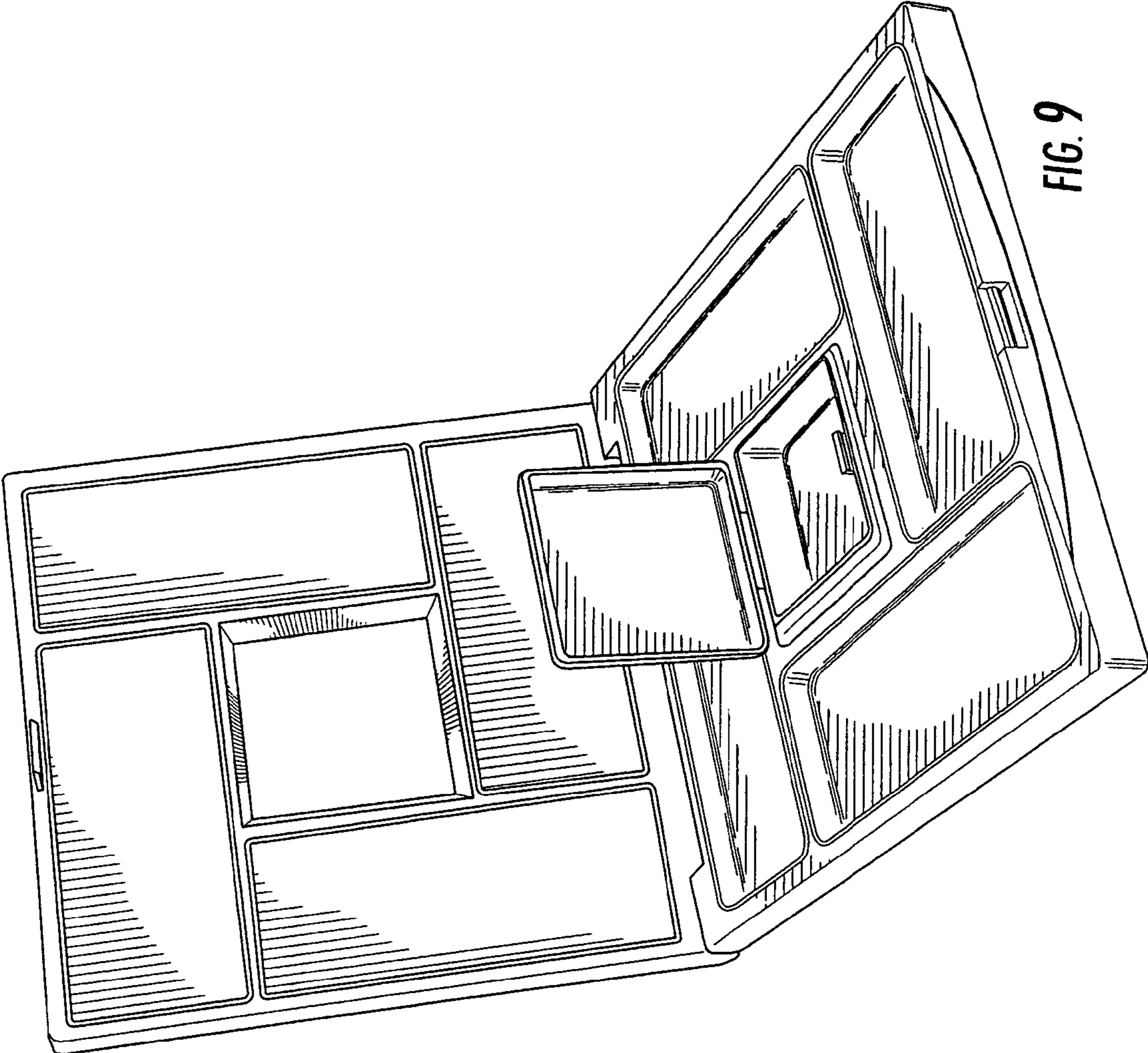

FIG. 9

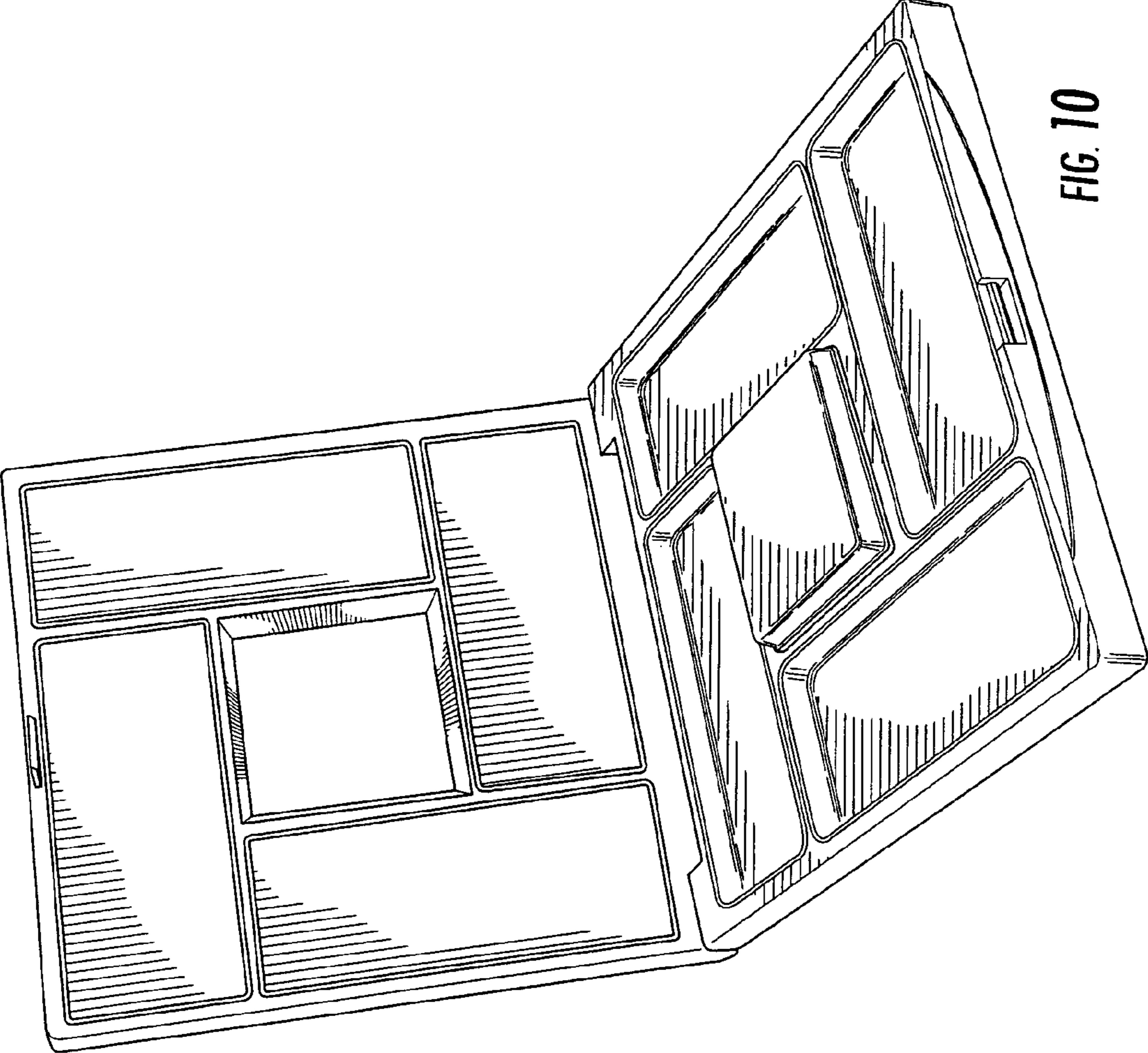

FIG. 10