



US00D554710S

(12) **United States Design Patent** (10) **Patent No.:** **US D554,710 S**  
**Malone et al.** (45) **Date of Patent:** **\*\* Nov. 6, 2007**

(54) **ONLINE AND GAMING KIOSK** D508,269 S \* 8/2005 Wichinsky ..... D21/369  
2001/0054019 A1 12/2001 de Fabrega  
(75) Inventors: **Richard Lee Malone**, Superior, CO 2002/0120577 A1 8/2002 Hans et al.  
(US); **Justin Conrad Lang**, Denver, 2003/0163382 A1 8/2003 Stefanik et al.  
CO (US); **Alan Lewis DuBois, Jr.**, 2003/0191816 A1 10/2003 Landress et al.  
Louisville, CO (US) 2004/0064377 A1 4/2004 Ergo et al.  
2004/0162779 A1 8/2004 Kramer  
(73) Assignee: **Kiosk Information Systems, Inc.**, 2004/0172325 A1 9/2004 Blanco et al.  
Louisville, CO (US) 2004/0218047 A1 11/2004 Goodman et al.  
2004/0254940 A1 12/2004 Brush  
(\*\*) Term: **14 Years** 2005/0071319 A1 3/2005 Kelley et al.  
2005/0076020 A1 4/2005 Huntley et al.  
2005/0076028 A1 4/2005 Kimura  
(21) Appl. No.: **29/262,611** 2005/0091688 A1 4/2005 Chang et al.

(22) Filed: **Jul. 6, 2006**

(51) **LOC (8) Cl.** ..... **21-03**  
(52) **U.S. Cl.** ..... **D21/370; D14/305**  
(58) **Field of Classification Search** ..... D21/325,  
D21/329, 369-371; D14/305-307, 336,  
D14/900-902; D25/16; D99/28; 463/16-17,  
463/25, 46-47; 312/223.2  
See application file for complete search history.

\* cited by examiner

*Primary Examiner*—Sandra L. Morris  
(74) *Attorney, Agent, or Firm*—Faegre & Benson, LLP

(57) **CLAIM**

The ornamental design for online and gaming kiosk, as shown and described.

(56) **References Cited**

**U.S. PATENT DOCUMENTS**

5,114,157 A \* 5/1992 Kita ..... 463/46  
D375,726 S \* 11/1996 Witte ..... D14/305  
D404,025 S \* 1/1999 Van Horne et al. .... D14/902  
5,949,688 A 9/1999 Montoya et al.  
5,950,173 A 9/1999 Perkowski  
5,963,916 A 10/1999 Kaplan  
6,032,130 A 2/2000 Alloul et al.  
D472,936 S \* 4/2003 Ohtomi et al. .... D21/325  
D473,269 S \* 4/2003 Tsuda ..... D21/329  
D496,407 S \* 9/2004 Gadda et al. .... D21/370  
6,851,092 B2 2/2005 Chang et al.

**DESCRIPTION**

FIG. 1 is a perspective view of the online and gaming kiosk showing our new design;  
FIG. 2 is a front elevational view thereof;  
FIG. 3 is a rear elevational view thereof;  
FIG. 4 is a right side elevational view thereof;  
FIG. 5 is a left side elevational view thereof;  
FIG. 6 is a top plan view thereof; and,  
FIG. 7 is a bottom plan view thereof.

**1 Claim, 6 Drawing Sheets**

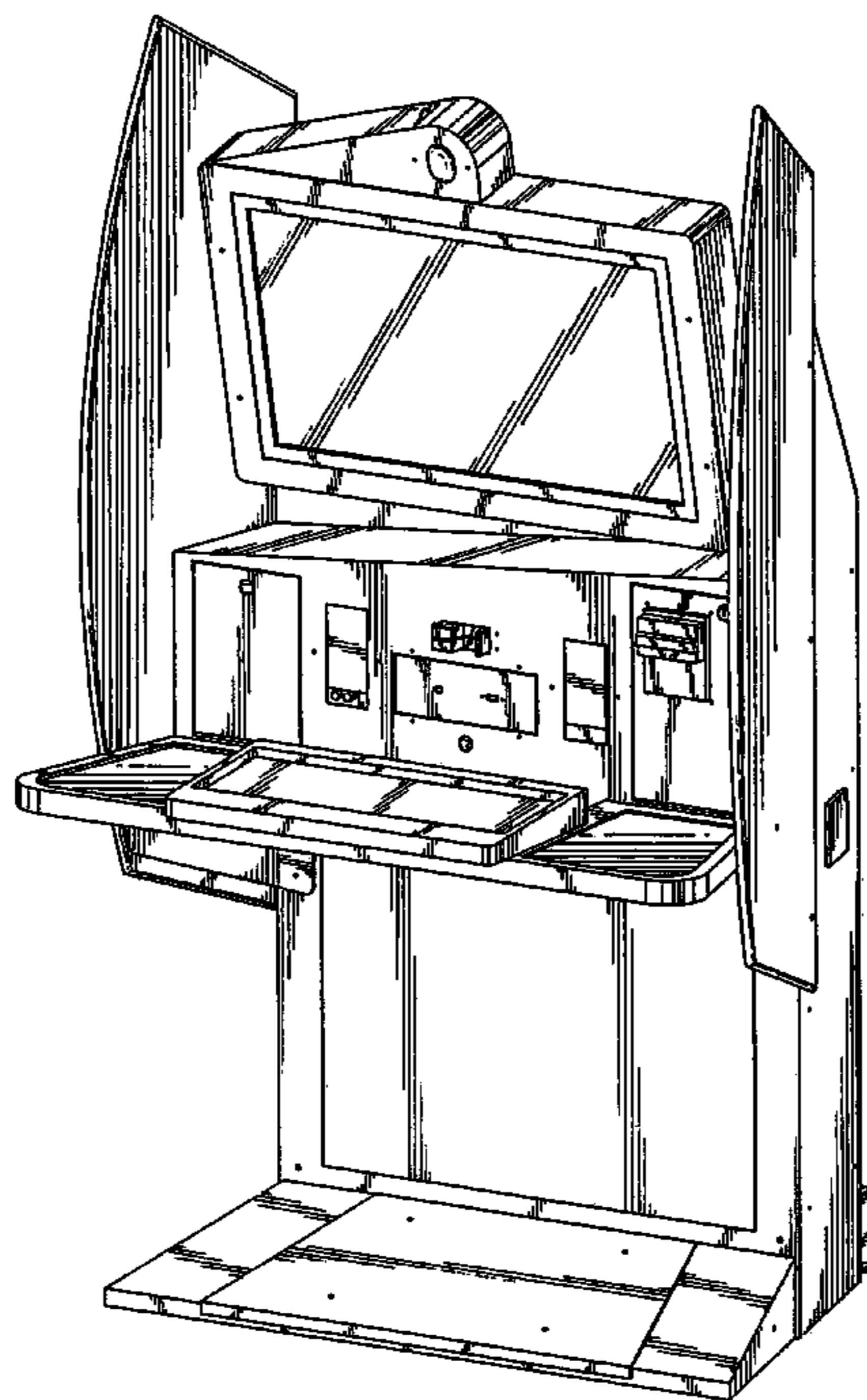

FIG. 1

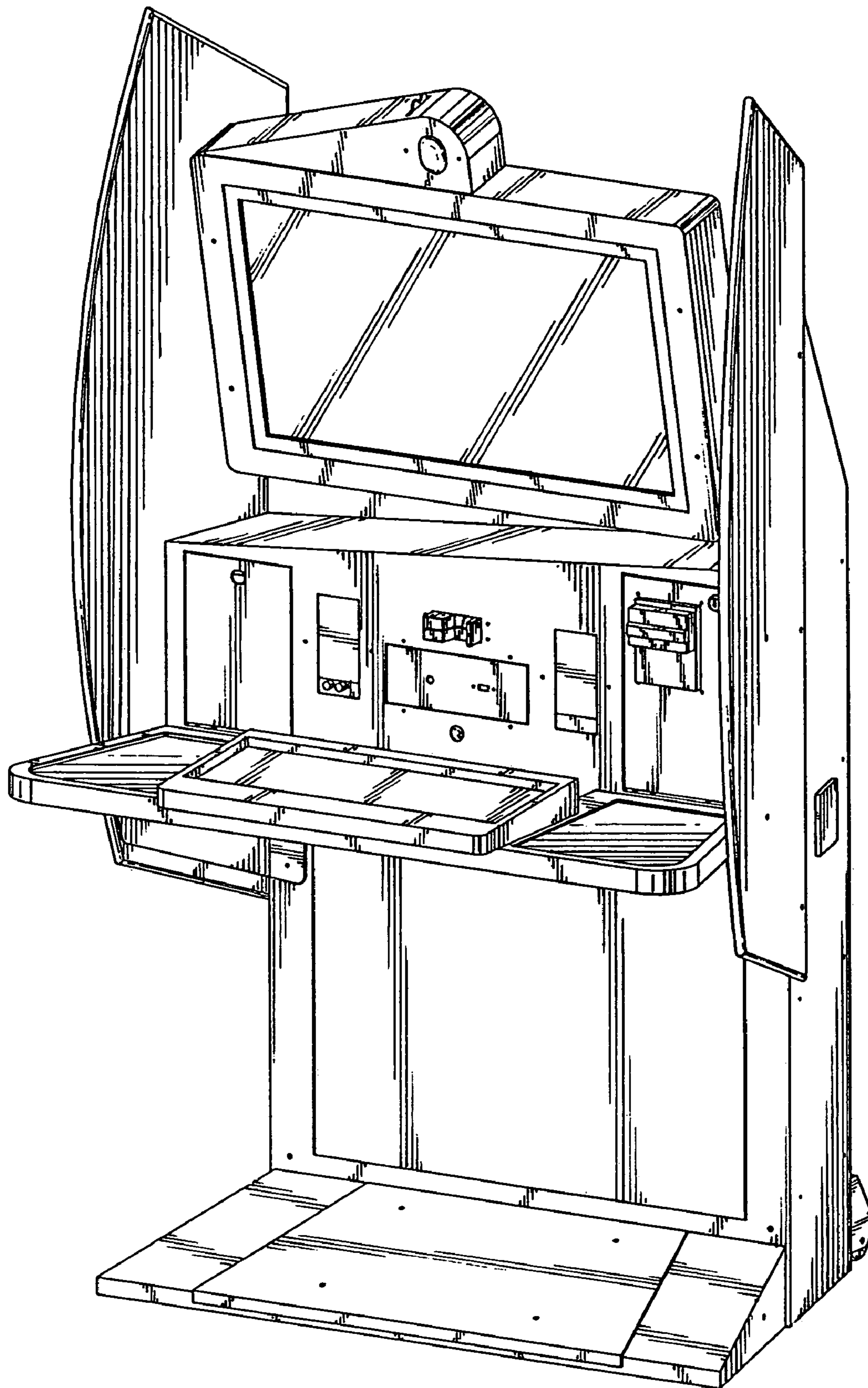

FIG. 2

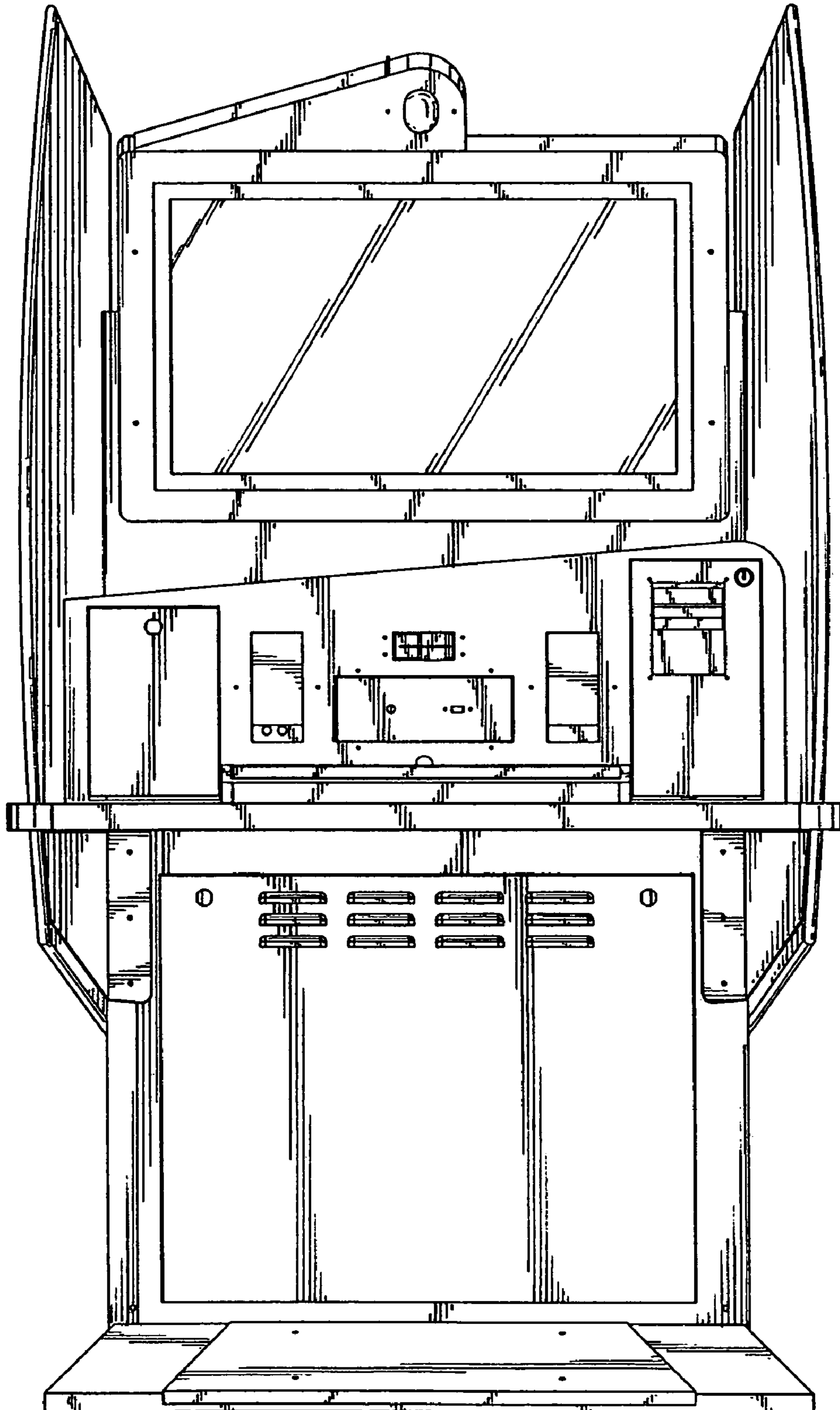

FIG. 3

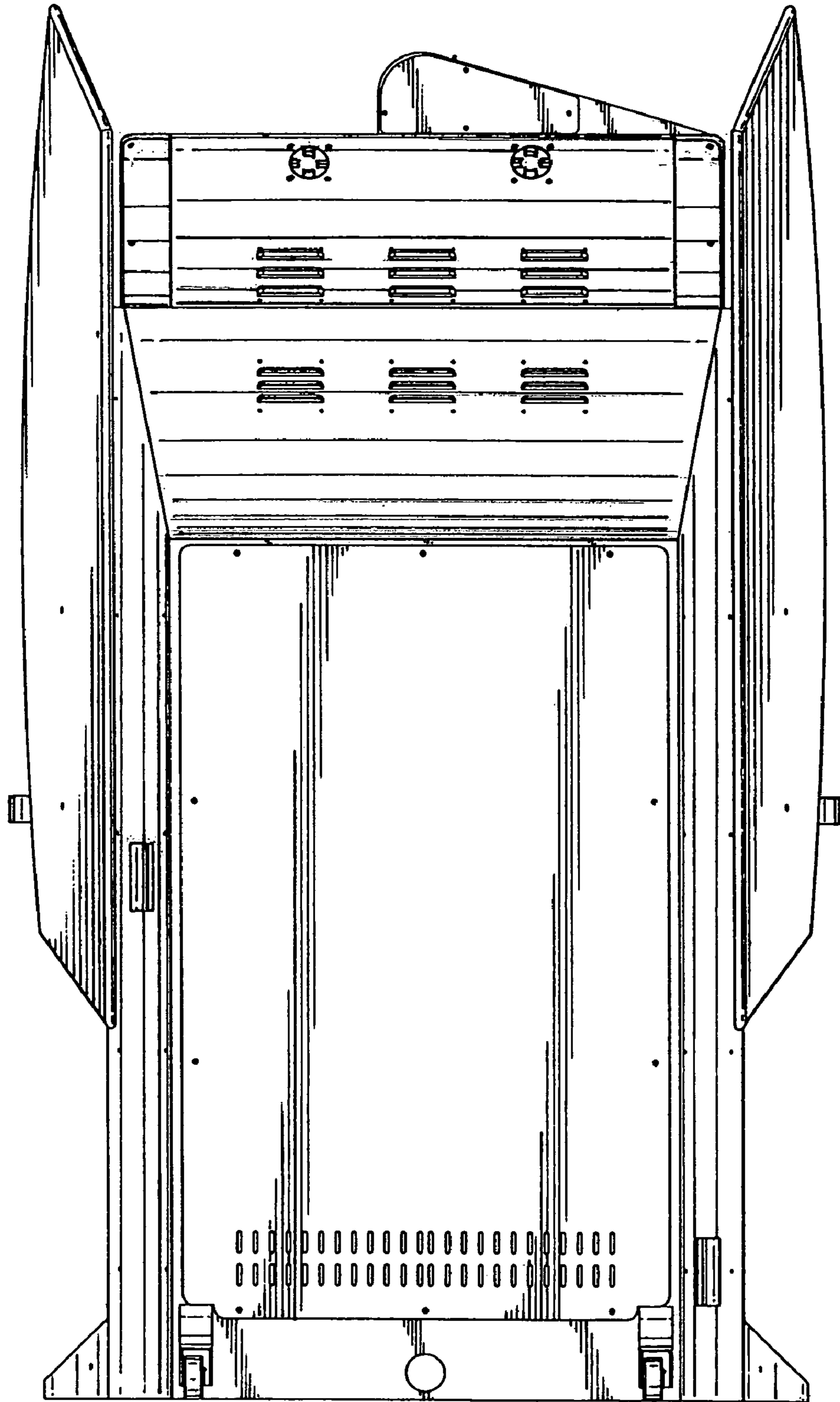

FIG. 4

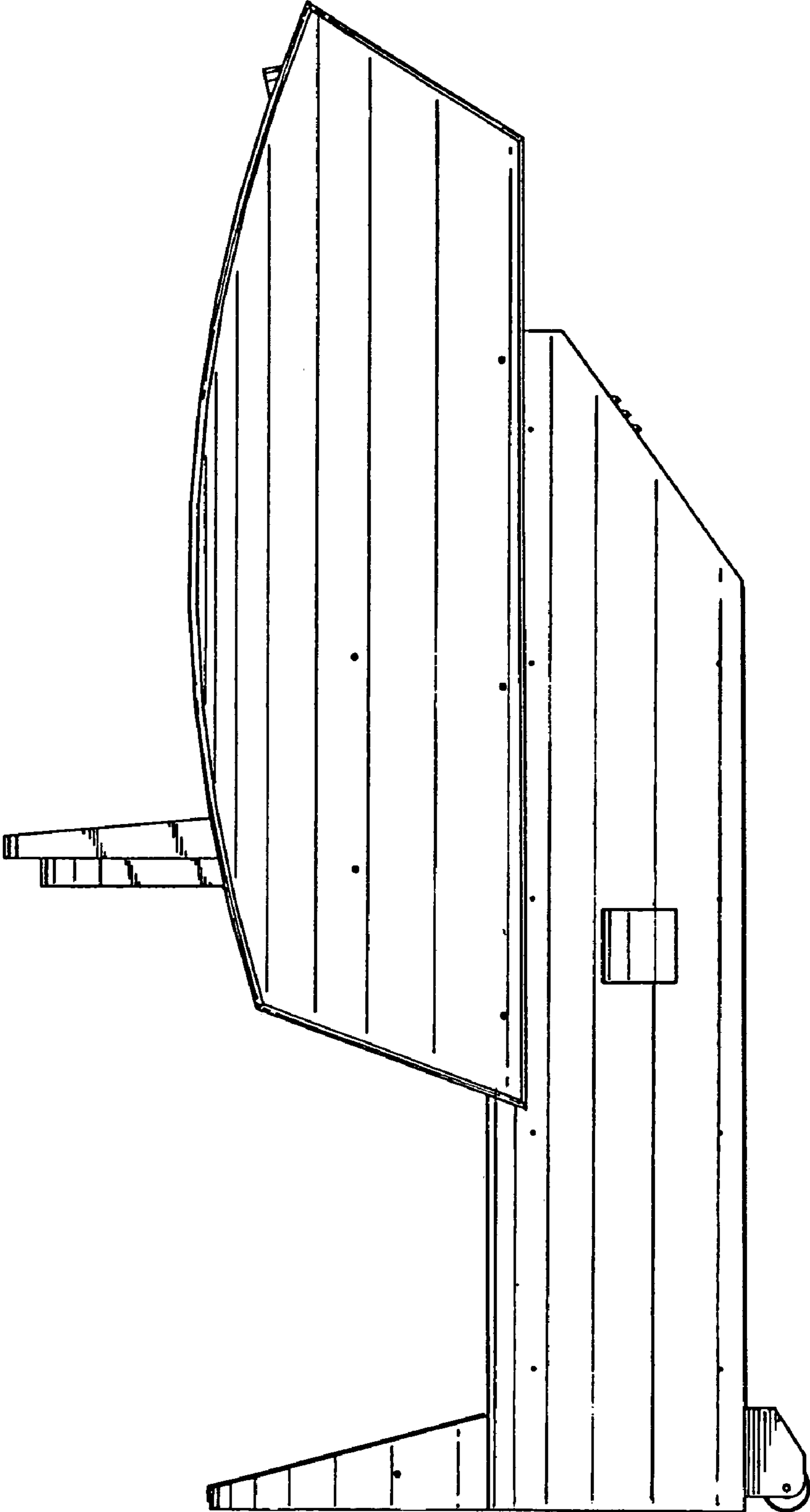

FIG. 5

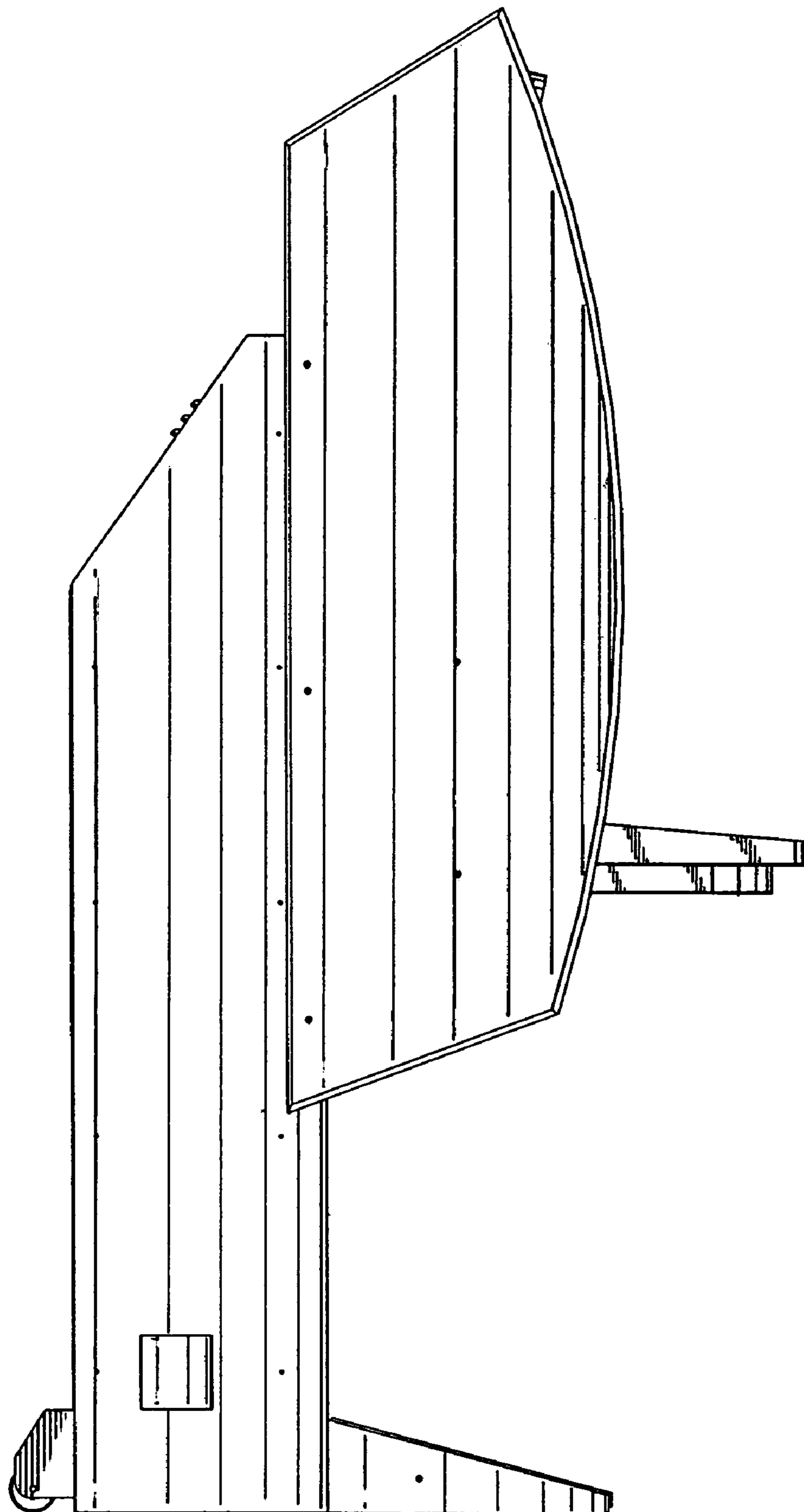

FIG. 6

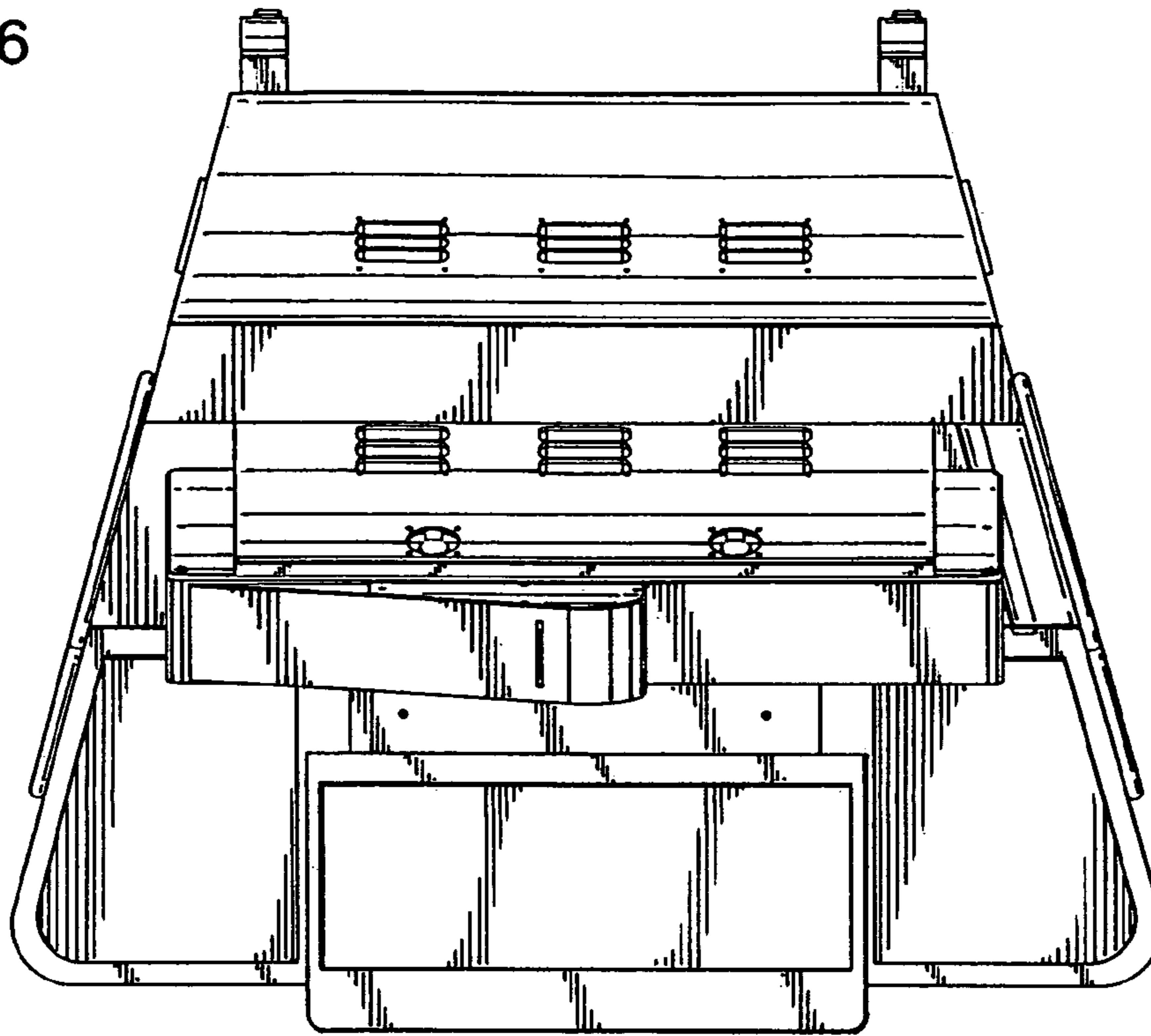

FIG. 7

