



US00D554697S

(12) **United States Design Patent**
Leman et al.

(10) **Patent No.:** **US D554,697 S**
(45) **Date of Patent:** **** Nov. 6, 2007**

(54) **PRINTER**

(75) Inventors: **Michael V. Leman**, Eagle, ID (US);
David B. Larson, Eagle, ID (US);
Angela K. Ogle, Boise, ID (US)

(73) Assignee: **Hewlett-Packard Development Company, L.P.**, Houston, TX (US)

(**) Term: **14 Years**

(21) Appl. No.: **29/254,751**

(22) Filed: **Feb. 28, 2006**

(51) **LOC (8) Cl.** **18-02**

(52) **U.S. Cl.** **D18/50**

(58) **Field of Classification Search** D18/56,
D18/55, 50, 4.3, 12.3, 36-41, 43, 44, 46-49,
D18/14, 18, 21, 51, 54, 54.1, 58, 34.1, 34.9,
D18/35, 35.1, 99; D16/246-248; D14/420-425,
D14/462-470; 399/107

See application file for complete search history.

(56) **References Cited**

U.S. PATENT DOCUMENTS

D450,743 S * 11/2001 Heinz D16/250
D450,757 S * 11/2001 Okamura D18/55

D517,119 S * 3/2006 Suzuki et al. D18/50
D530,737 S * 10/2006 Lim et al. D18/50
D532,043 S * 11/2006 Park et al. D18/50
D537,869 S * 3/2007 Gant et al. D18/54

* cited by examiner

Primary Examiner—Louis S. Zarfaz
Assistant Examiner—Anna K Dworzecka

(57) **CLAIM**

We claim the ornamental design for a printer, as shown and described.

DESCRIPTION

FIG. 1 is a top perspective view of a printer showing our new design;

FIG. 2 is a front elevational view thereof;

FIG. 3 is a top plan view thereof;

FIG. 4 is a right end elevational view thereof; and,

FIG. 5 is a left end elevational view thereof.

The ornamental design which is claimed is shown in solid lines in the drawings. The broken lines in the drawings are for illustrative purposes only and form no part of the claimed design.

1 Claim, 5 Drawing Sheets

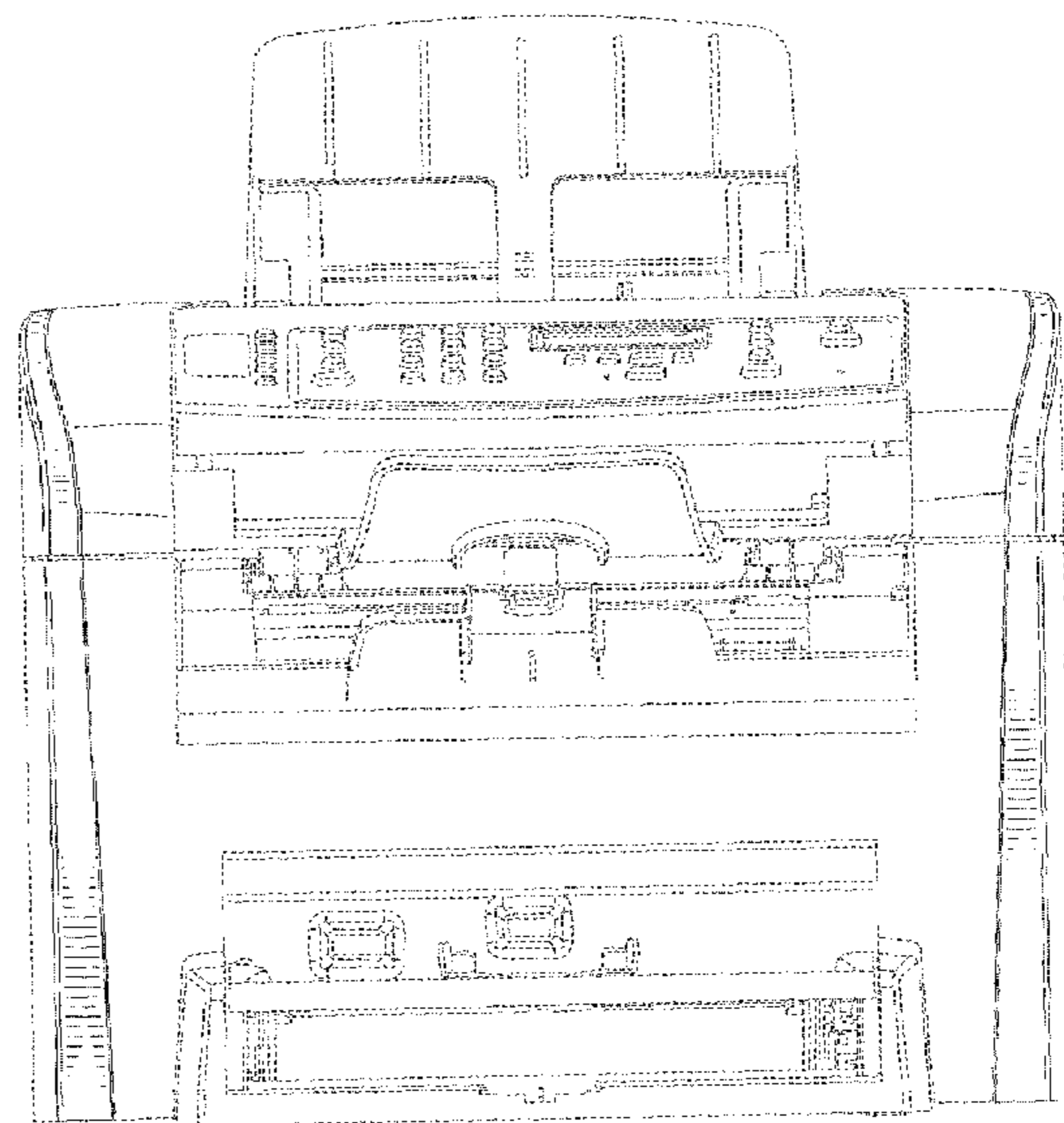
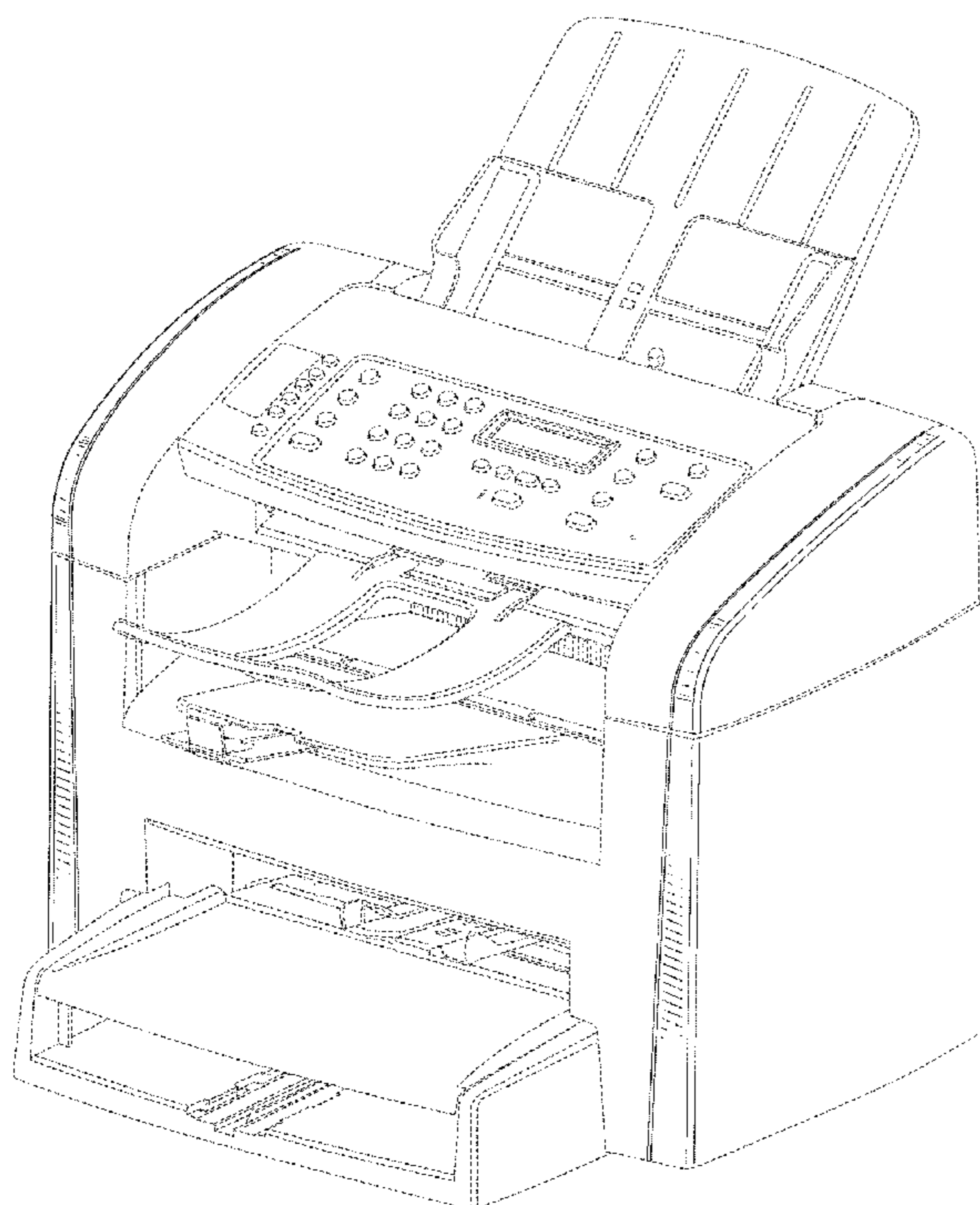

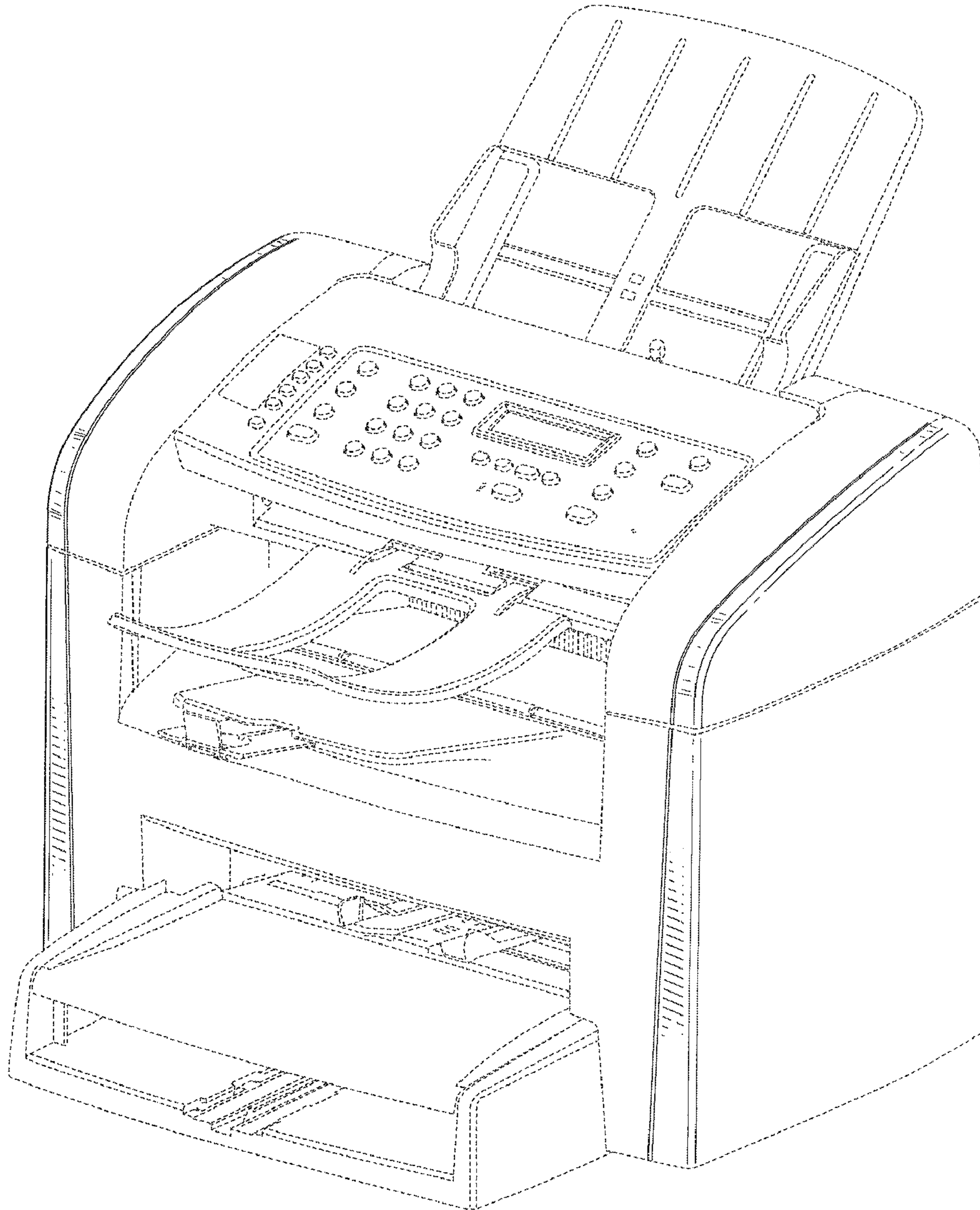

FIG. 1

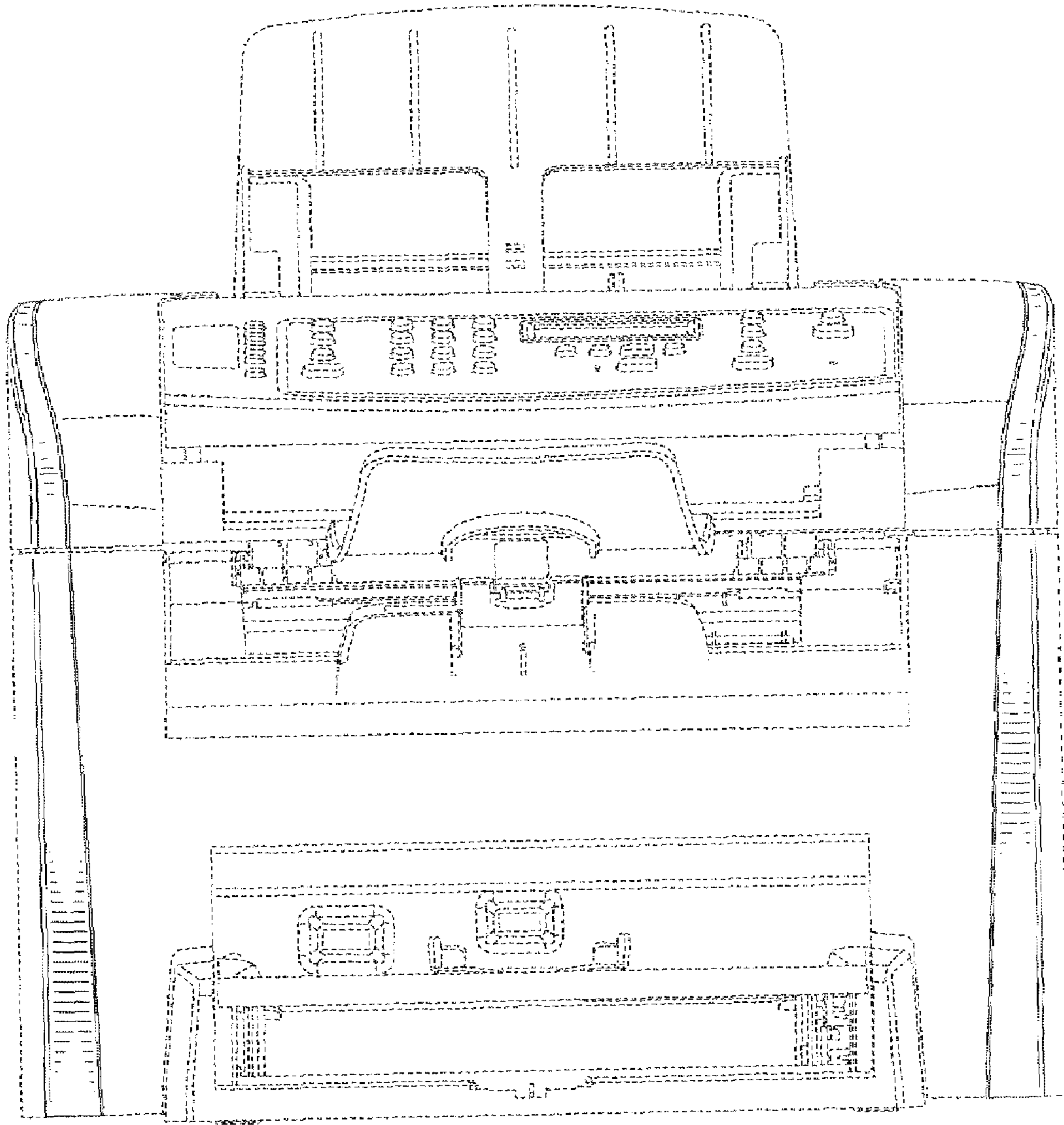

FIG. 2

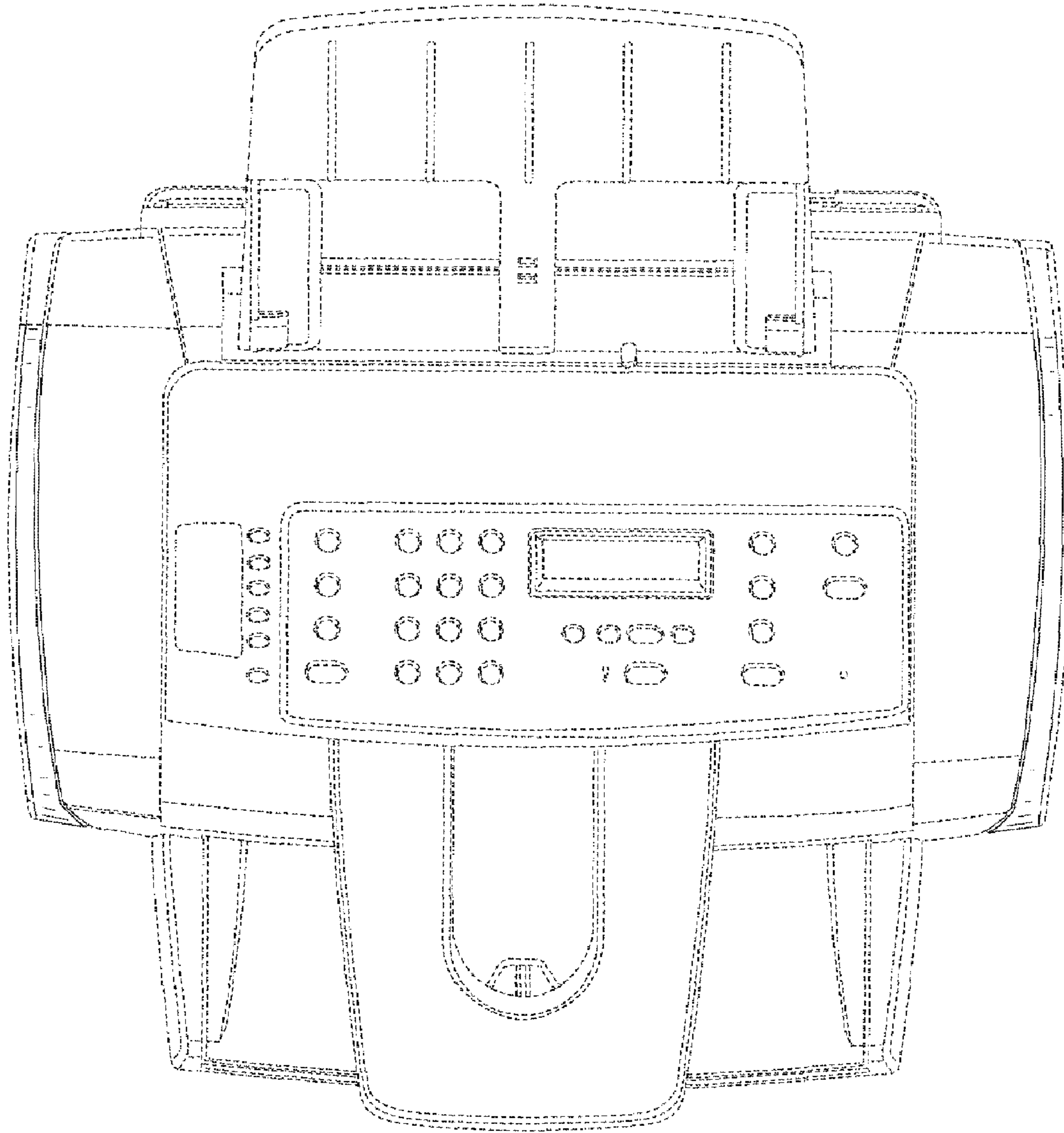

FIG. 3

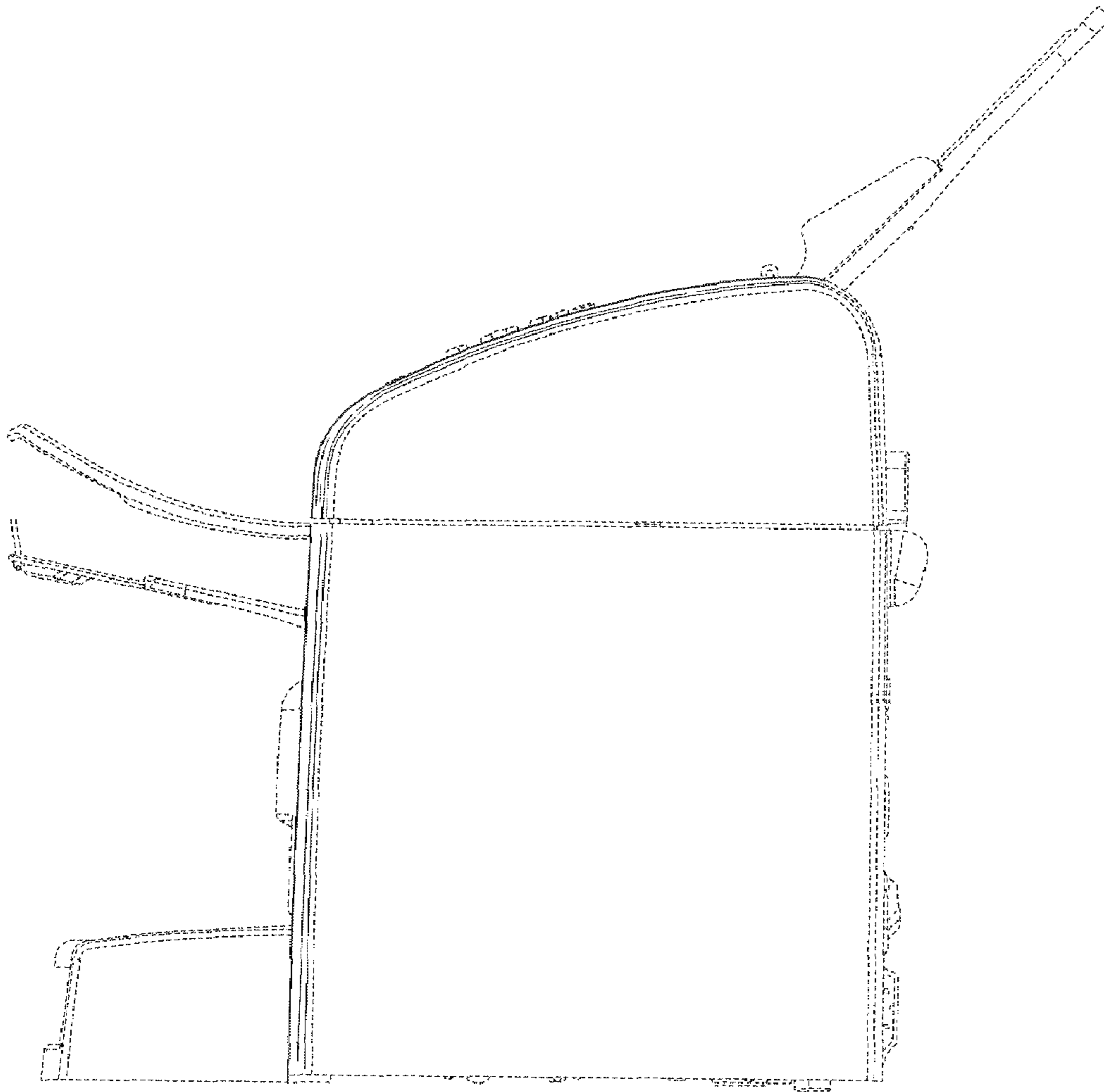

FIG. 4

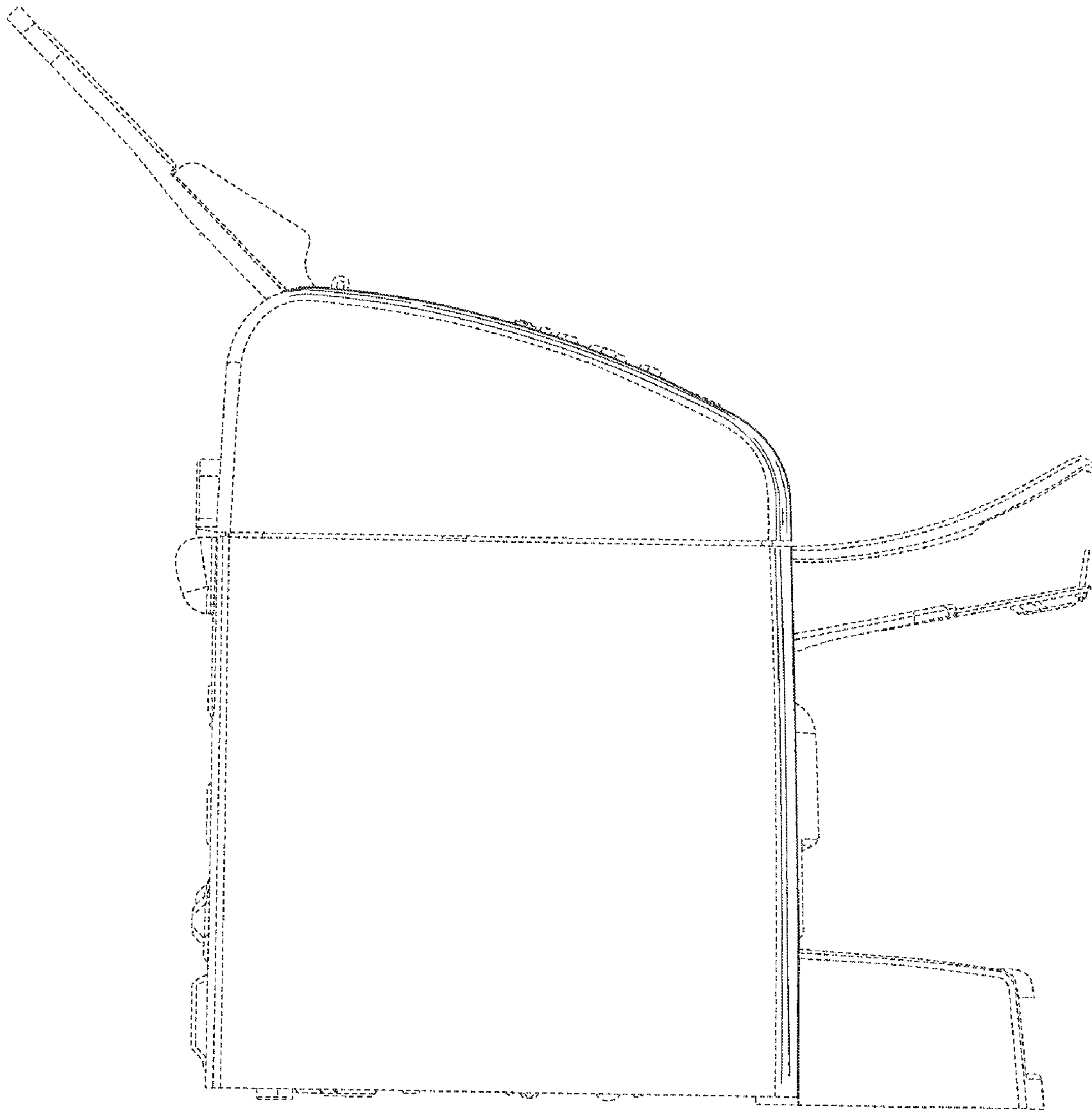

FIG. 5