



US00D554492S

(12) **United States Design Patent**
Bochmann et al.

(10) **Patent No.:** **US D554,492 S**

(45) **Date of Patent:** **** Nov. 6, 2007**

(54) **TACHOMETER PACKAGING**

(75) Inventors: **Cherry Bochmann**, Bay Village, OH (US); **Joe Young**, North Royalton, OH (US); **Bart Ivic**, Columbia Station, OH (US); **Alex Shaland**, Lyndhurst, OH (US); **Robyn Merchant**, Richmond Heights, OH (US)

(73) Assignee: **SPX Corporation**, Charlotte, NC (US)

(**) Term: **14 Years**

(21) Appl. No.: **29/269,469**

(22) Filed: **Dec. 1, 2006**

(51) **LOC (8) Cl.** **09-03**

(52) **U.S. Cl.** **D9/415; D9/424**

(58) **Field of Classification Search** D9/414, D9/415, 418, 424, 425, 457; D22/108, 199; 206/461-471, 495, 806, 701-705, 769-776
See application file for complete search history.

(56) **References Cited**

U.S. PATENT DOCUMENTS

D266,742 S *	11/1982	Claxton	D9/415
D396,632 S *	8/1998	Lee	D9/415
D400,096 S *	10/1998	Lee	D9/415
D405,688 S *	2/1999	Lee et al.	D9/415
D408,280 S *	4/1999	Manley et al.	D9/415
D431,459 S *	10/2000	Lee	D9/415
D431,461 S *	10/2000	Glassman	D9/415
D432,411 S *	10/2000	Pirro et al.	D9/415

D454,783 S *	3/2002	Pirro et al.	D9/415
6,615,986 B2 *	9/2003	Pirro et al.	206/704
D480,964 S *	10/2003	Lee	D9/415
D496,268 S *	9/2004	Stamm et al.	D9/415
D513,976 S *	1/2006	Milan	D9/415

* cited by examiner

Primary Examiner—Louis S. Zarfes

Assistant Examiner—Susan E Krakower

(74) *Attorney, Agent, or Firm*—Baker & Hostetler LLP

(57) **CLAIM**

The ornamental design for a tachometer packaging, as shown and described.

DESCRIPTION

FIG. 1 is a perspective view of the of the tachometer packaging, particularly showing the inventive design thereof;

FIG. 2 is a front view thereof;

FIG. 3 is a rear view thereof;

FIG. 4 is a left side view thereof;

FIG. 5 is a right side view thereof;

FIG. 6 is a top view thereof; and,

FIG. 7 is a bottom view thereof.

The broken line showing of hanging aperture is included for the purpose of illustrating environmental structure and forms no part of the claimed design.

1 Claim, 4 Drawing Sheets

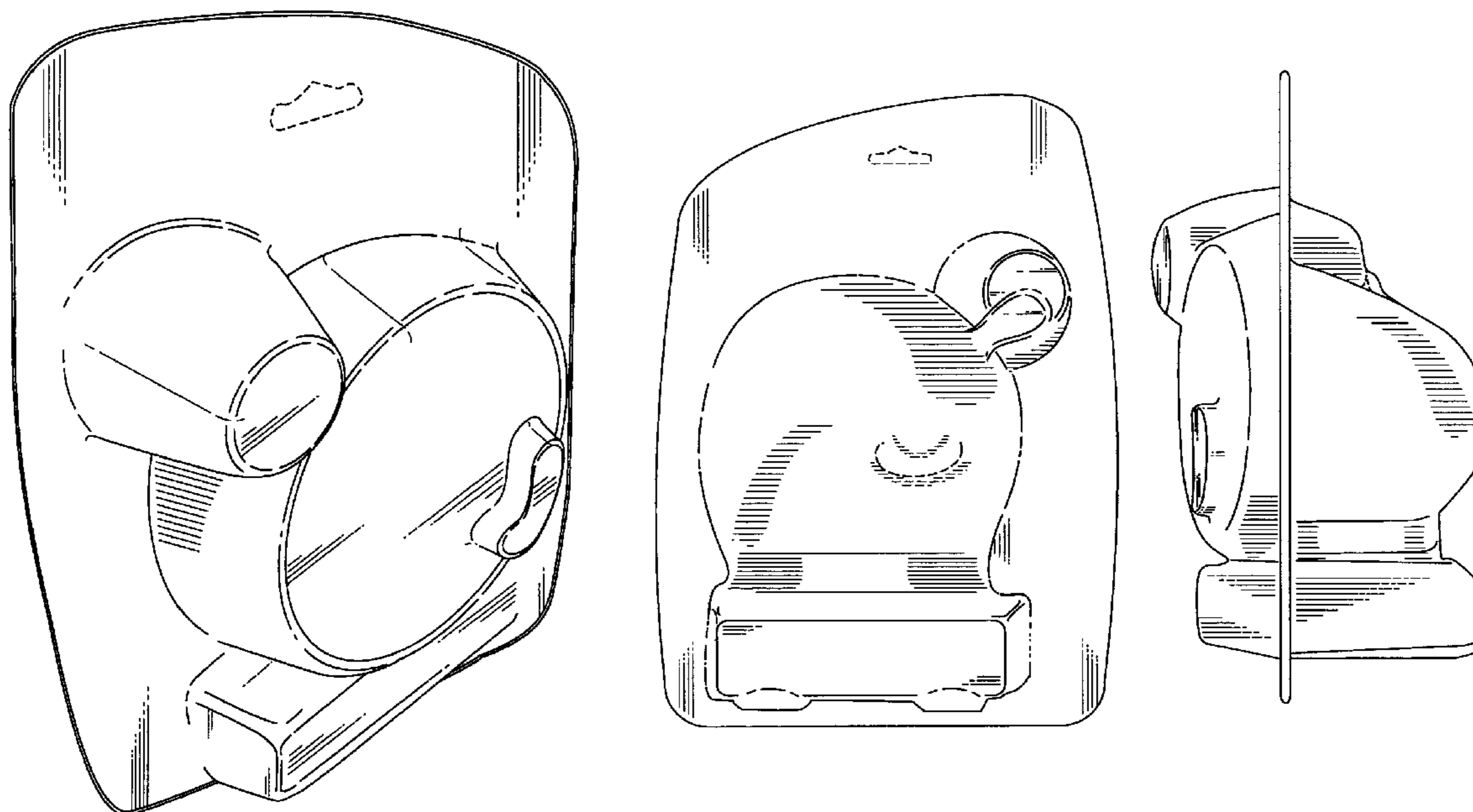

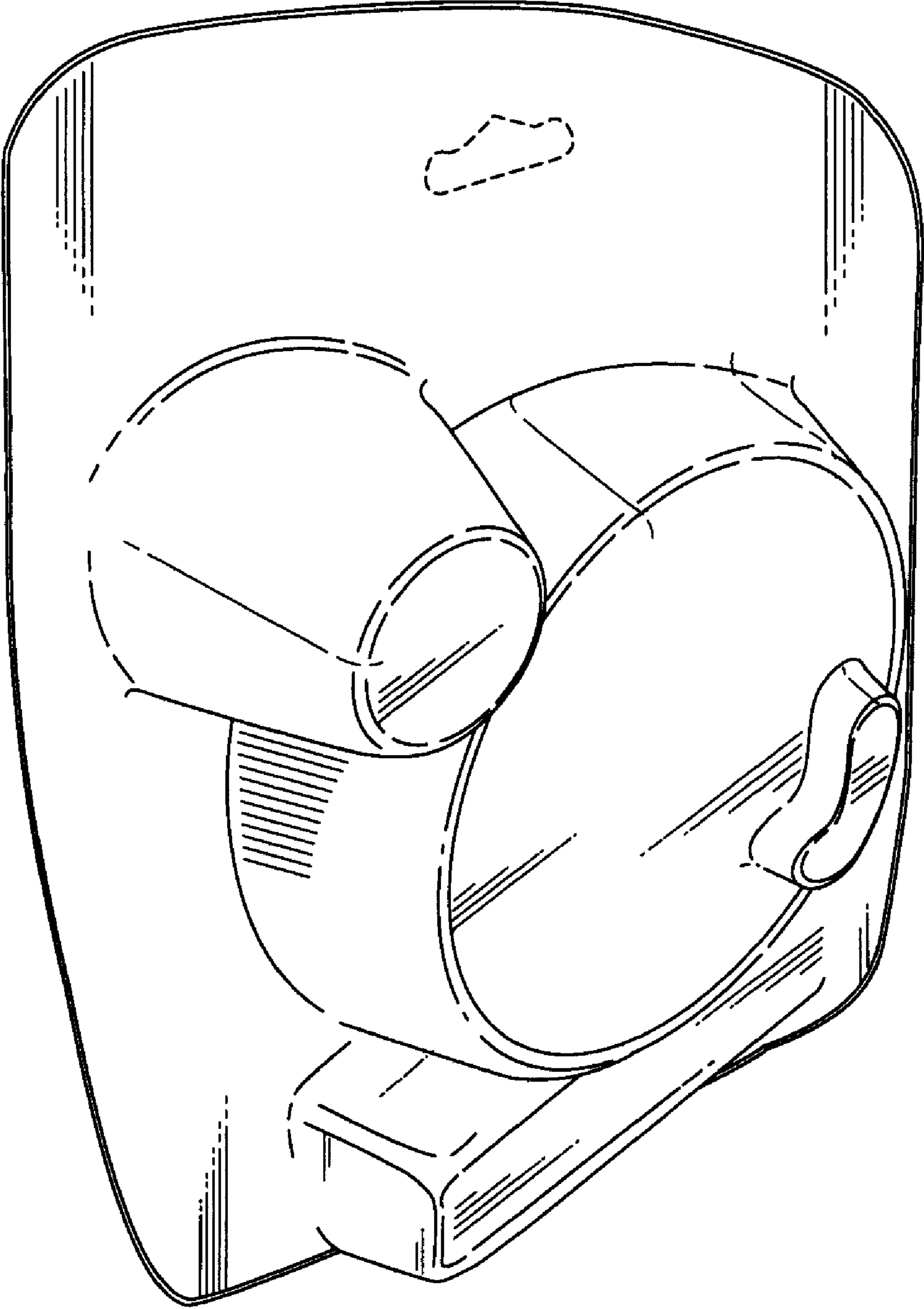

FIG. 1

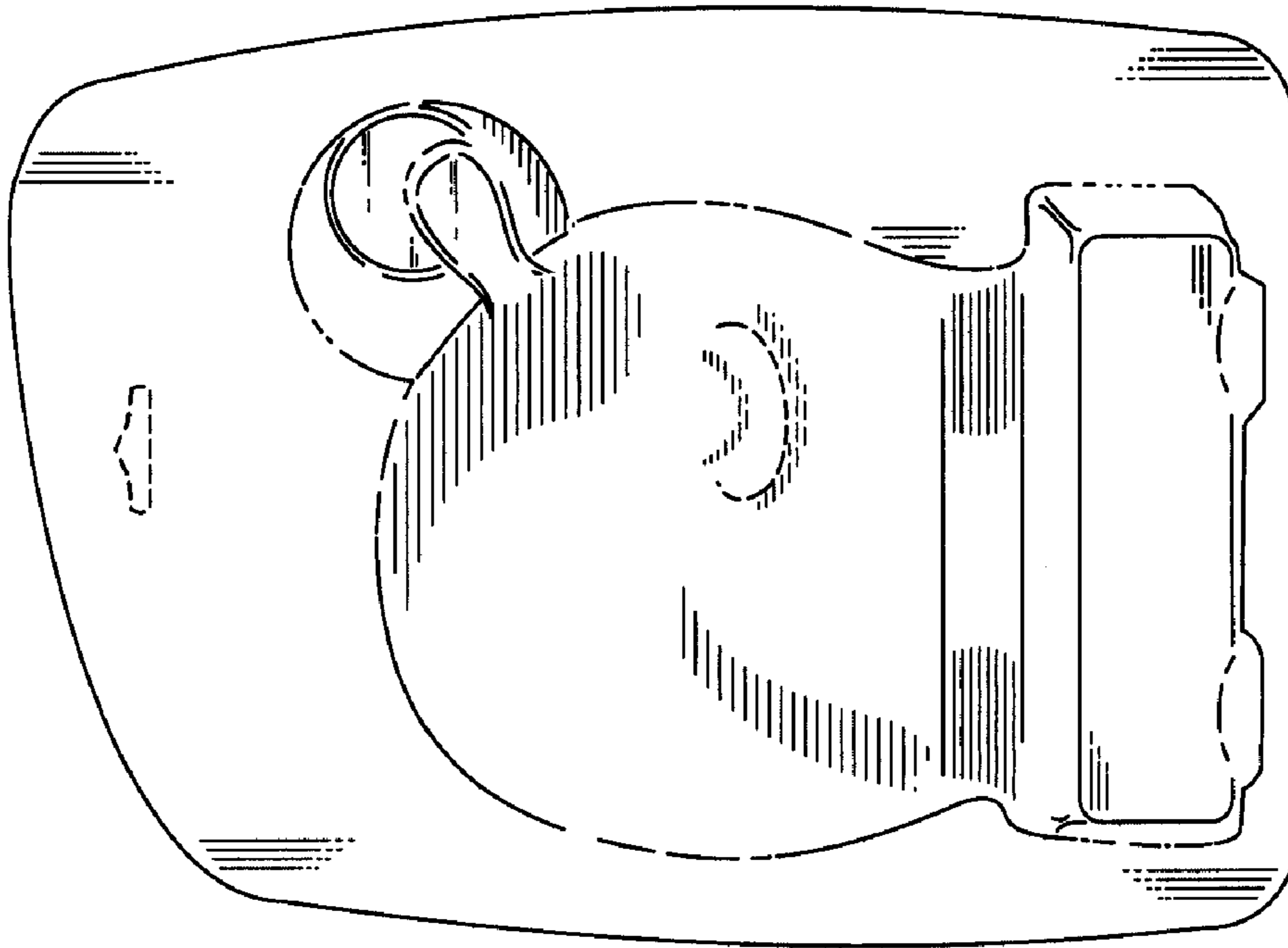

FIG. 3

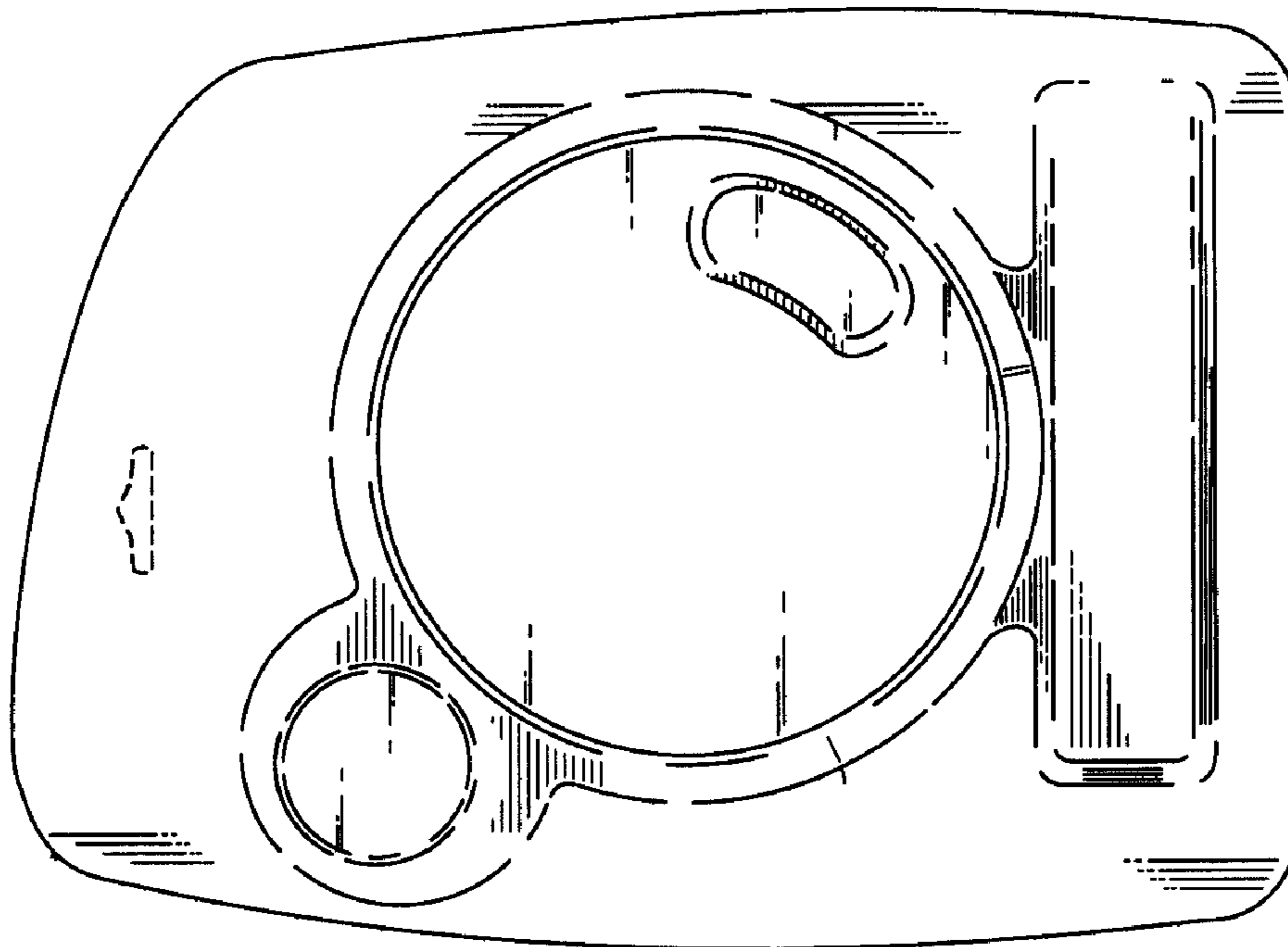

FIG. 2

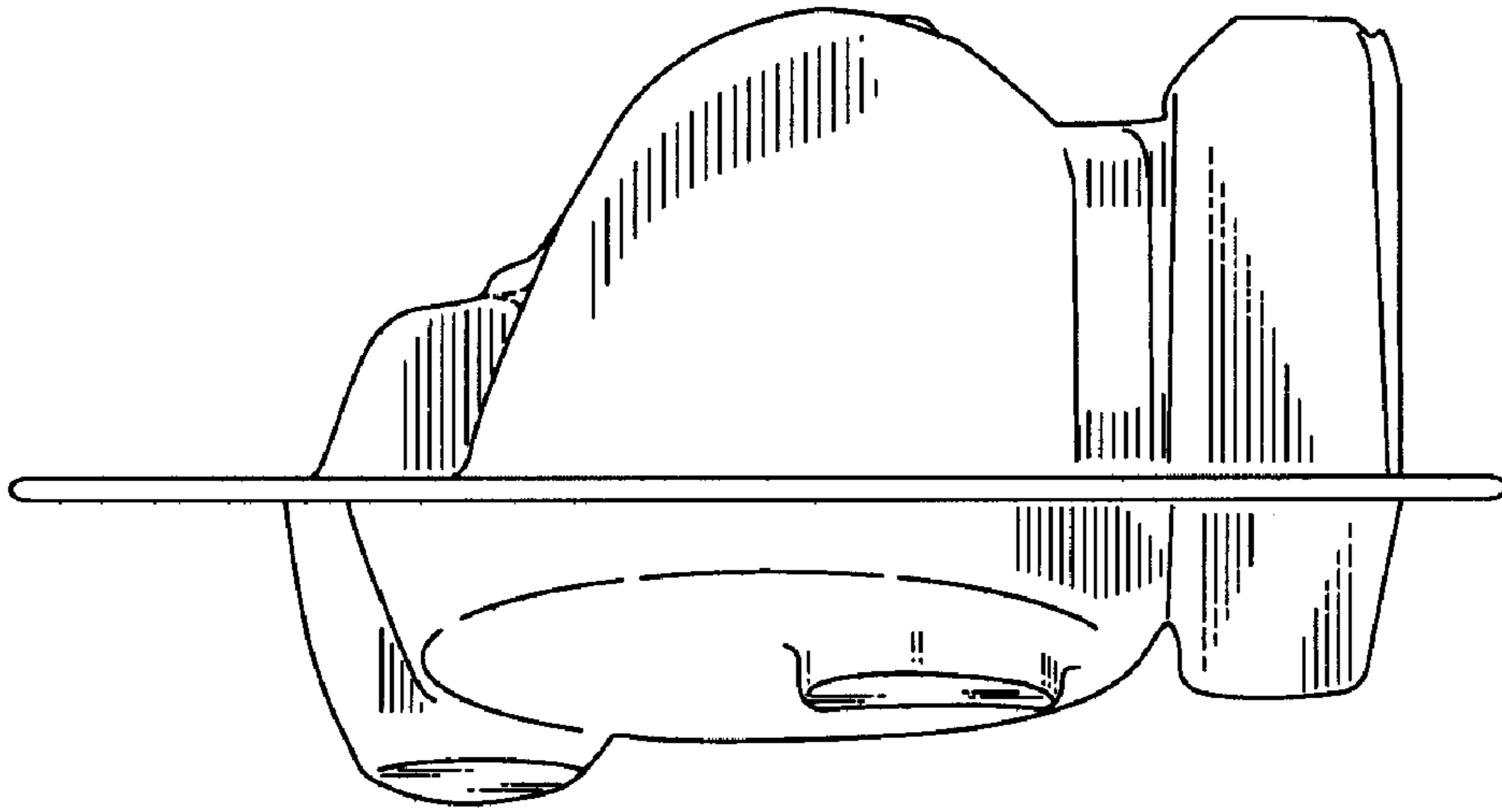

FIG. 5

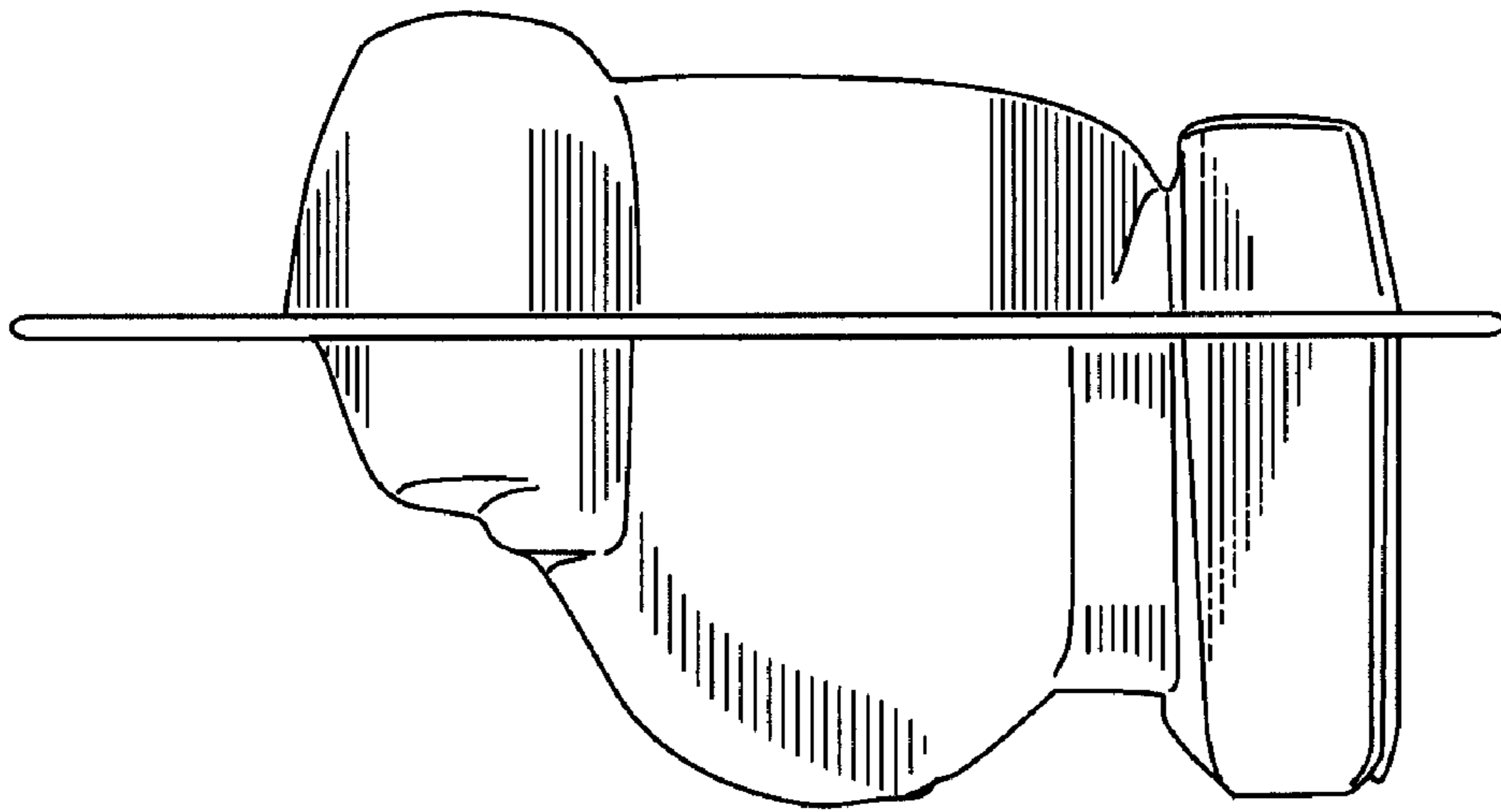

FIG. 4

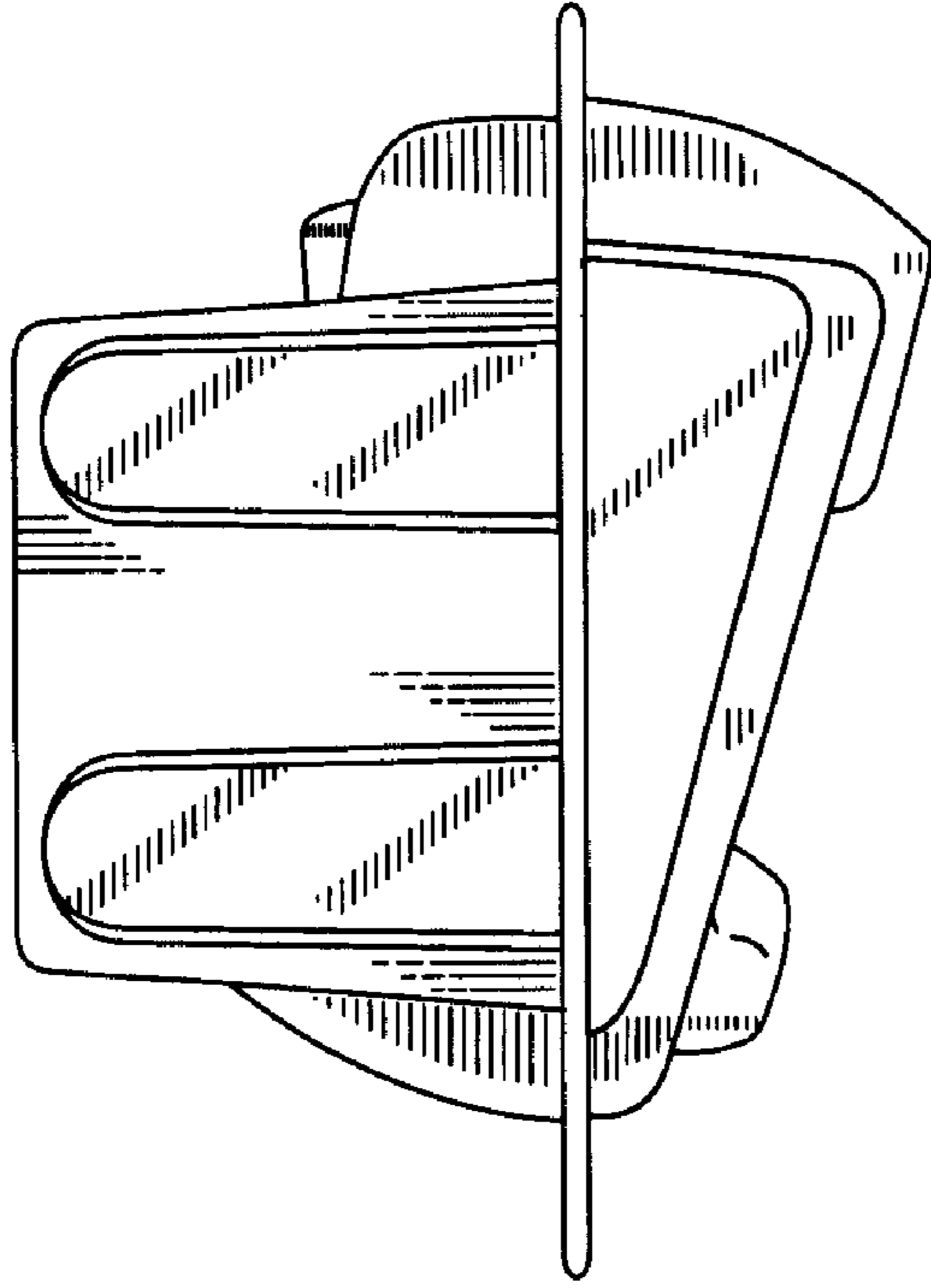

FIG. 7

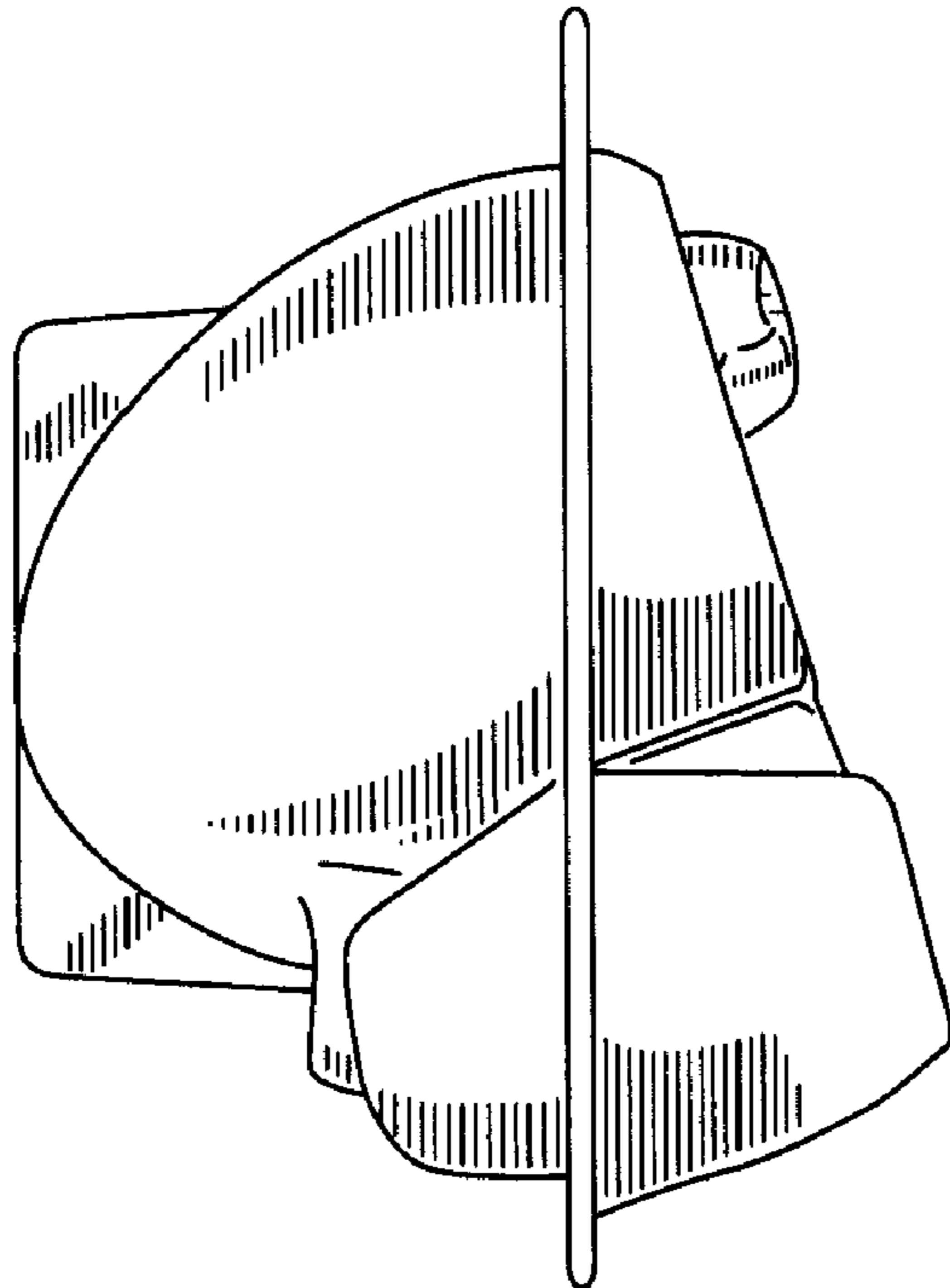

FIG. 6

UNITED STATES PATENT AND TRADEMARK OFFICE
CERTIFICATE OF CORRECTION

PATENT NO. : Des. 554,492 S
APPLICATION NO. : 29/269469
DATED : November 6, 2007
INVENTOR(S) : Cherry Bochmann et al.

Page 1 of 1

It is certified that error appears in the above-identified patent and that said Letters Patent is hereby corrected as shown below:

Title Page

Item (57), Description:

FIG. 1, please replace "of the of the tachometer" with --of the tachometer--.

Signed and Sealed this

Twenty-sixth Day of February, 2008

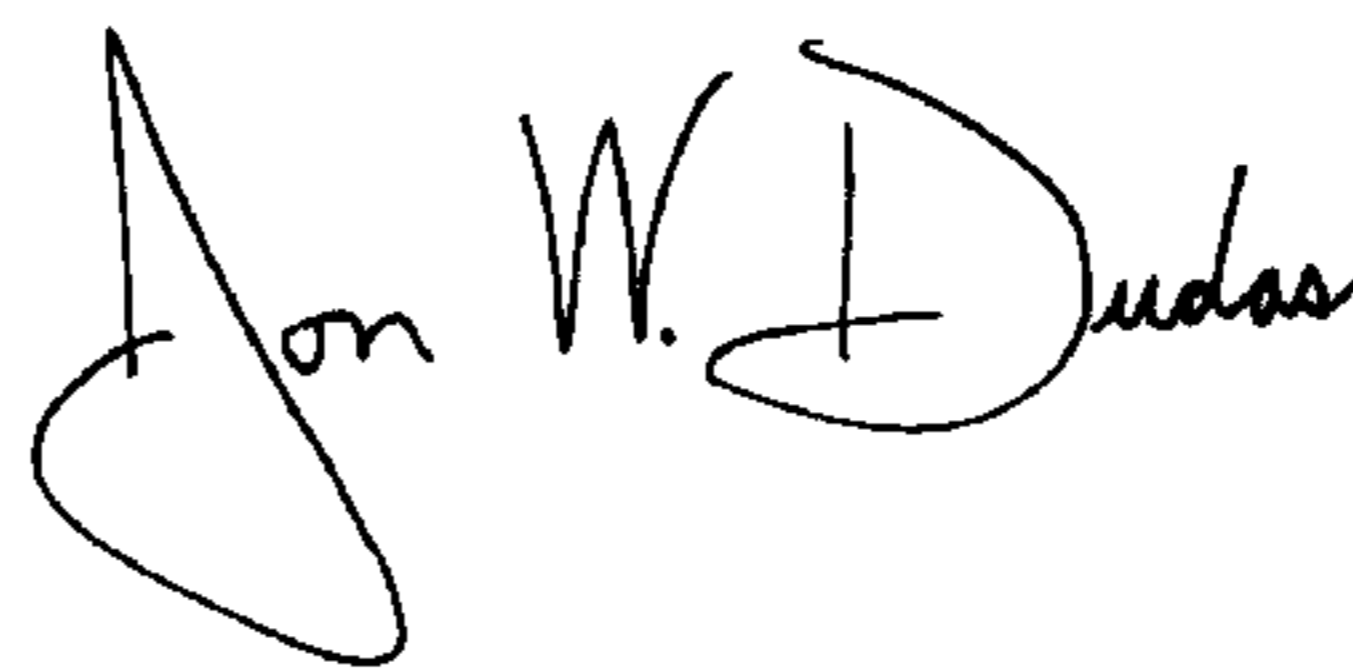
A handwritten signature in black ink that reads "Jon W. Dudas". The signature is written in a cursive style with a large, looped initial "J".

JON W. DUDAS

Director of the United States Patent and Trademark Office