



US00D554449S

(12) **United States Design Patent** (10) **Patent No.:** **US D554,449 S**  
**Stewart** (45) **Date of Patent:** **\*\* Nov. 6, 2007**

(54) **TRUNCATED SCOOP**

(75) Inventor: **Joshua R. Stewart**, Seattle, WA (US)

(73) Assignee: **Chef'n Corporation**, Seattle, WA (US)

(\*\*) Term: **14 Years**

(21) Appl. No.: **29/249,314**

(22) Filed: **Sep. 29, 2006**

(51) **LOC (8) Cl.** ..... **07-02**

(52) **U.S. Cl.** ..... **D7/691; D10/46.3**

(58) **Field of Classification Search** ..... D7/680-696,  
D7/393, 395, 401.2, 653-664; D10/46.2,  
D10/46.3; 30/324-328; 73/426-429; 294/1.1,  
294/55

See application file for complete search history.

(56) **References Cited**

**U.S. PATENT DOCUMENTS**

1,708,456	A *	4/1929	Tunick	.....	30/326
2,034,733	A *	3/1936	Wilkins	.....	73/426
2,259,504	A *	10/1941	Wilson et al.	.....	73/426
D396,011	S *	7/1998	Henriksson	.....	D10/46.2
D404,662	S *	1/1999	Prindle	.....	D10/46.2
D493,679	S *	8/2004	Metzger-Boehringer	.....	D7/692
6,974,056	B2 *	12/2005	Rea	.....	73/426

\* cited by examiner

*Primary Examiner*—Terry A. Wallace

(74) *Attorney, Agent, or Firm*—Seed IP Law Group PLLC

(57) **CLAIM**

The ornamental design for a truncated scoop, as shown and described.

**DESCRIPTION**

FIG. 1 is an isometric view of a truncated scoop showing my new design;

FIG. 2 is an isometric view thereof in an alternate configuration;

FIG. 3 is an isometric view thereof in a closed position;

FIG. 4 is a rear elevation view thereof;

FIG. 5 is a right side view thereof;

FIG. 6 is a bottom plan view thereof;

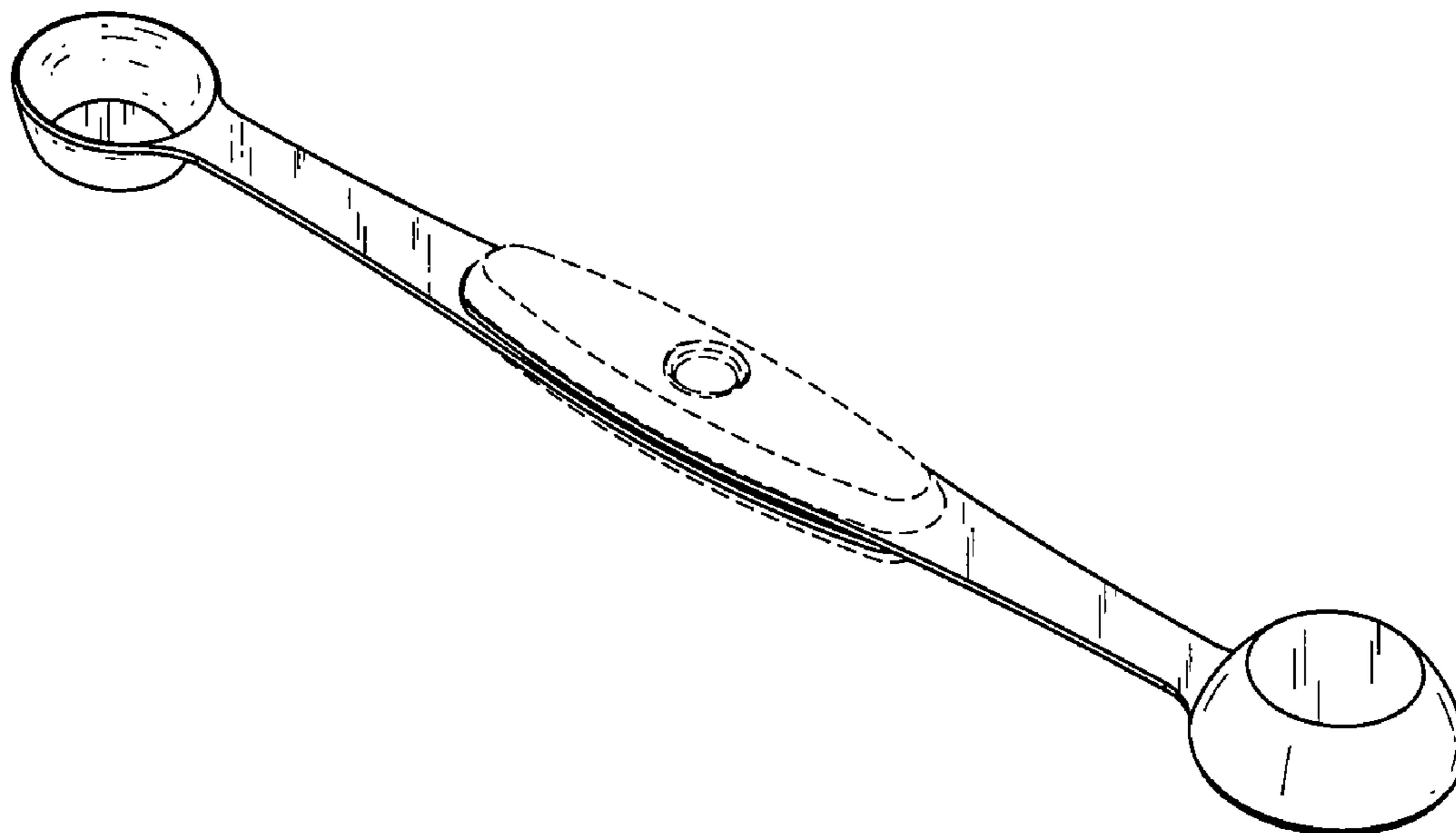
FIG. 7 is a front elevation view thereof;

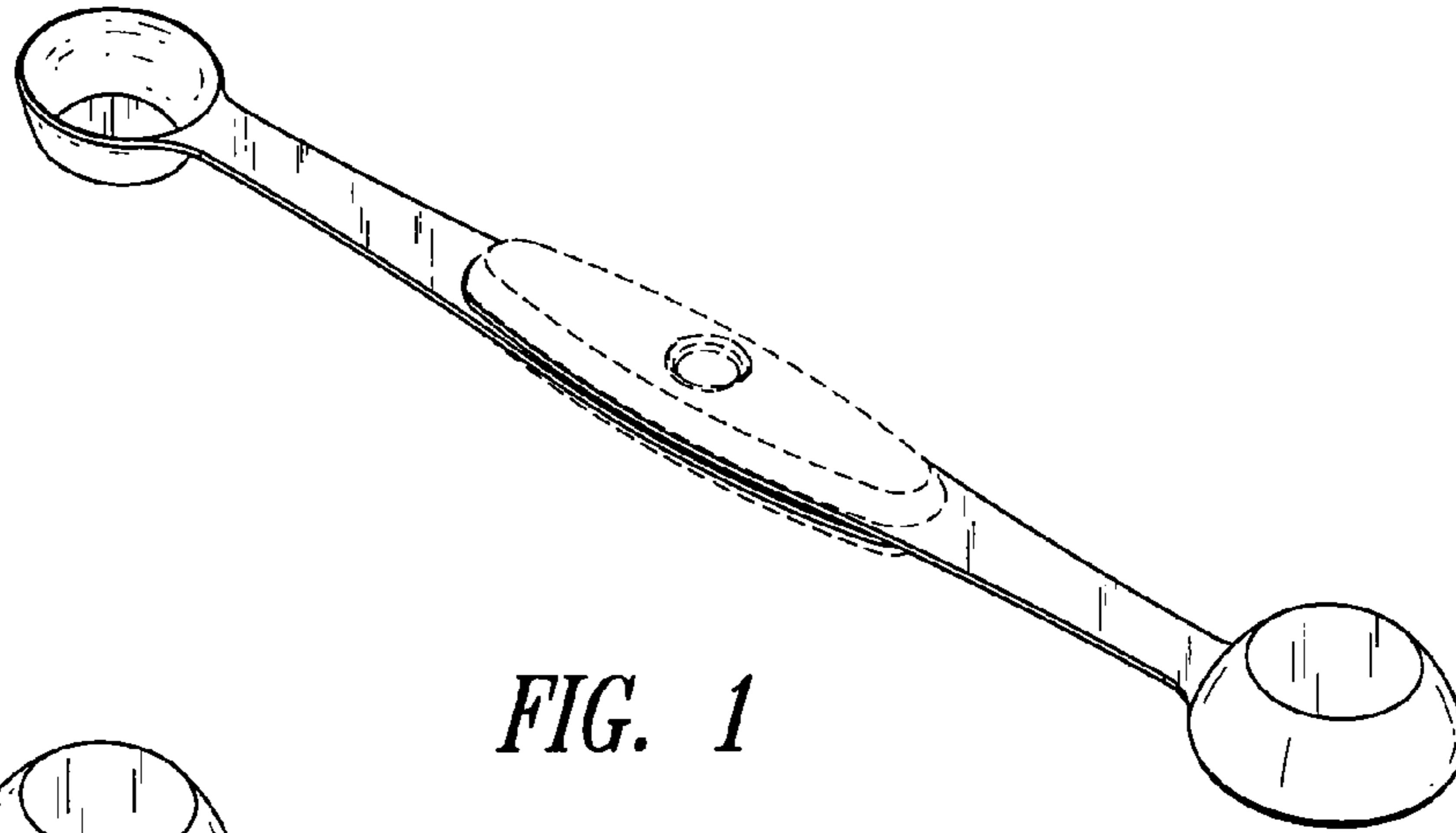
FIG. 8 is a left side view thereof; and,

FIG. 9 is a top plan view thereof.

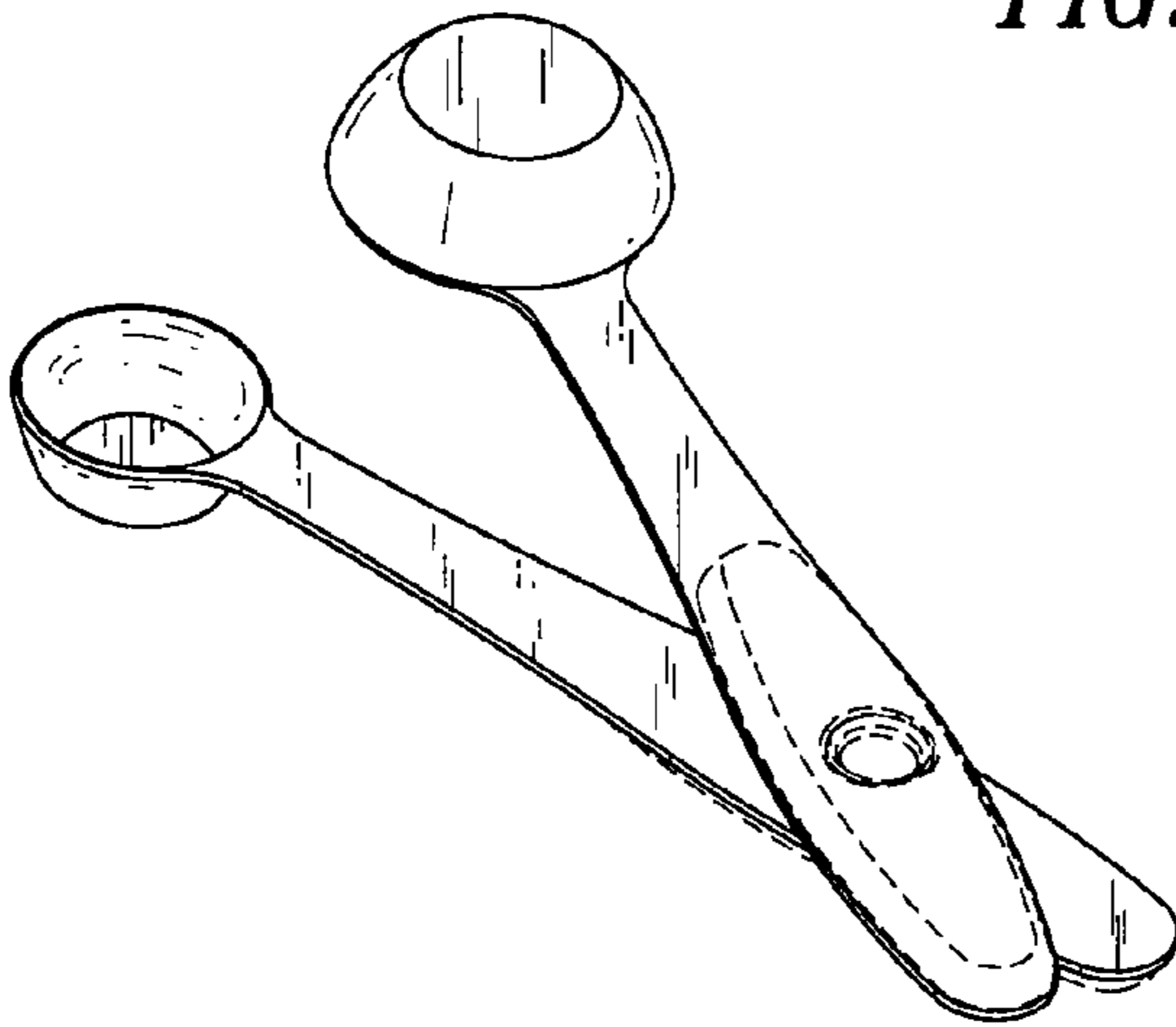
The broken lines are for illustrative purposes only and form no part of the claimed design.

**1 Claim, 3 Drawing Sheets**

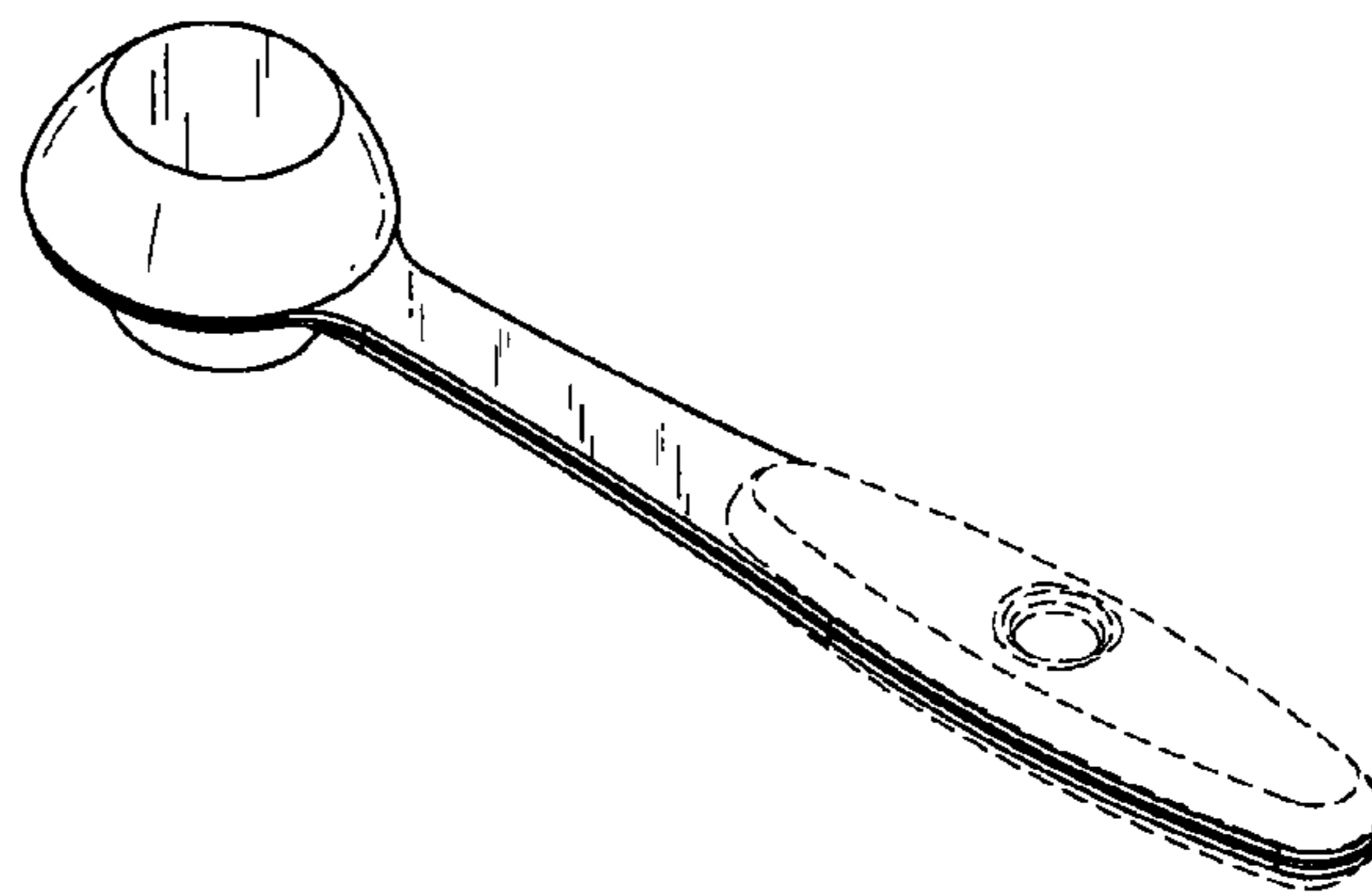




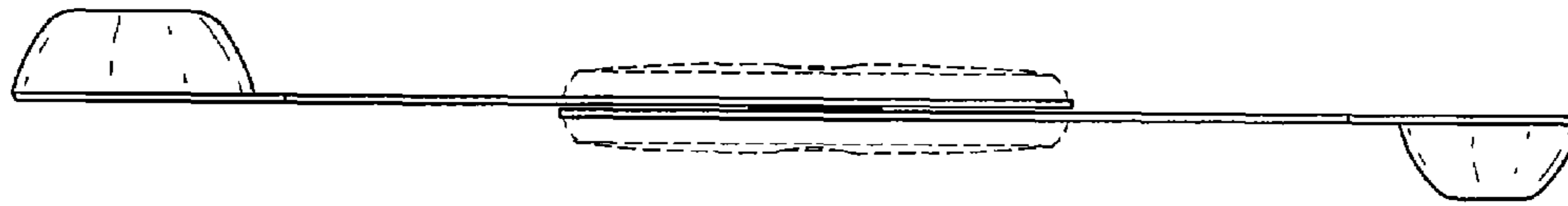
*FIG. 1*



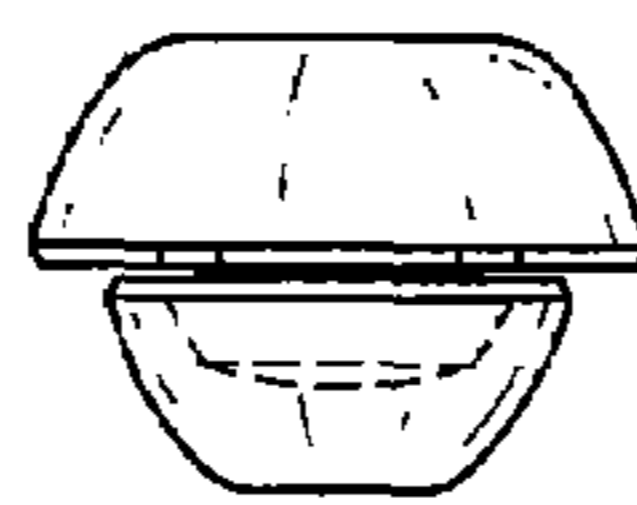
*FIG. 2*



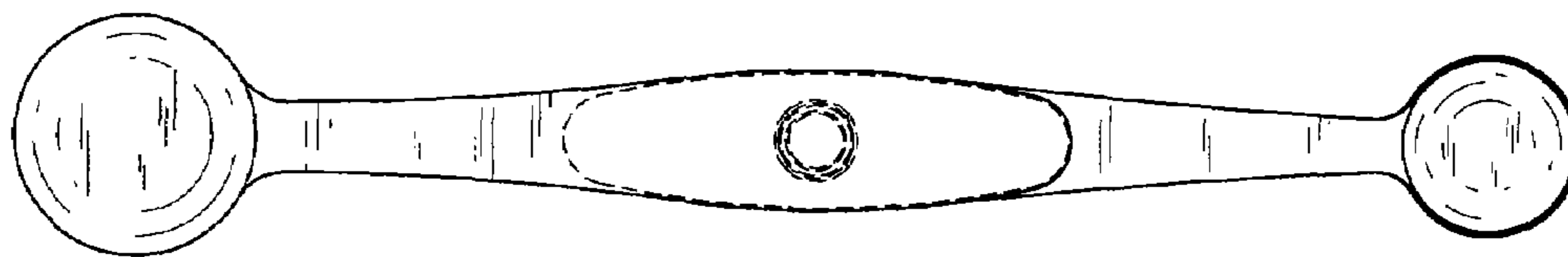
*FIG. 3*



*FIG. 4*



*FIG. 5*



*FIG. 6*

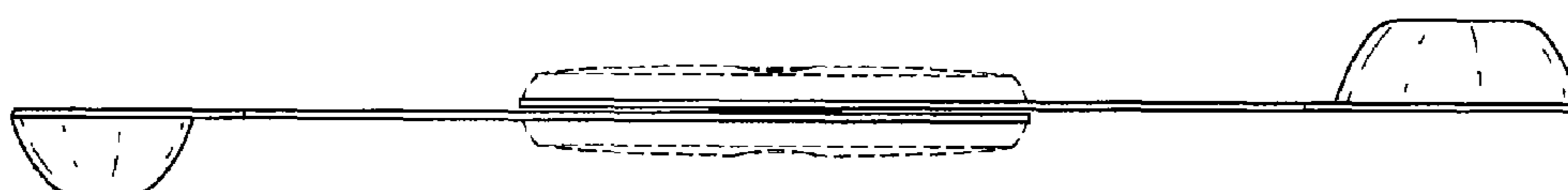


FIG. 7

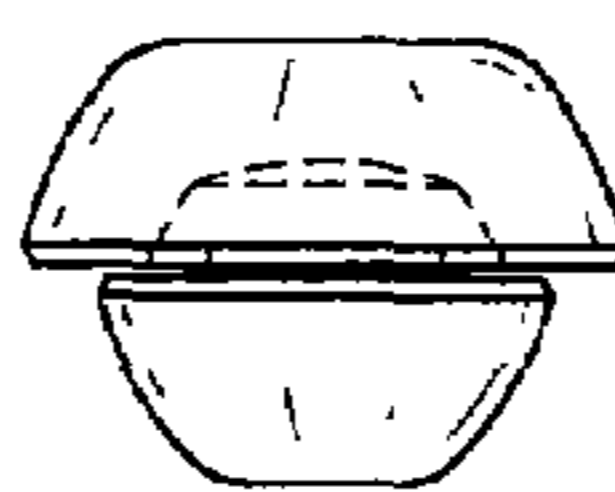


FIG. 8

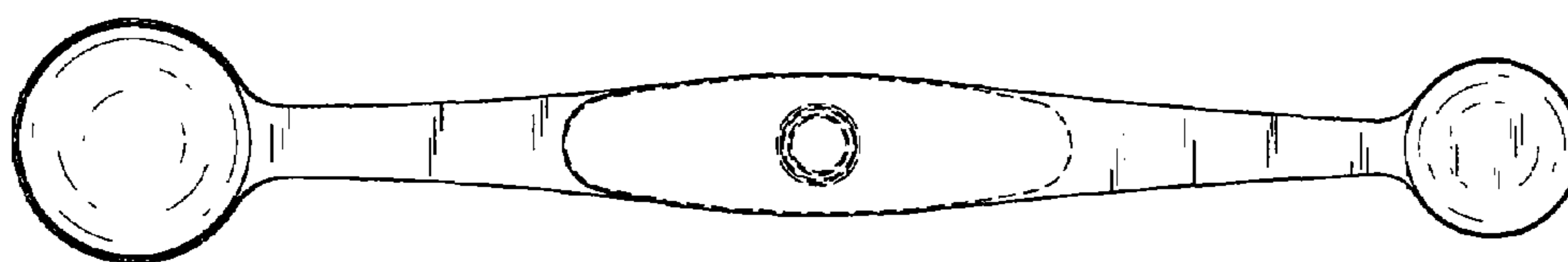


FIG. 9