



US00D554268S

(12) **United States Design Patent**  
**Harding**

(10) **Patent No.:** **US D554,268 S**

(45) **Date of Patent:** **\*\* Oct. 30, 2007**

(54) **MEMORY FOAM BACK BRACE**

(76) Inventor: **Damian C. Harding**, 4303 Abigail Dr.,  
Killeen, TX (US) 76549

(\*\*) Term: **14 Years**

(21) Appl. No.: **29/269,032**

(22) Filed: **Nov. 17, 2006**

(51) **LOC (8) Cl.** ..... **24-01**

(52) **U.S. Cl.** ..... **D24/190**

(58) **Field of Classification Search** ..... D24/189,  
D24/190-192, 200-215; 607/98, 108-111;  
D2/897, 905, 909-914; 602/14, 19, 61, 62;  
2/171, 181, 209, 311-313, 321, 338; 128/68,  
128/78-112, 117, 120, 132, 149-151, 153-156,  
128/876

See application file for complete search history.

(56) **References Cited**

**U.S. PATENT DOCUMENTS**

D222,511 S *	10/1971	Ventre .....	D21/805
D281,005 S *	10/1985	Larsen .....	D21/694
4,572,167 A	2/1986	Brunswick	
4,782,535 A *	11/1988	Yewer et al. ....	2/321
4,907,576 A	3/1990	Curlee	
4,964,401 A *	10/1990	Taigen .....	482/93
4,991,573 A	2/1991	Miller	
5,070,866 A *	12/1991	Alexander et al. ....	602/19
5,086,758 A *	2/1992	Schiek et al. ....	602/19
D328,792 S *	8/1992	Salmon et al. ....	D24/207
5,147,261 A	9/1992	Smith et al.	
5,316,022 A *	5/1994	Schiek, Sr. ....	128/876
D352,114 S *	11/1994	Nicholson .....	D24/190

5,407,422 A *	4/1995	Matthijs et al. ....	602/19
D358,215 S *	5/1995	Reed .....	D24/190
5,447,498 A *	9/1995	Watson .....	602/19
D368,332 S *	3/1996	Chiang .....	D29/121.1
D375,823 S *	11/1996	Bleiweis .....	D29/101.5
5,586,969 A	12/1996	Yewer, Jr.	
D408,116 S *	4/1999	Gale .....	D2/627
D422,709 S	4/2000	Caswell	
D500,137 S *	12/2004	Hely .....	D24/190

\* cited by examiner

*Primary Examiner*—Stella M. Reid

*Assistant Examiner*—Susan E Krakower

(74) *Attorney, Agent, or Firm*—Kyle Fletcher

(57) **CLAIM**

The ornamental design for memory foam back brace, as shown and described.

**DESCRIPTION**

FIG. 1 is a rear exterior elevational view of a memory foam back brace showing my new design;

FIG. 2 is a front interior elevational view thereof;

FIG. 3 is a left side elevational view thereof;

FIG. 4 is a right side elevational view thereof;

FIG. 5 is a top plan view thereof; and,

FIG. 6 is an isometric view thereof.

It is understood that the strap on the memory foam back brace is shown broken away for ease of illustration and to indicate indeterminate length.

**1 Claim, 3 Drawing Sheets**

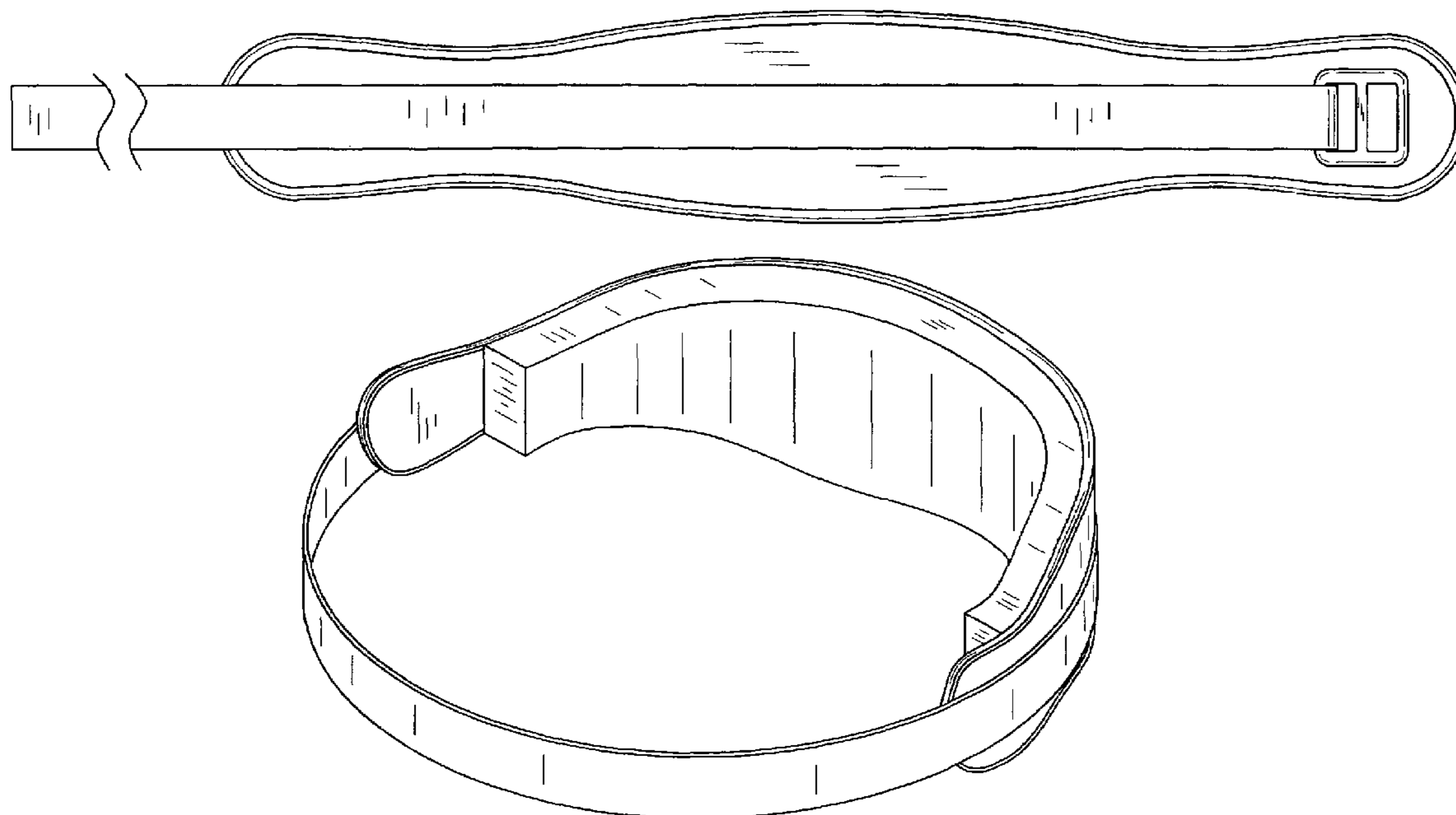

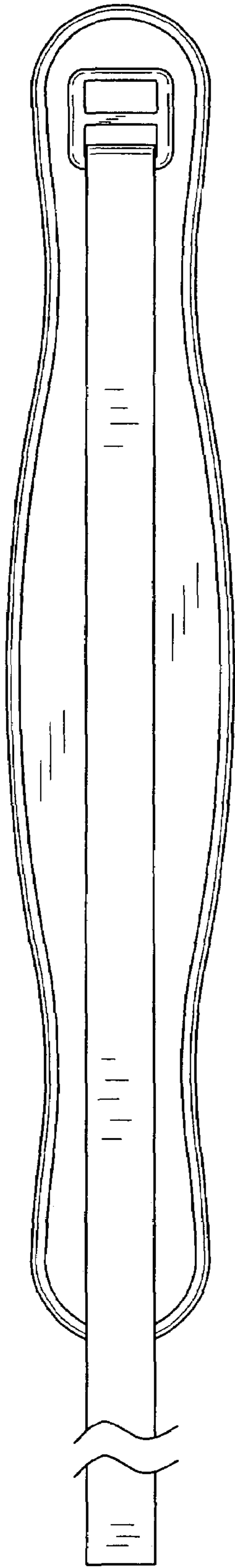

FIG. 1

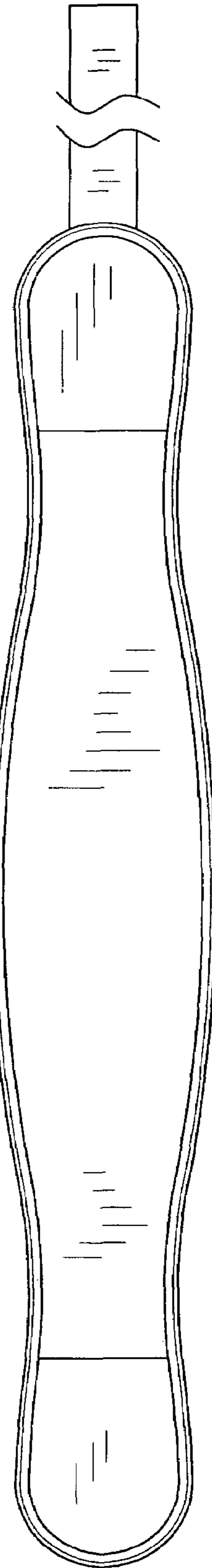

FIG. 2

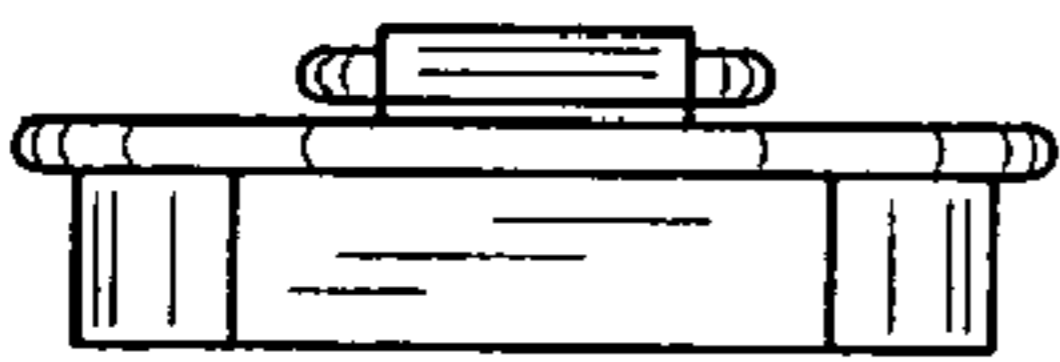

FIG. 3

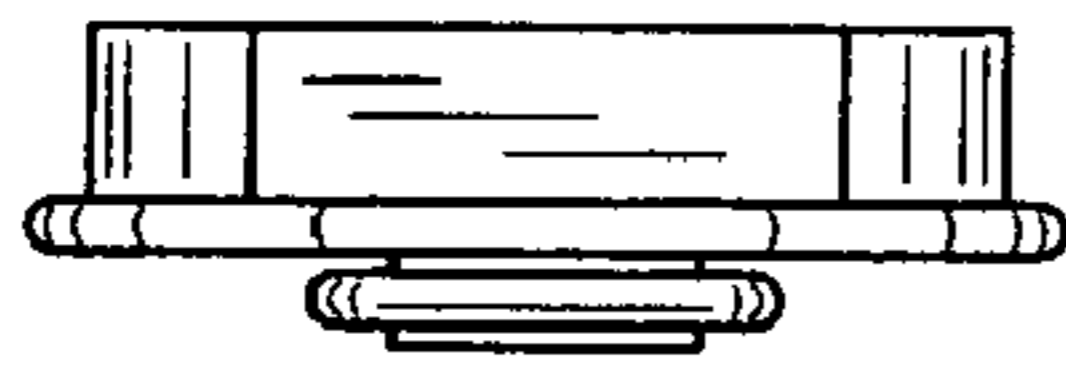

FIG. 4

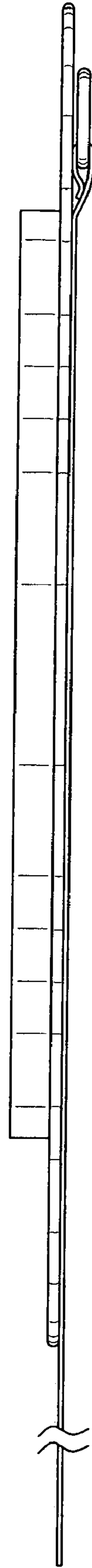

FIG. 5

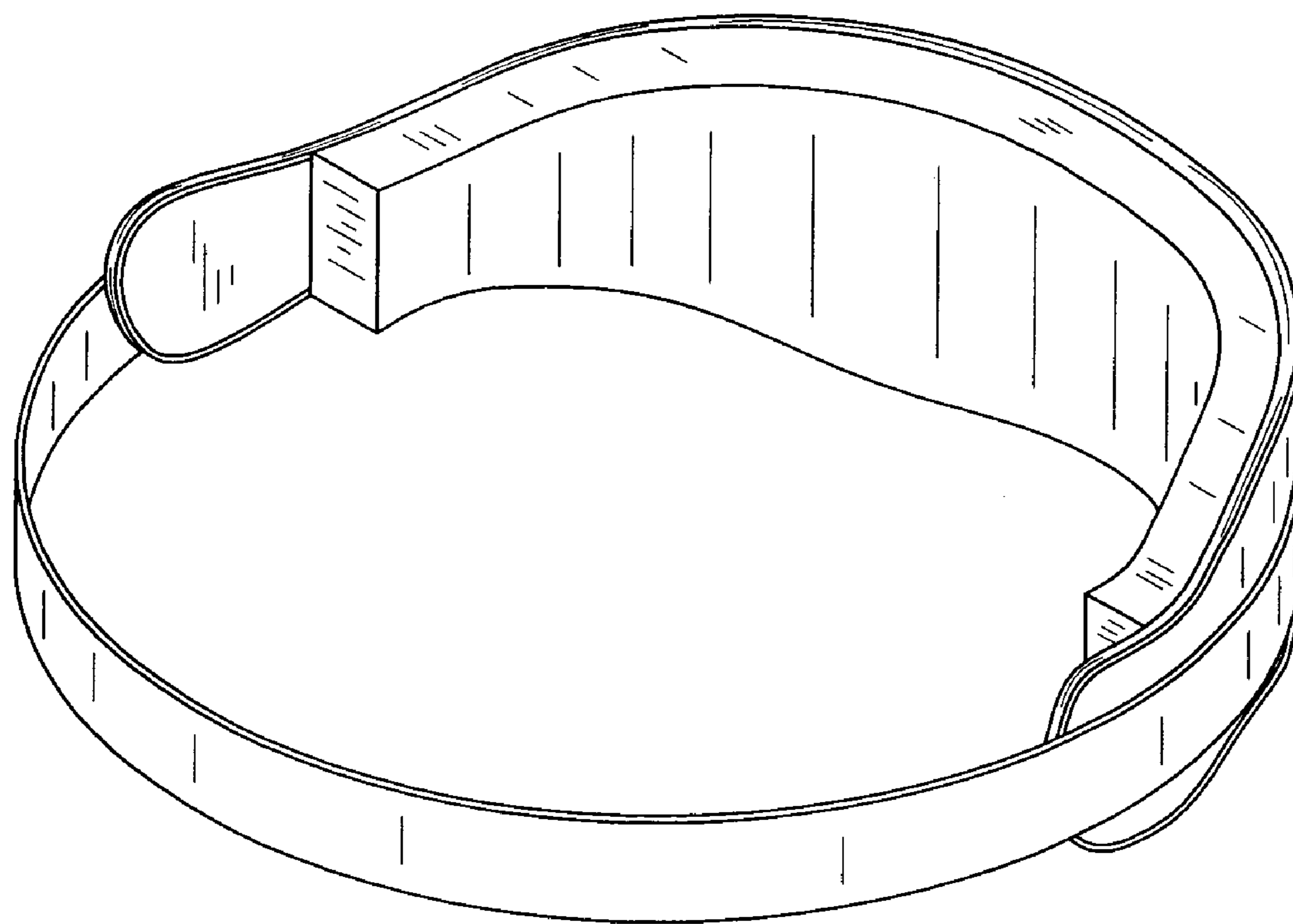

FIG. 6