



US00D554225S

(12) **United States Design Patent**  
**Peterson**

(10) **Patent No.:** **US D554,225 S**

(45) **Date of Patent:** **\*\* Oct. 30, 2007**

(54) **LIFE JACKET**

(75) Inventor: **Leroy L. Peterson**, Omaha, NE (US)

(73) Assignee: **Sportsstuff, Inc.**, Omaha, NE (US)

(\*\*) Term: **14 Years**

(21) Appl. No.: **29/267,308**

(22) Filed: **Oct. 11, 2006**

(51) **LOC (8) Cl.** ..... **29-02**

(52) **U.S. Cl.** ..... **D21/805**

(58) **Field of Classification Search** ..... D21/804,  
D21/805; D29/100, 101.1, 101.4; 2/456,  
2/458, 467, 463; 441/89, 88, 106, 108, 111,  
441/114, 115, 116, 117

See application file for complete search history.

(56) **References Cited**

**U.S. PATENT DOCUMENTS**

1,064,743	A *	6/1913	Kepler	.....	441/115
D232,317	S *	8/1974	Rutland	.....	D21/805
4,884,295	A *	12/1989	Cox	.....	2/467
4,973,277	A *	11/1990	Khanamirian	.....	441/88
4,990,115	A *	2/1991	Vorhauer et al.	.....	441/111
D361,115	S *	8/1995	Lucius	.....	D21/805

D422,666	S *	4/2000	Wagner	.....	D21/805
6,328,618	B1 *	12/2001	Fleischli	.....	441/106
D453,398	S *	2/2002	Masuda	.....	D29/101.4
6,925,652	B2 *	8/2005	Feng	.....	2/2.15

\* cited by examiner

*Primary Examiner*—Janice E. Seeger

*Assistant Examiner*—Zenia I. Bennett

(74) *Attorney, Agent, or Firm*—Sturm & Fix LLP

(57) **CLAIM**

The ornamental design for a life jacket, as shown and described.

**DESCRIPTION**

FIG. 1 is a perspective view of the life jacket showing my new design;

FIG. 2 is a right side elevational view thereof;

FIG. 3 is a left side elevational view thereof;

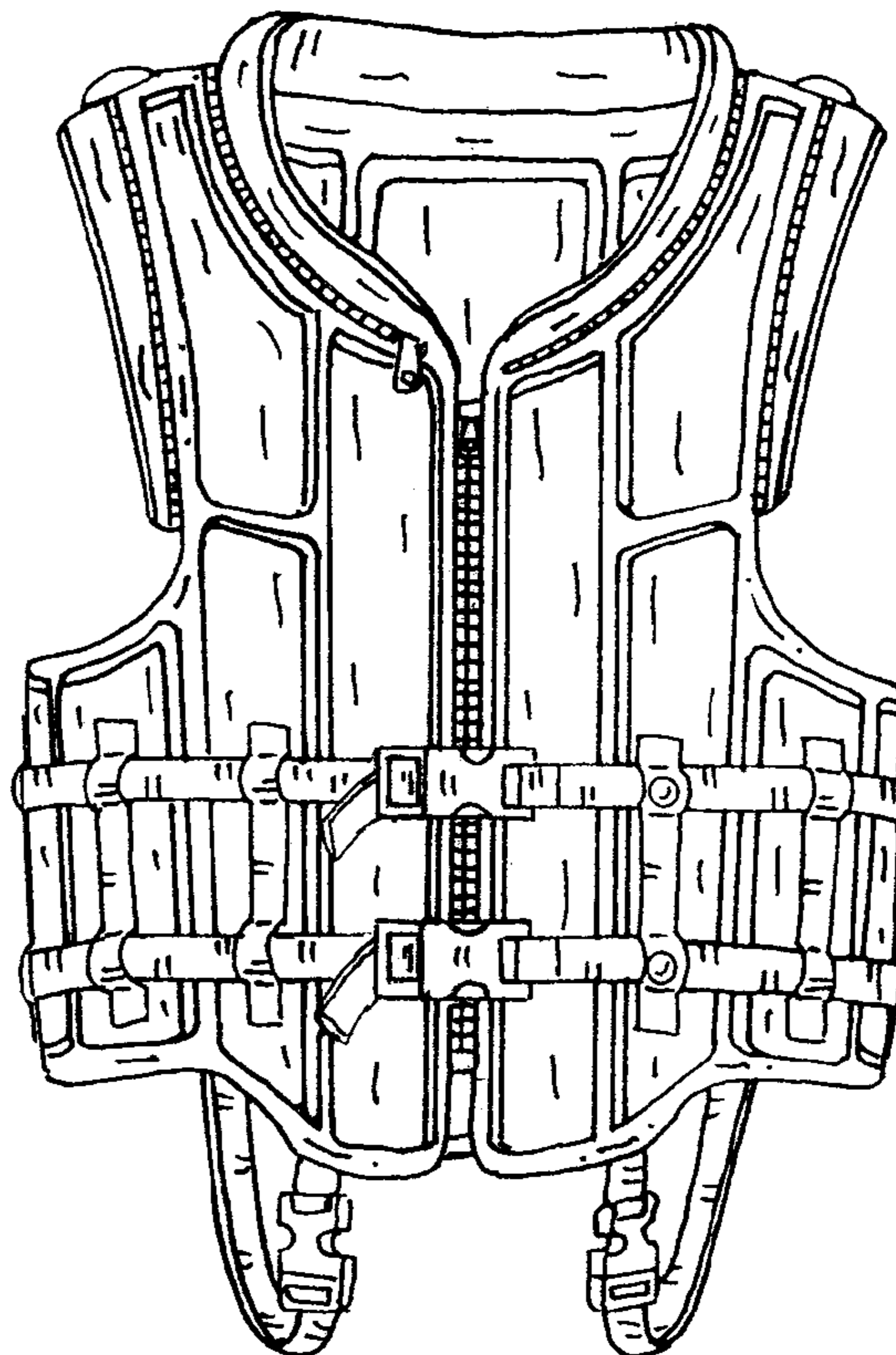
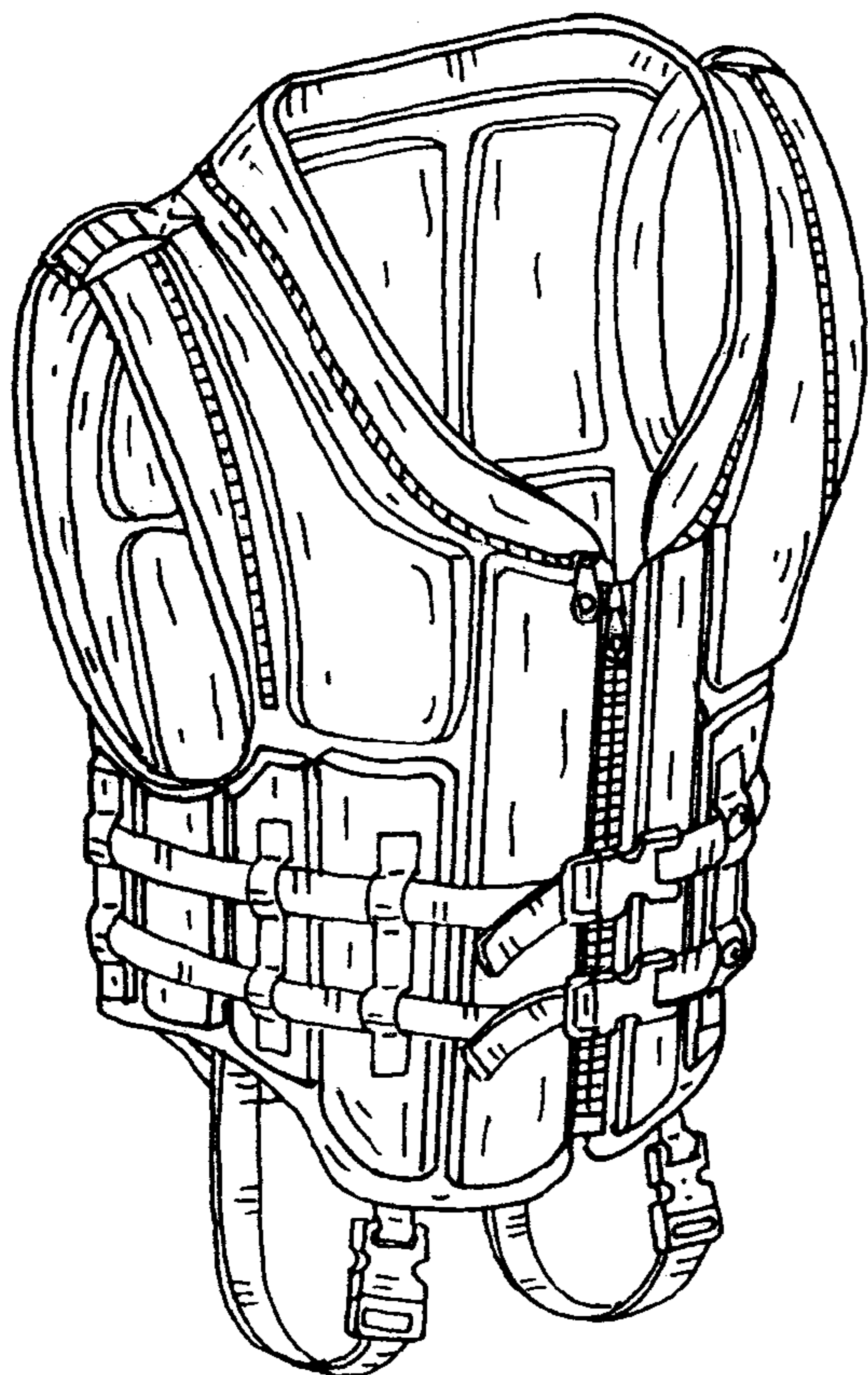
FIG. 4 is a front elevational view thereof;

FIG. 5 is a rear elevational view thereof;

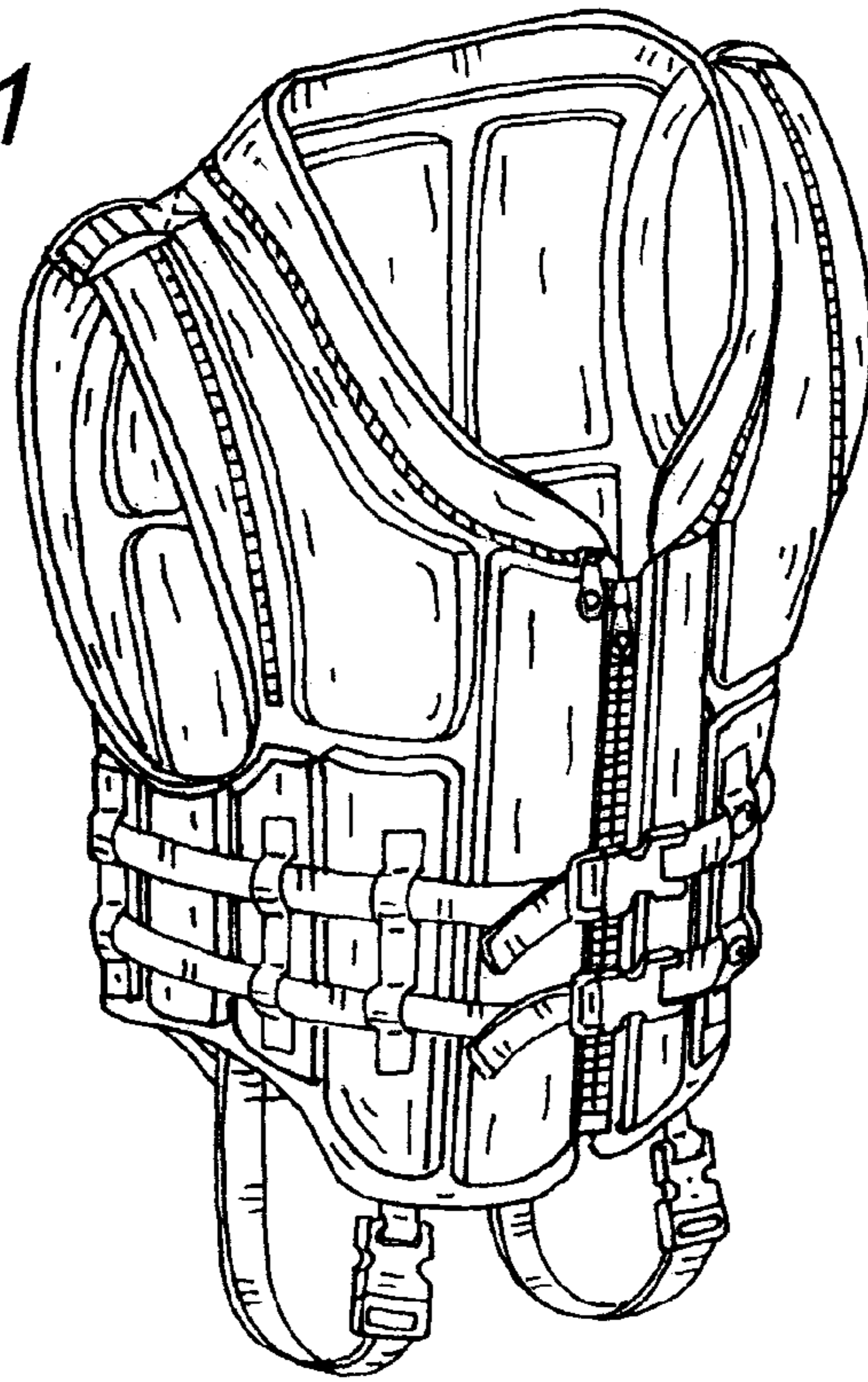
FIG. 6 is a top plan view thereof; and,

FIG. 7 is a bottom plan view thereof.

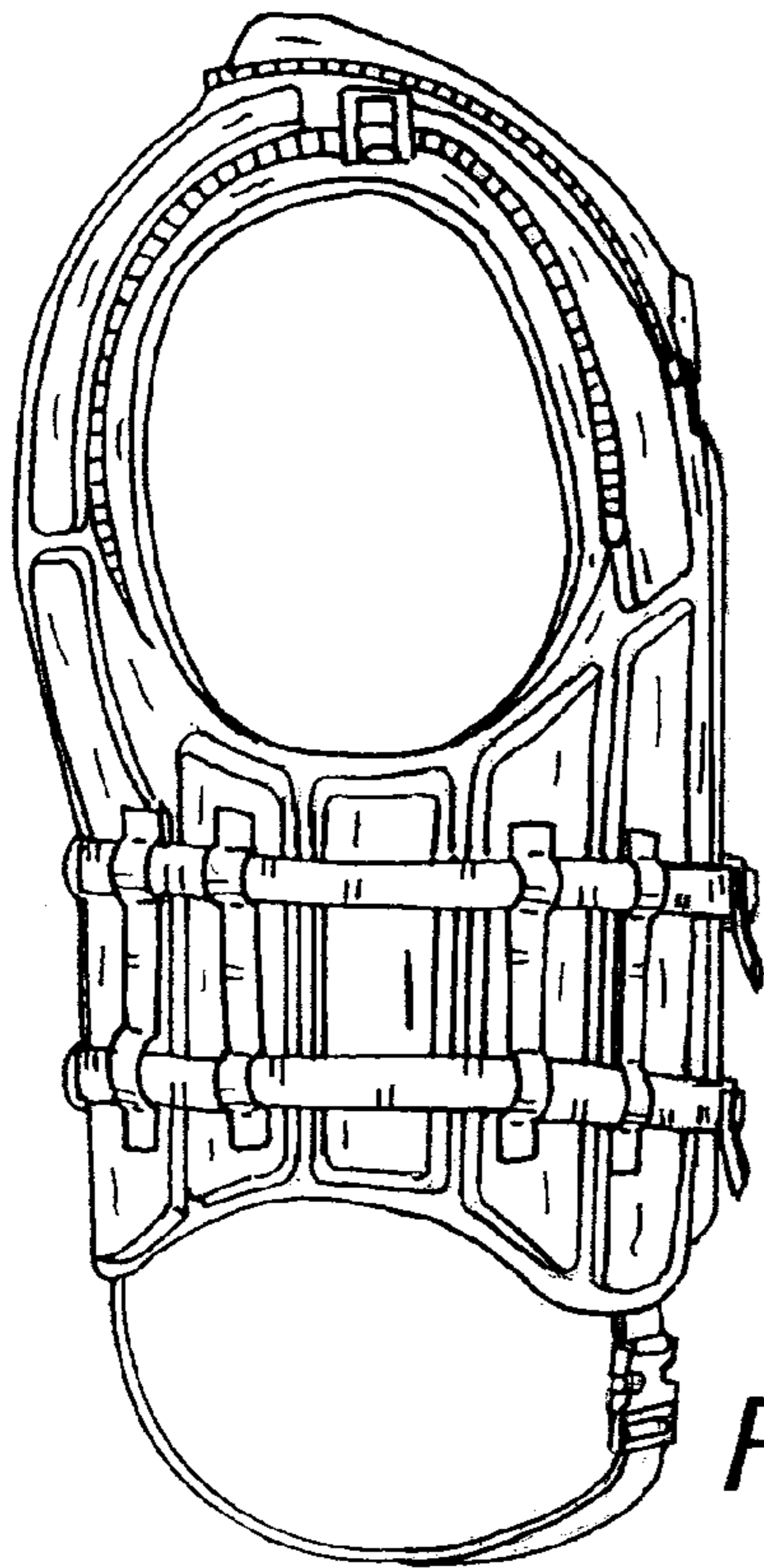
**1 Claim, 3 Drawing Sheets**



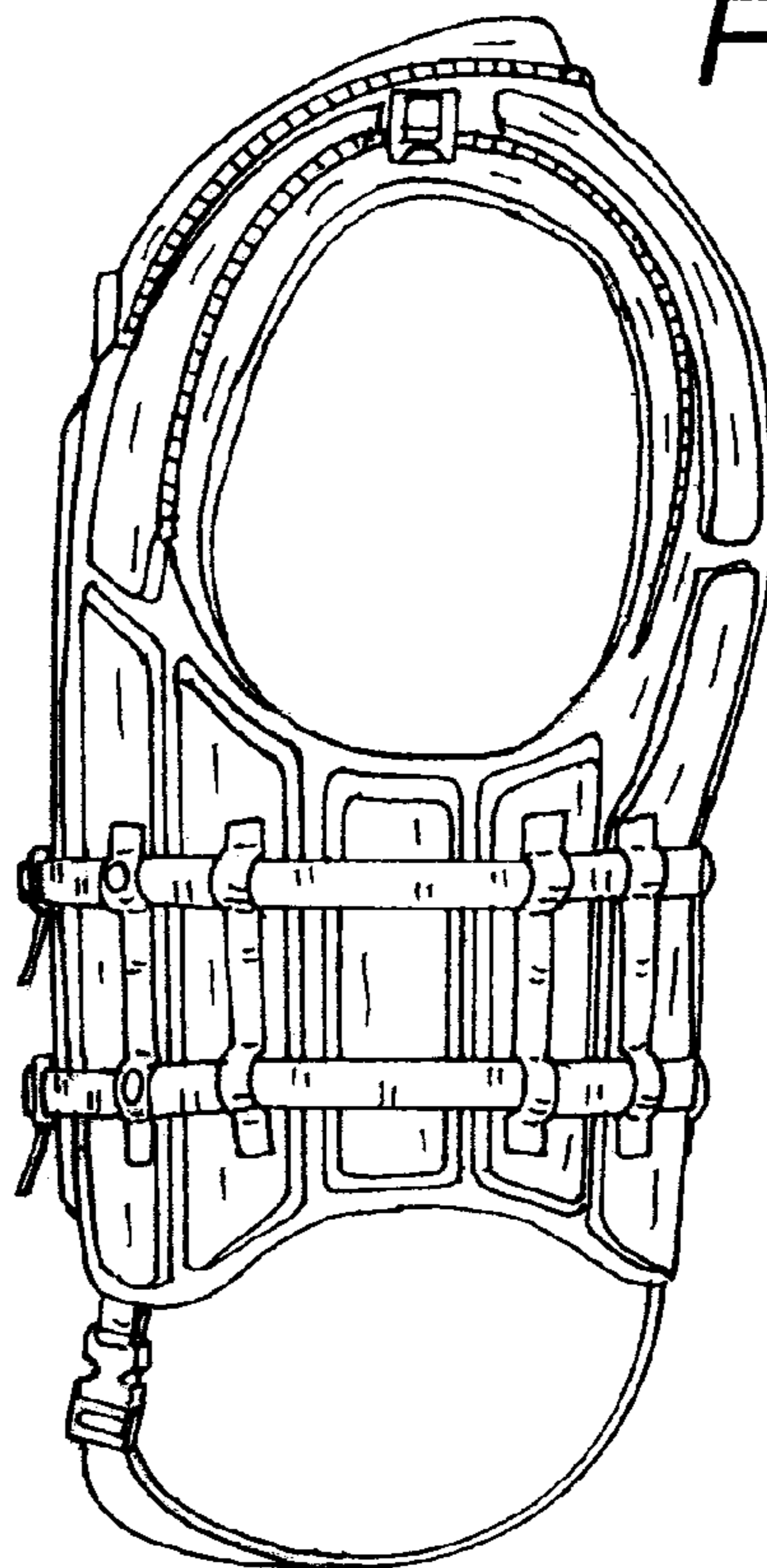
*Fig. 1*

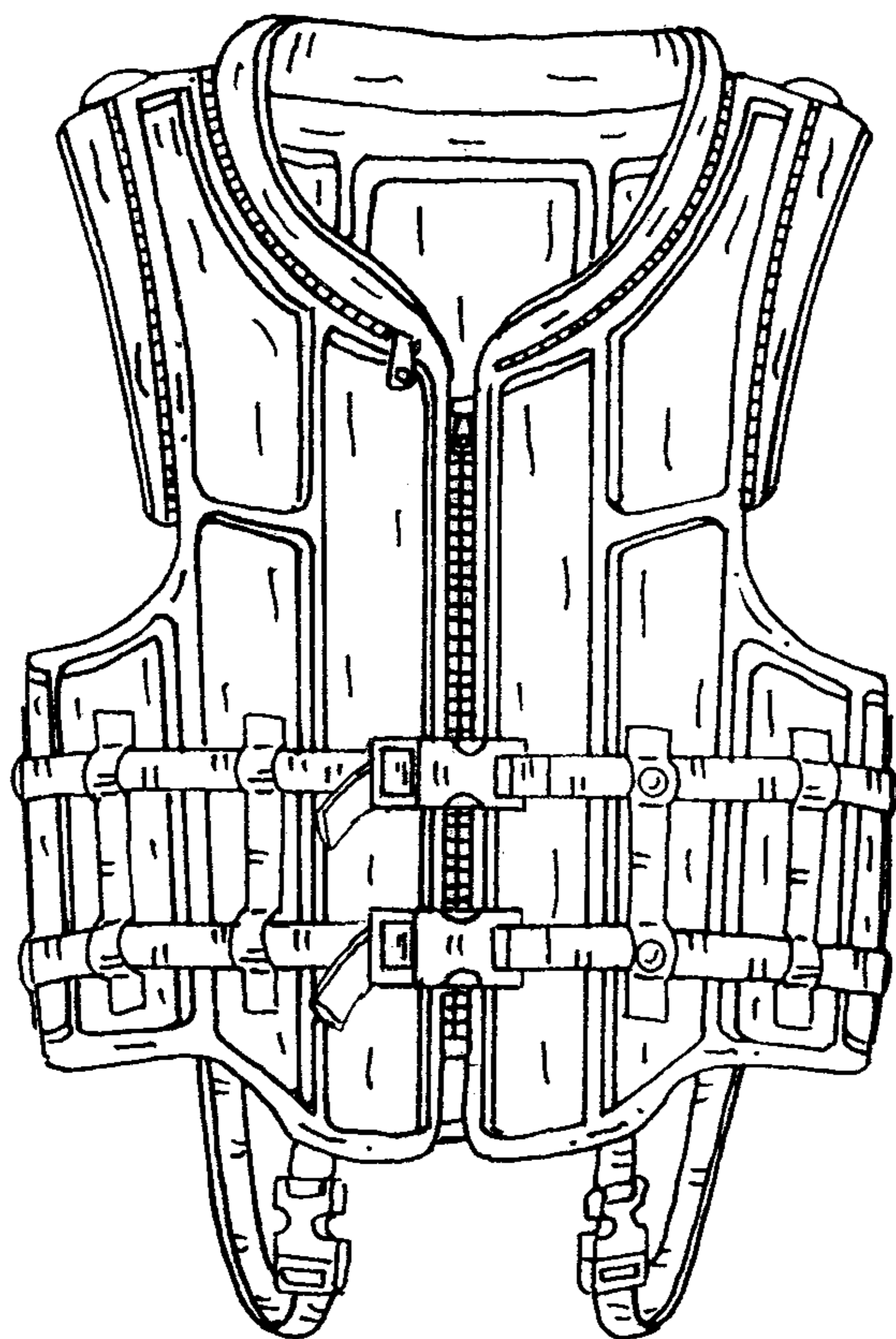


*Fig. 3*



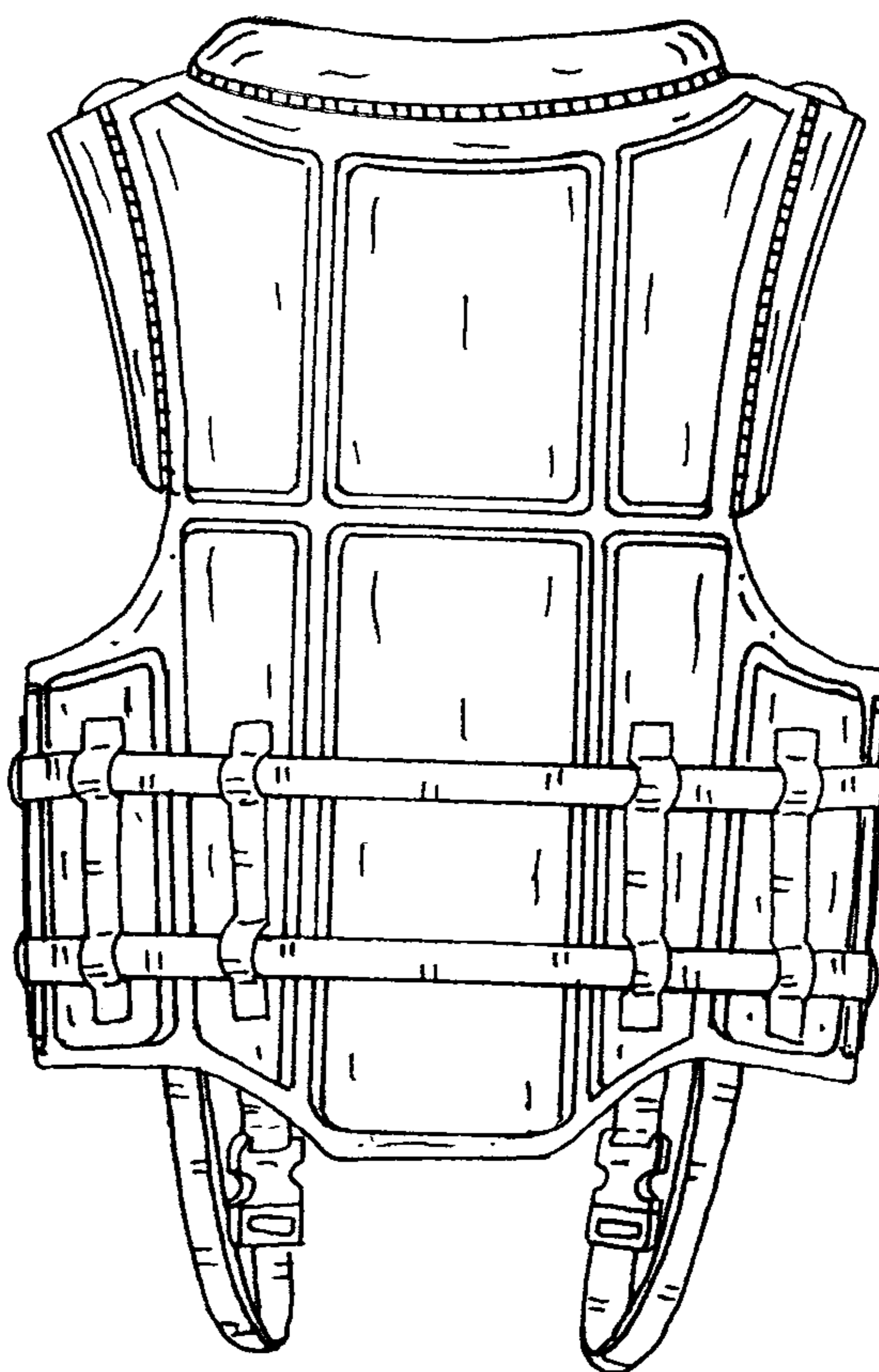
*Fig. 2*

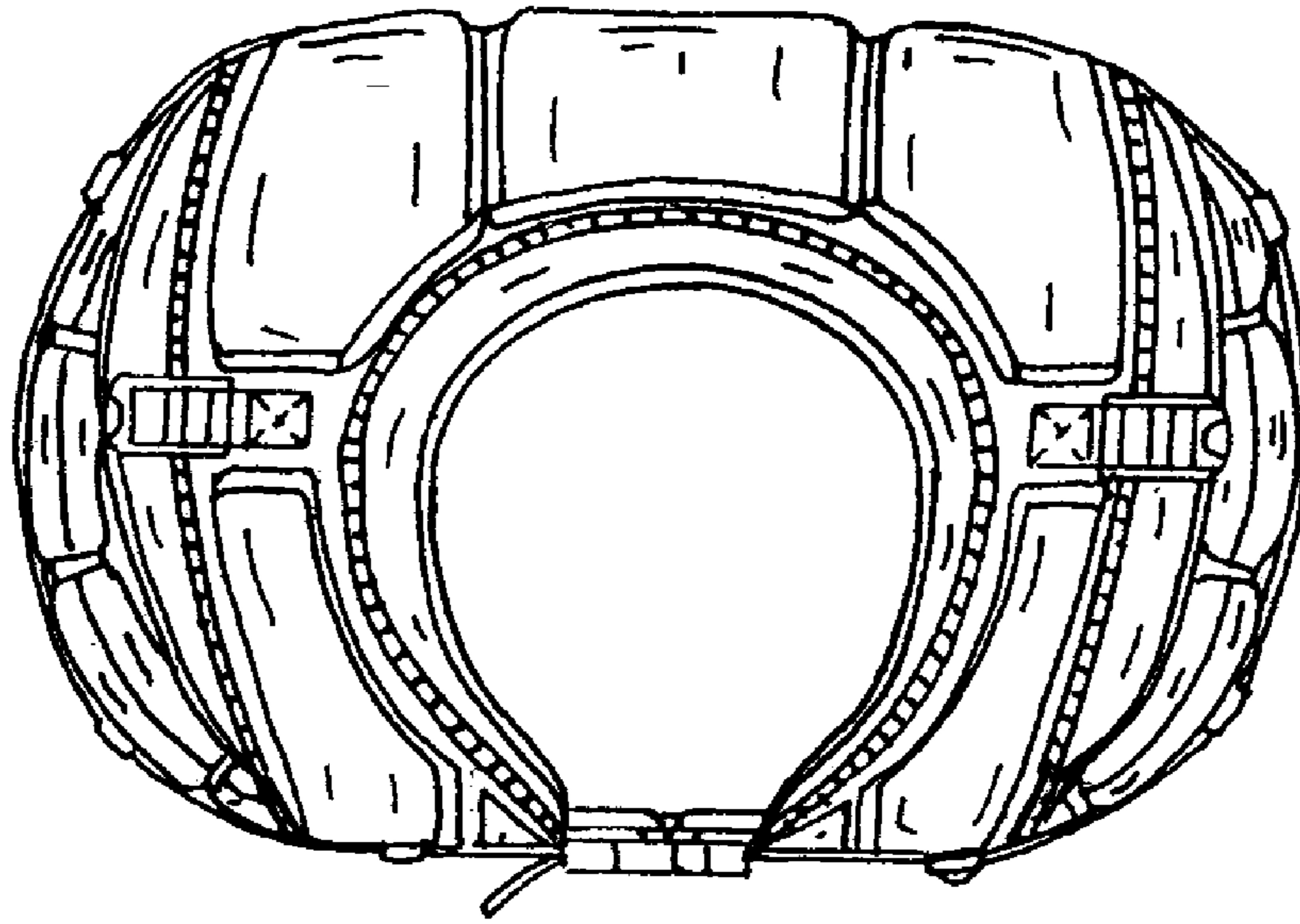




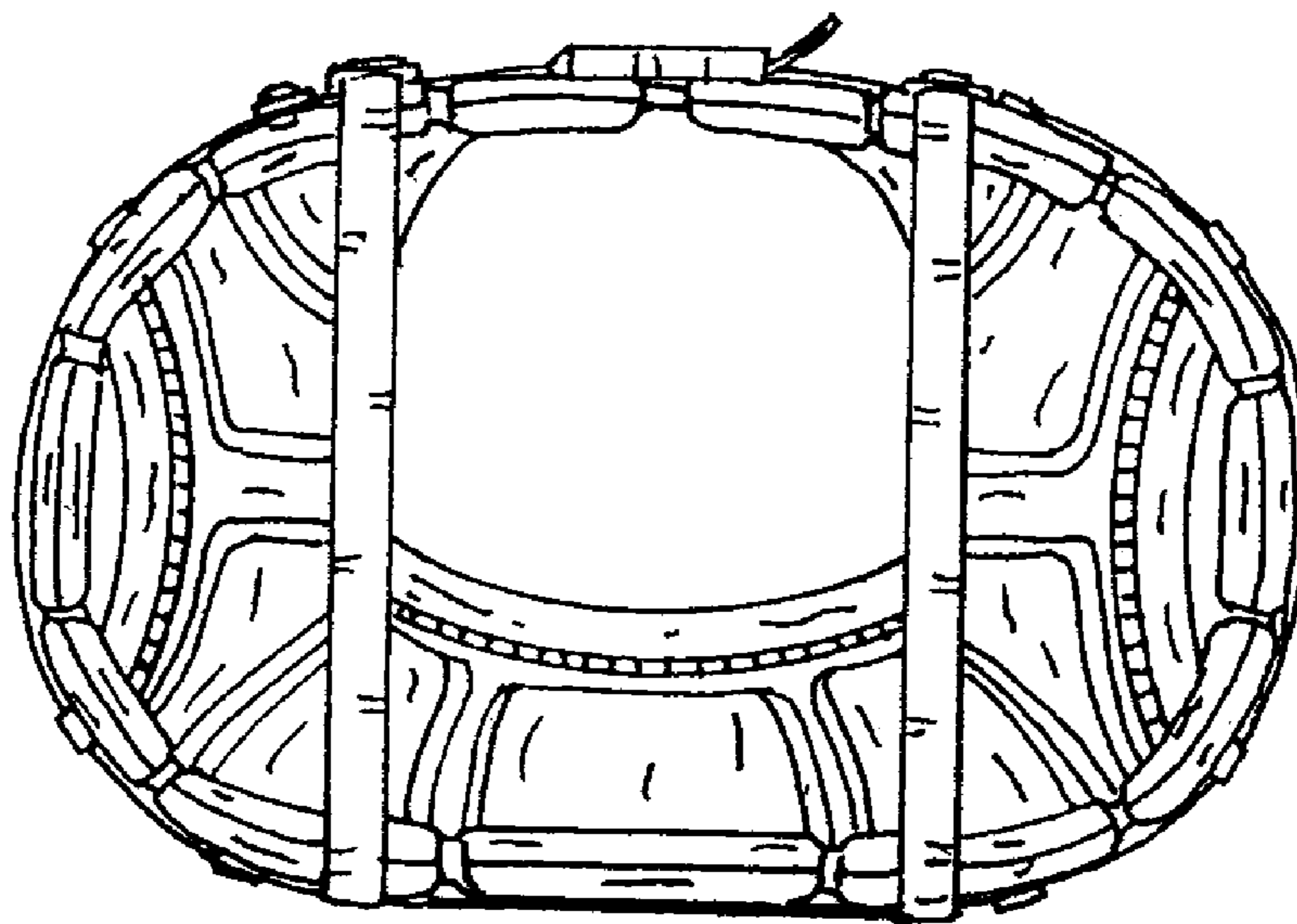
*Fig. 4*

*Fig. 5*





*Fig. 6*



*Fig. 7*