



US00D554205S

(12) **United States Design Patent**  
**Sato et al.**

(10) **Patent No.:** **US D554,205 S**  
(45) **Date of Patent:** **\*\* Oct. 30, 2007**

(54) **TOY**

(75) Inventors: **Wataru Sato**, Kawasaki (JP);  
**Tetsuyoshi Matsumura**, Nagareyama (JP)

(73) Assignee: **Spin Master Ltd.**, Toronto, Ontario (CA)

(\*\*) Term: **14 Years**

(21) Appl. No.: **29/264,343**

(22) Filed: **Aug. 8, 2006**

(30) **Foreign Application Priority Data**

Feb. 20, 2006 (JP) ..... 2006-003817

(51) **LOC (8) Cl.** ..... **21-01**

(52) **U.S. Cl.** ..... **D21/579**

(58) **Field of Classification Search** ..... D21/621,  
D21/623, 578-583, 659; 446/268, 305, 360-361,  
446/376, 379, 382-384, 136, 266-267, 272;  
434/266-267, 272

See application file for complete search history.

(56) **References Cited**

**U.S. PATENT DOCUMENTS**

- D286,800 S \* 11/1986 Maruyama ..... D21/584
- D287,258 S \* 12/1986 Maruyama ..... D21/579
- D292,110 S \* 9/1987 Tamakoshi ..... D21/578
- D296,916 S \* 7/1988 Matsuda ..... D21/513
- D297,749 S \* 9/1988 Rodis-Jamero ..... D21/578
- D298,150 S \* 10/1988 Torres et al. .... D21/579
- D298,151 S \* 10/1988 Torres et al. .... D21/579

\* cited by examiner

*Primary Examiner*—Janice E. Seeger

*Assistant Examiner*—Zenia I. Bennett

(74) *Attorney, Agent, or Firm*—Cohen Pontani Lieberman & Pavane LLP

(57) **CLAIM**

The ornamental design for a toy, as shown and described.

**DESCRIPTION**

FIG. 1 is a perspective view of the toy of the present design in its open state;

FIG. 2 is a front view of the toy of the present design in its open state;

FIG. 3 is a rear view of the toy of the present design in its open state;

FIG. 4 is a right side view of the toy of the present design in its open state;

FIG. 5 is a left side view of the toy of the present design in its open state;

FIG. 6 is a top view of the toy of the present design in its open state;

FIG. 7 is a bottom view of the toy of the present design in its open state;

FIG. 8 is a perspective view of the toy of the present design in its closed state;

FIG. 9 is a front view of the toy of the present design in its closed state;

FIG. 10 is a rear view of the toy of the present design in its closed state;

FIG. 11 is a right side view of the toy of the present design in its closed state;

FIG. 12 is a left side view of the toy of the present design in its closed state;

FIG. 13 is a top view of the toy of the present design in its closed state;

FIG. 14 is a bottom view of the toy of the present design in its closed state; and,

FIG. 15 is a perspective view of the toy of the present design, in its open state in an environment for use.

The broken lines are for environmental purposes only and form no part of the claimed design.

**1 Claim, 4 Drawing Sheets**

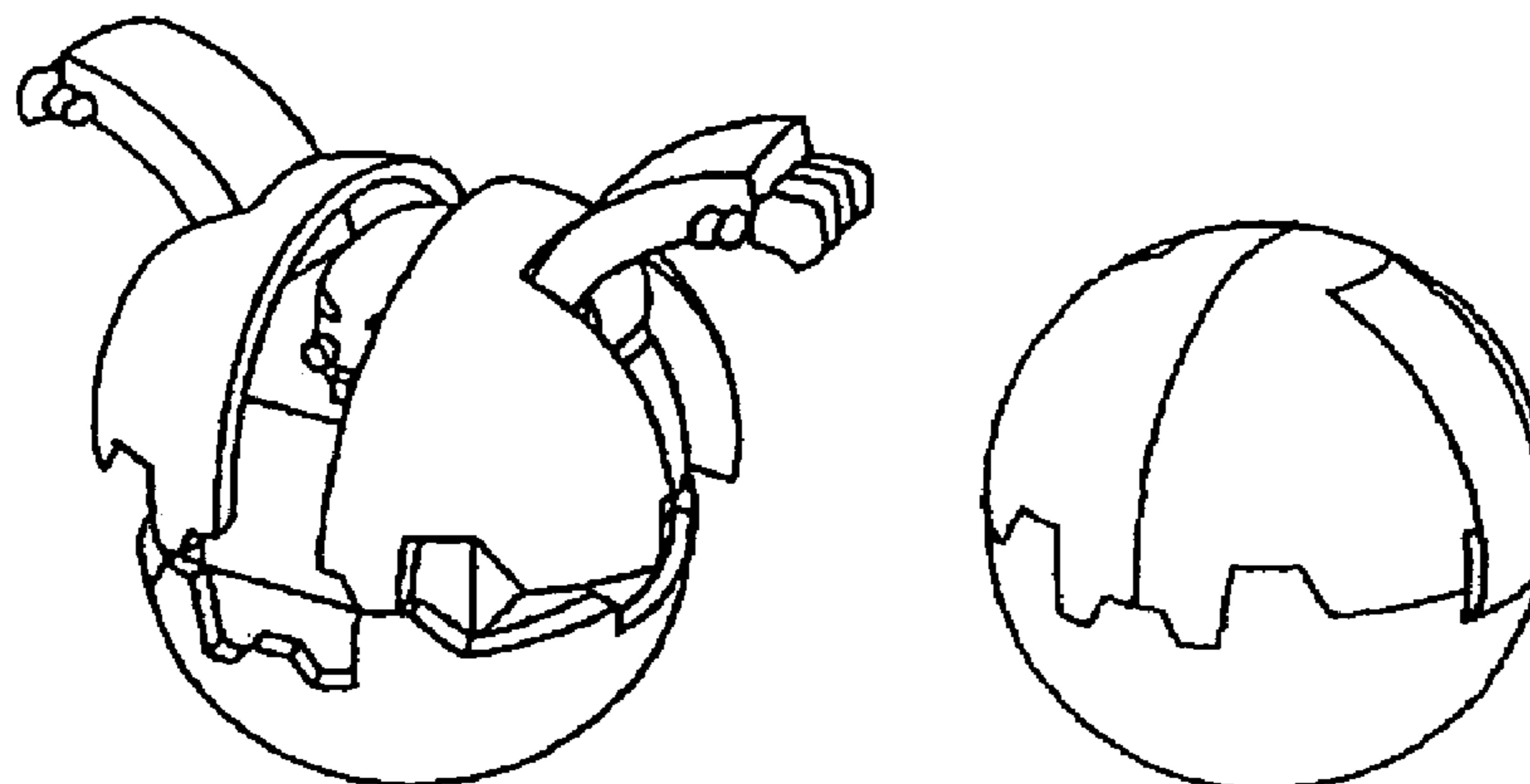

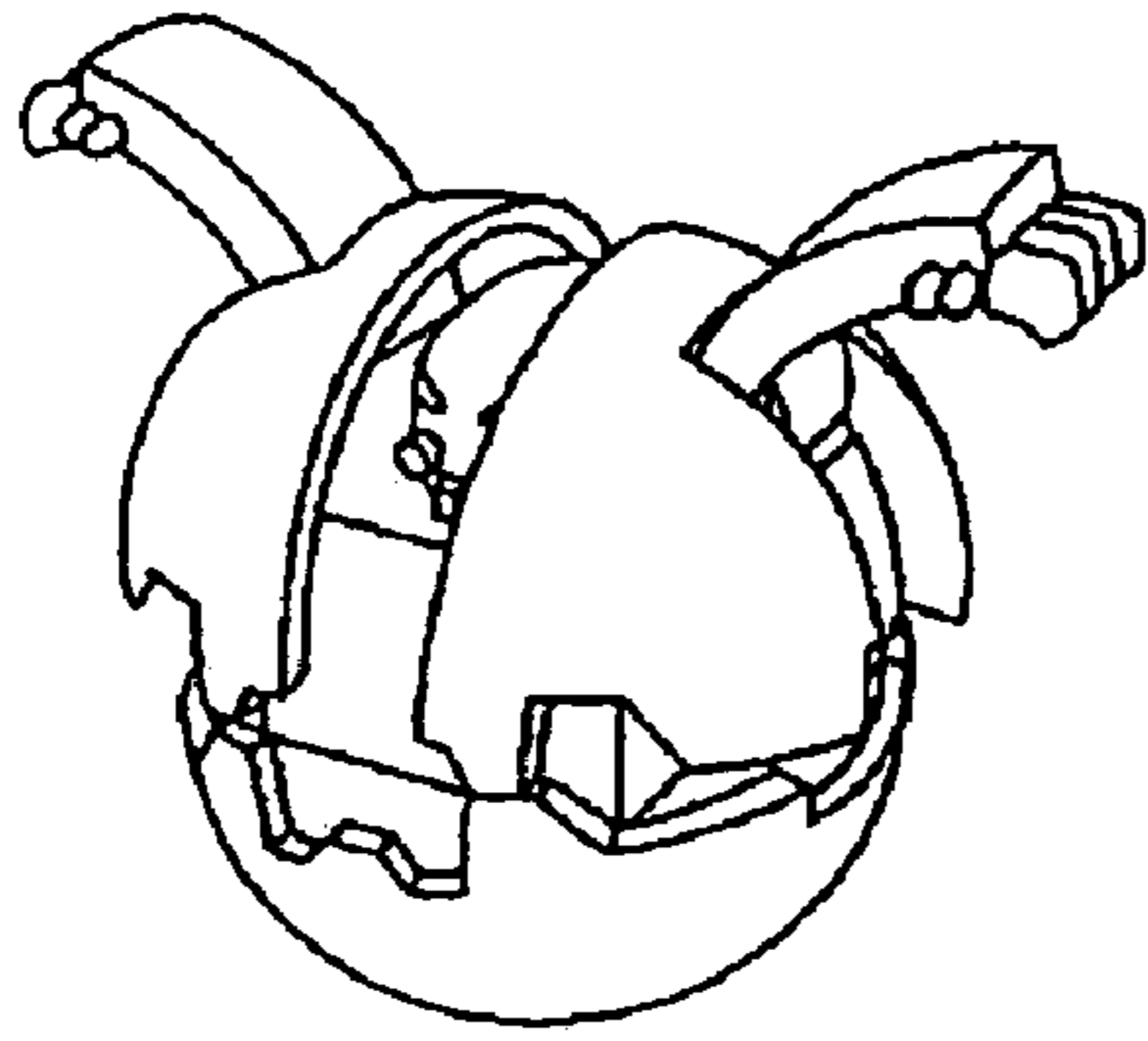

FIGURE 1

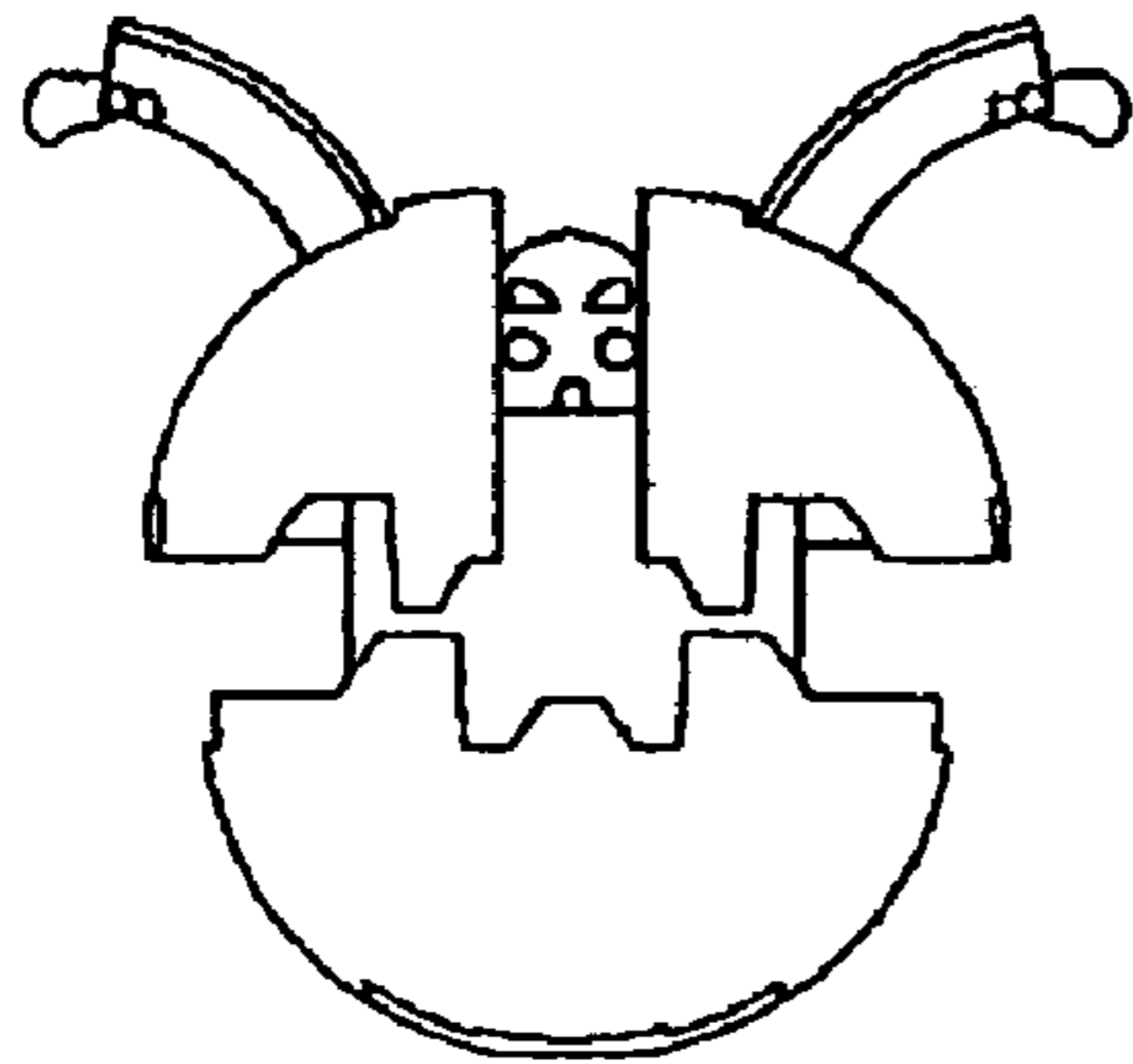

FIGURE 2

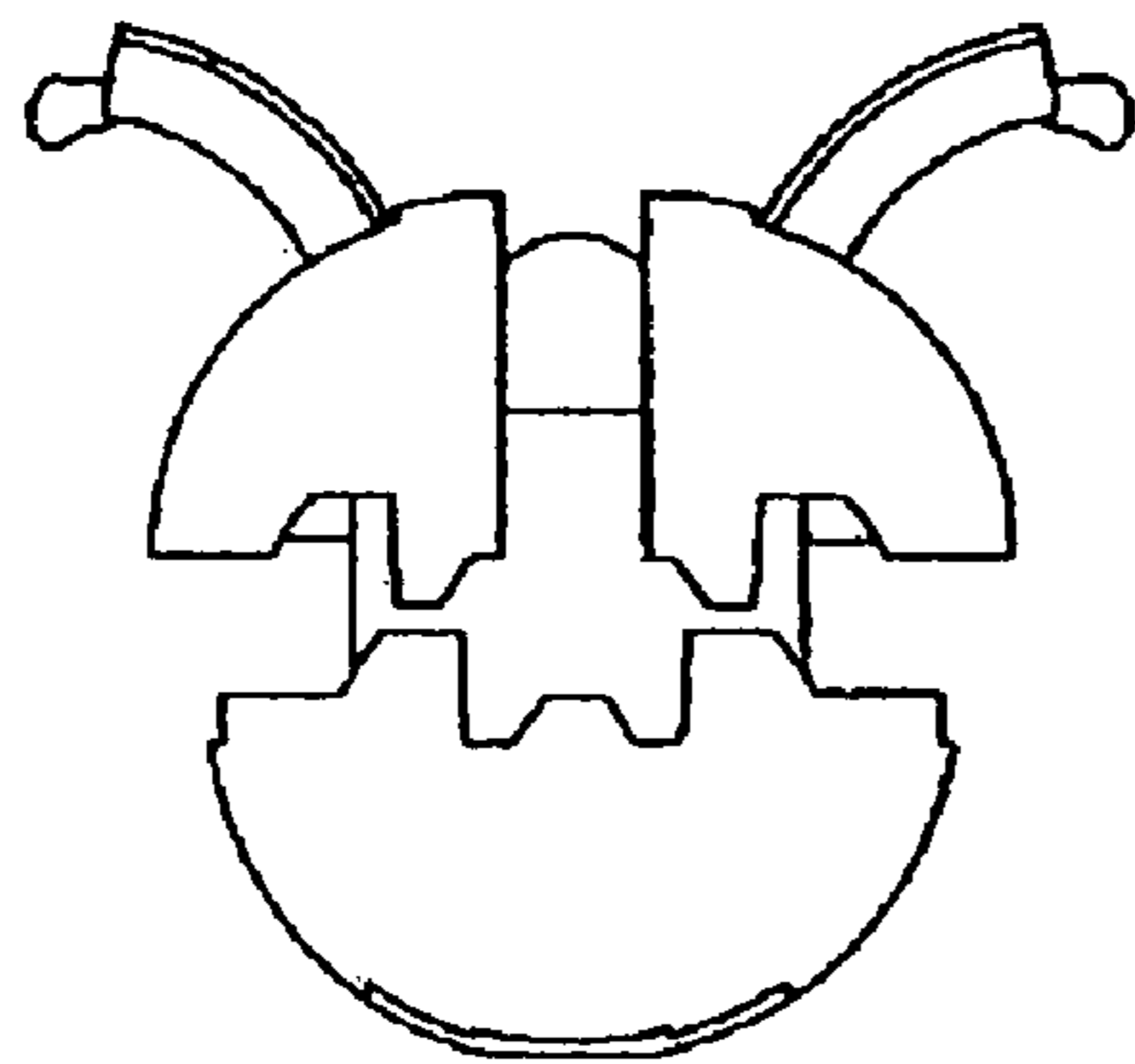

FIGURE 3

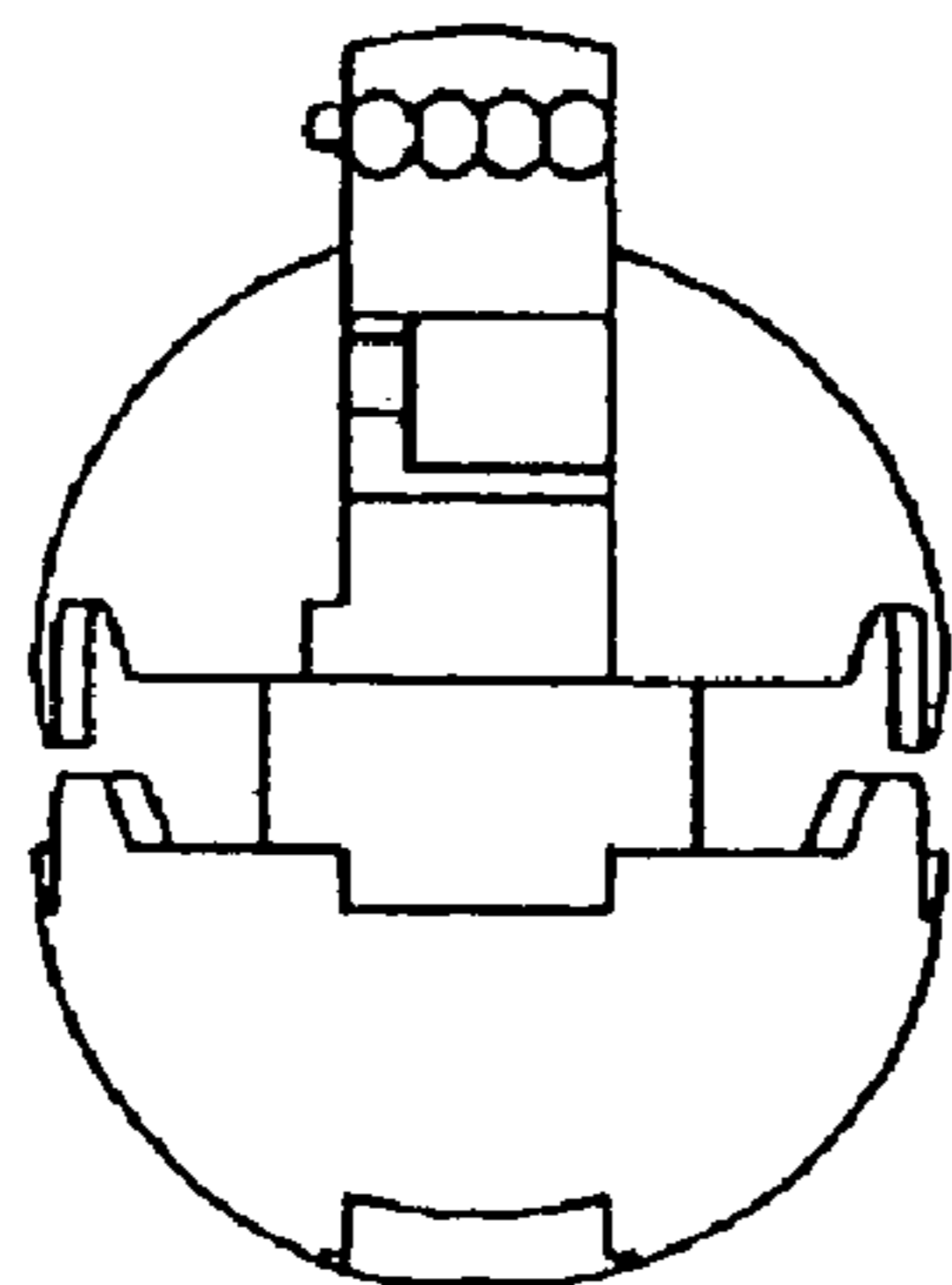

FIGURE 4

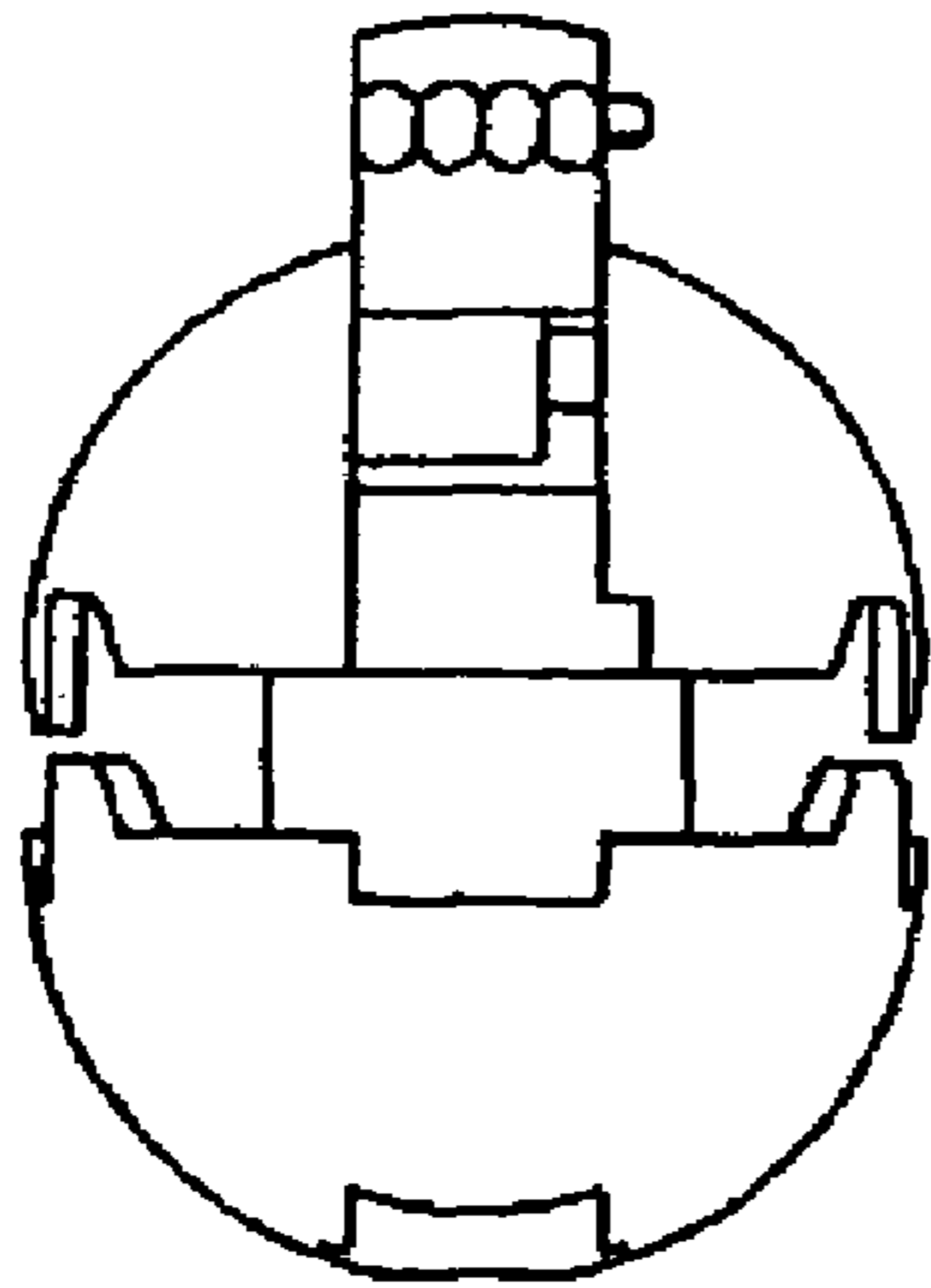

FIGURE 5

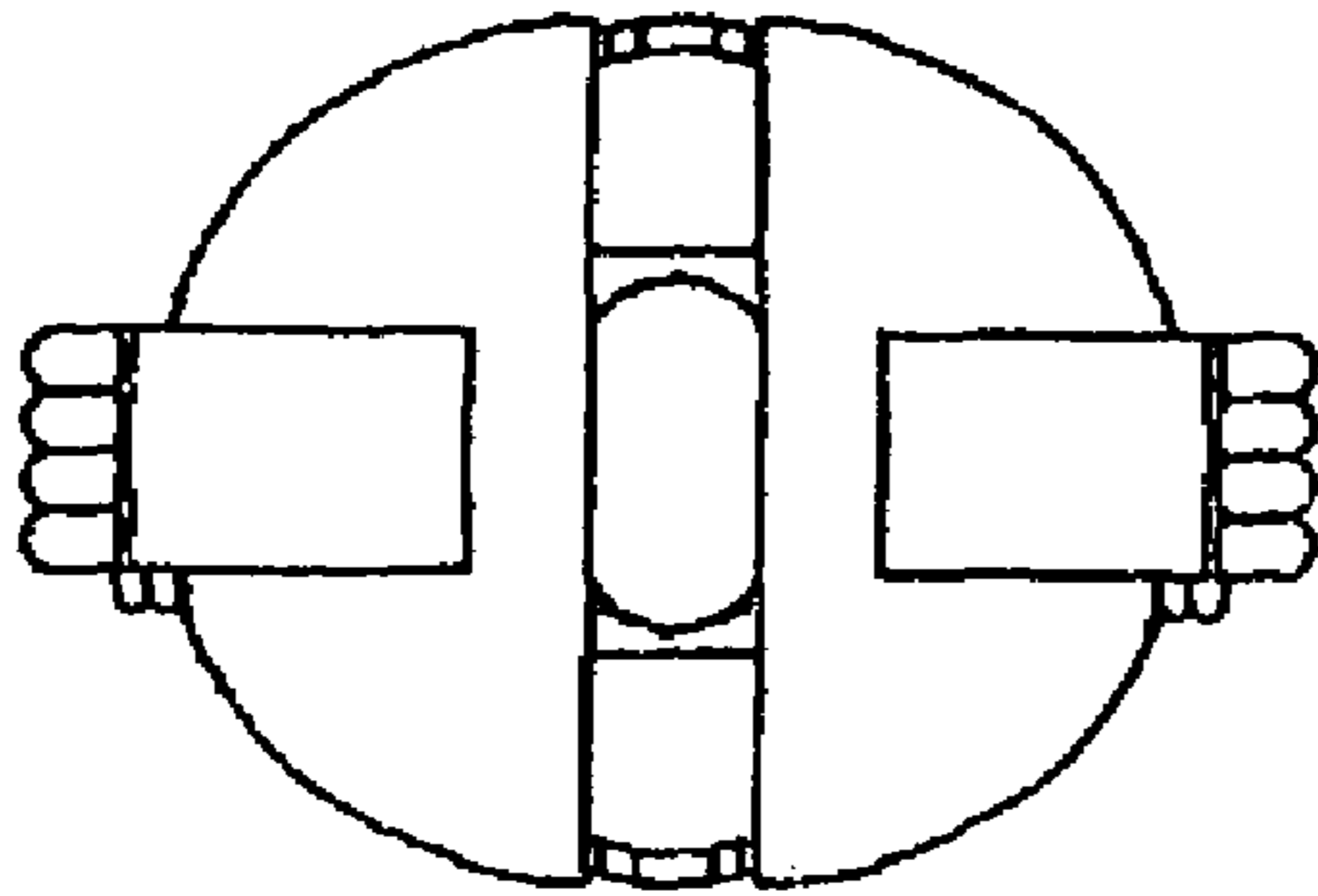

FIGURE 6

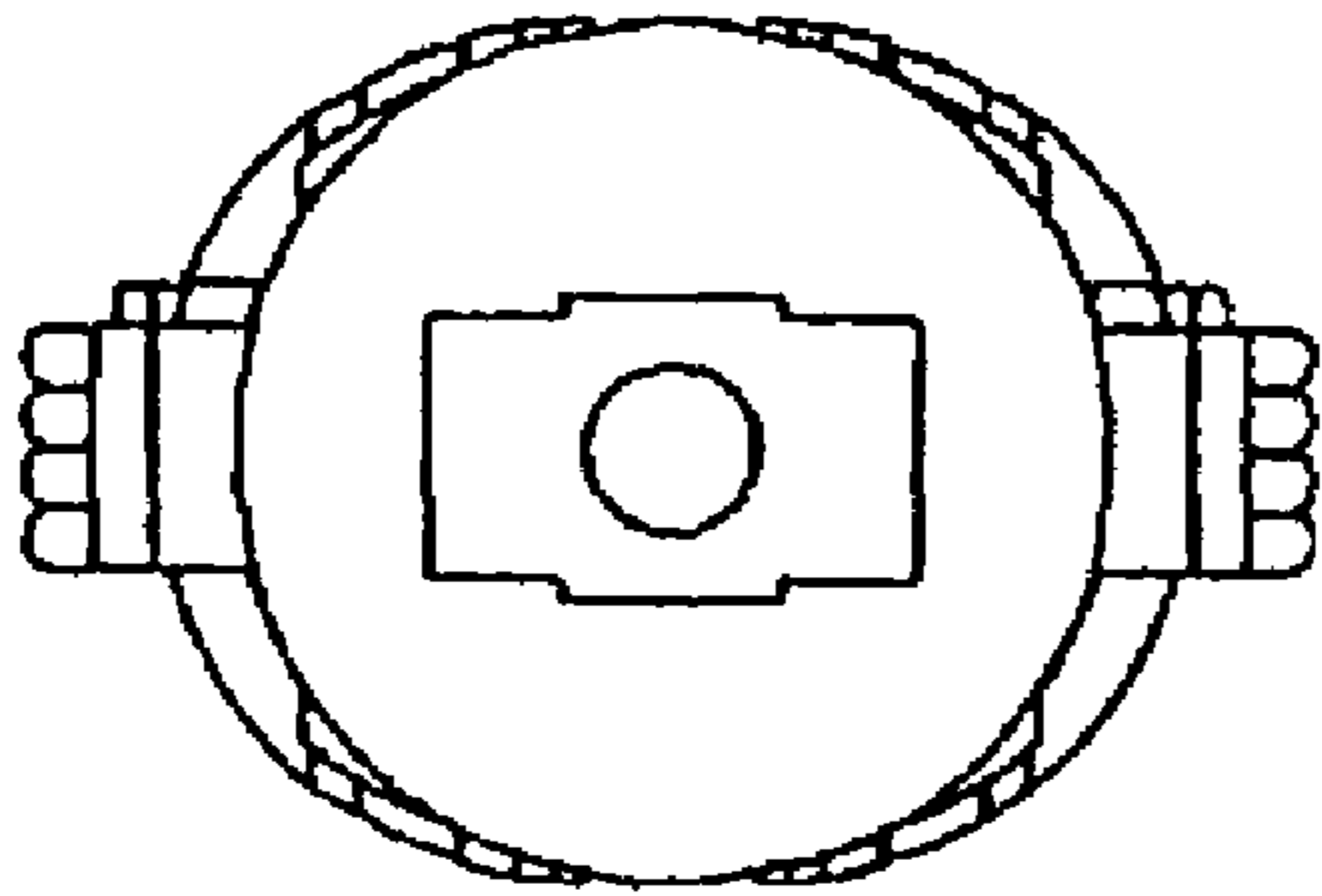

FIGURE 7

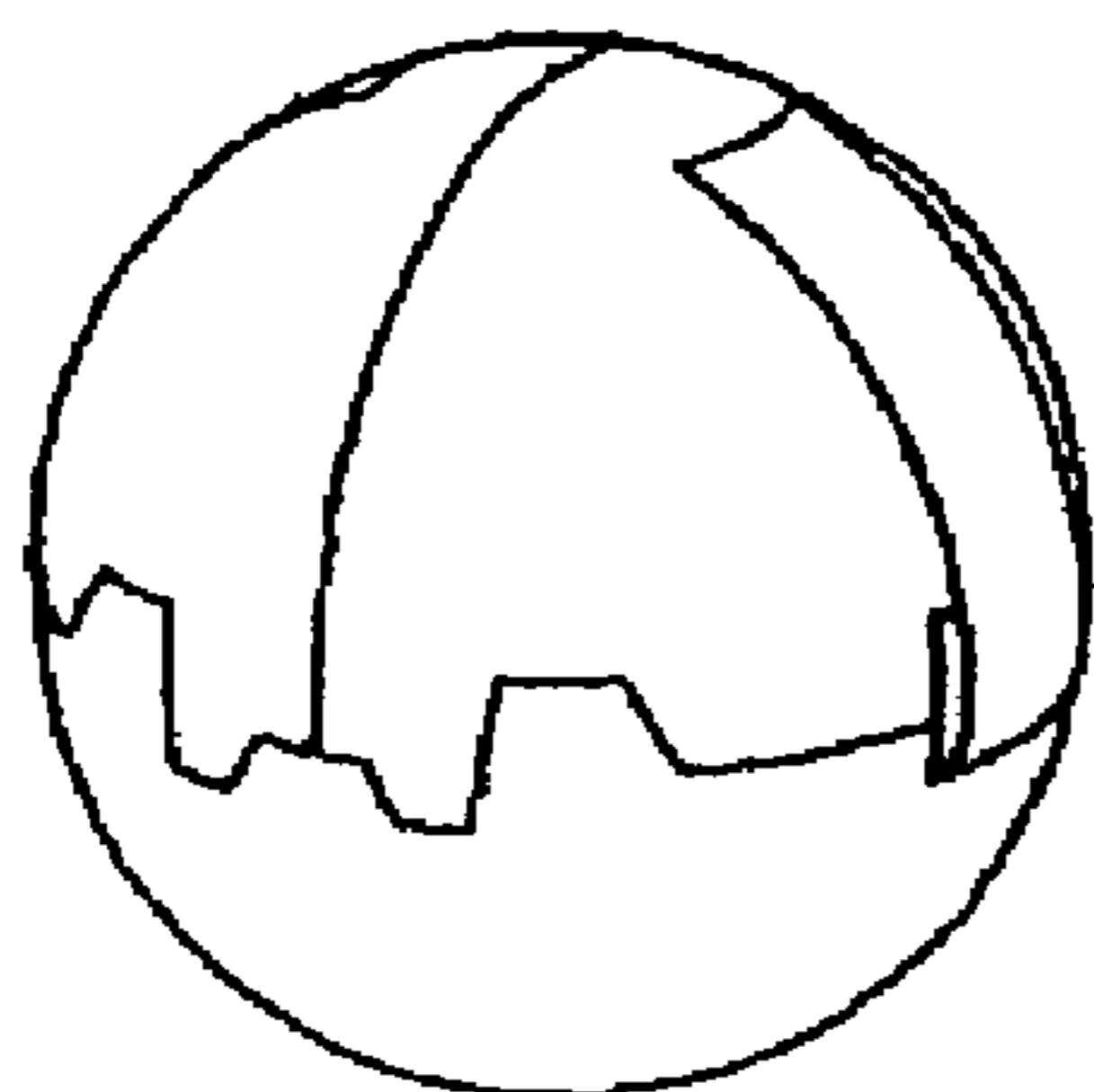

FIGURE 8

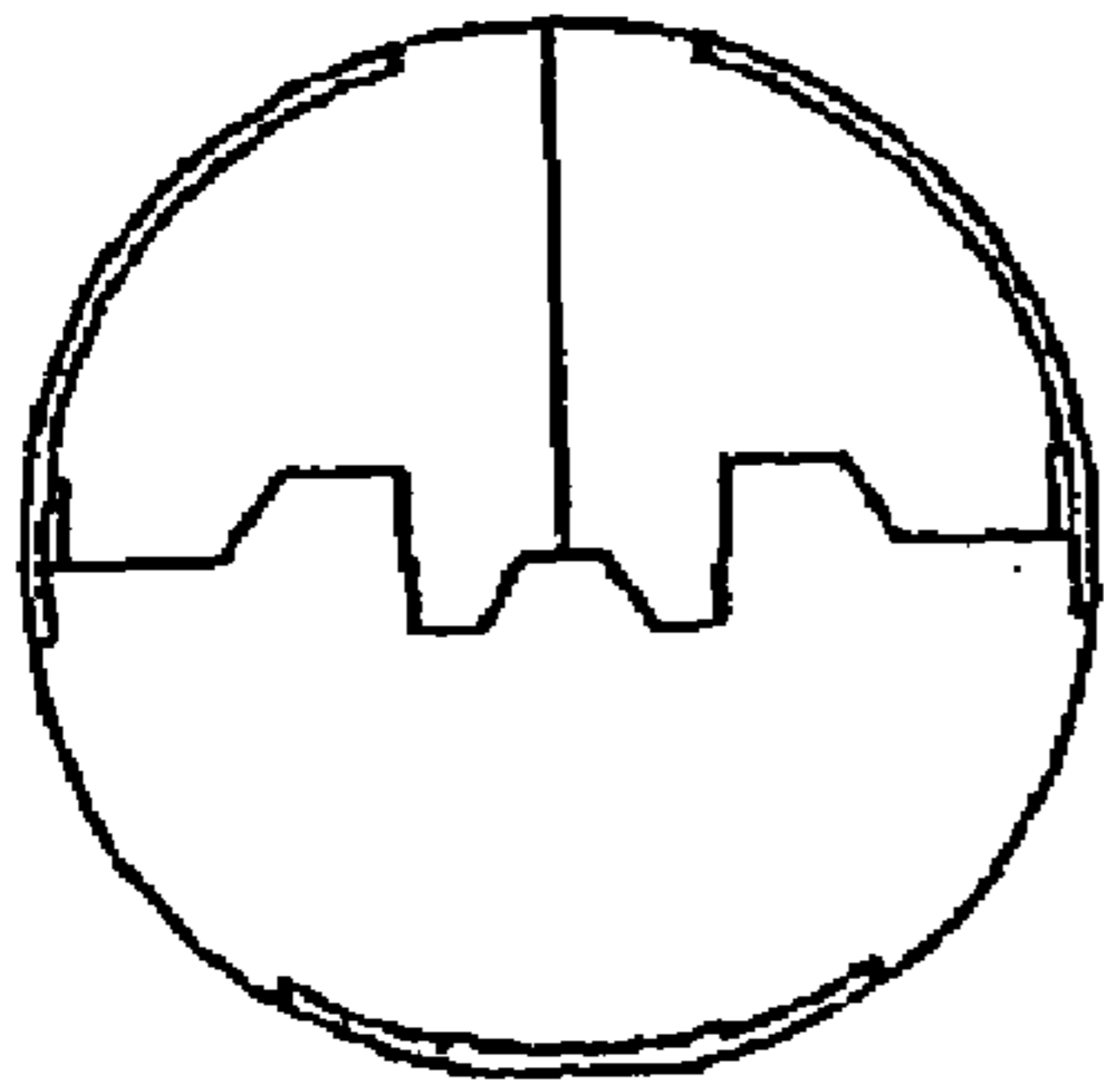

FIGURE 9

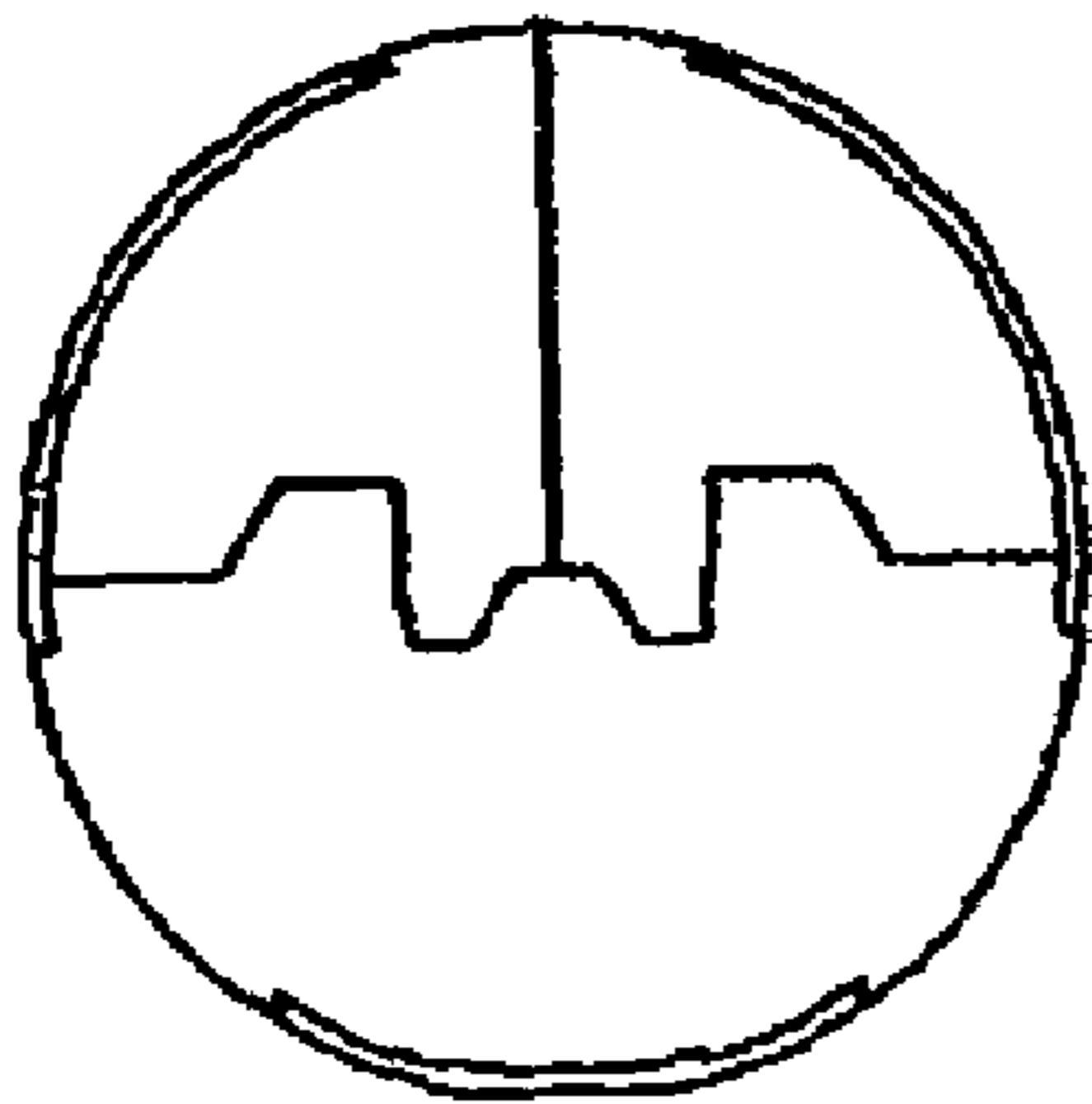

FIGURE 10

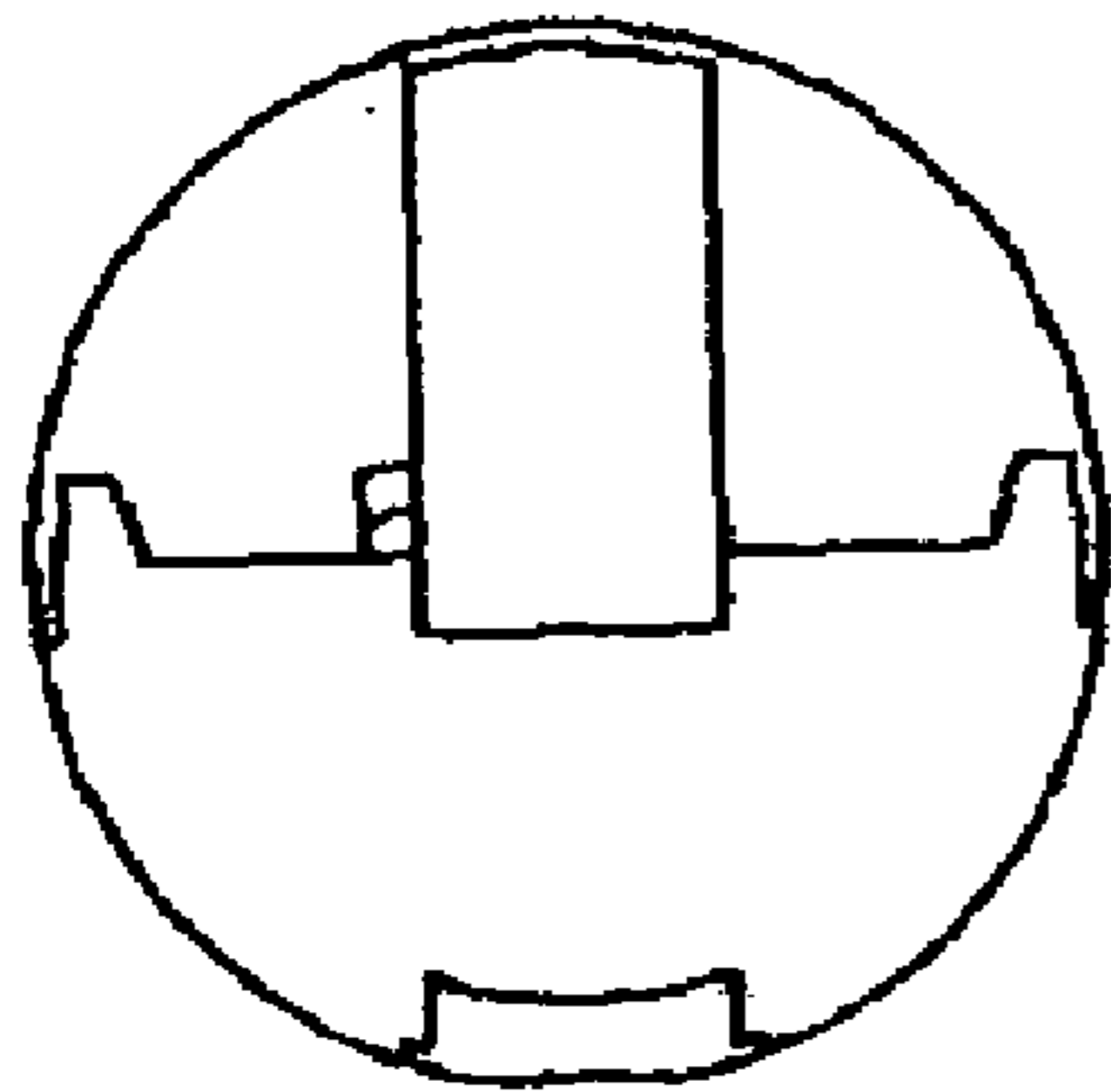

FIGURE 11

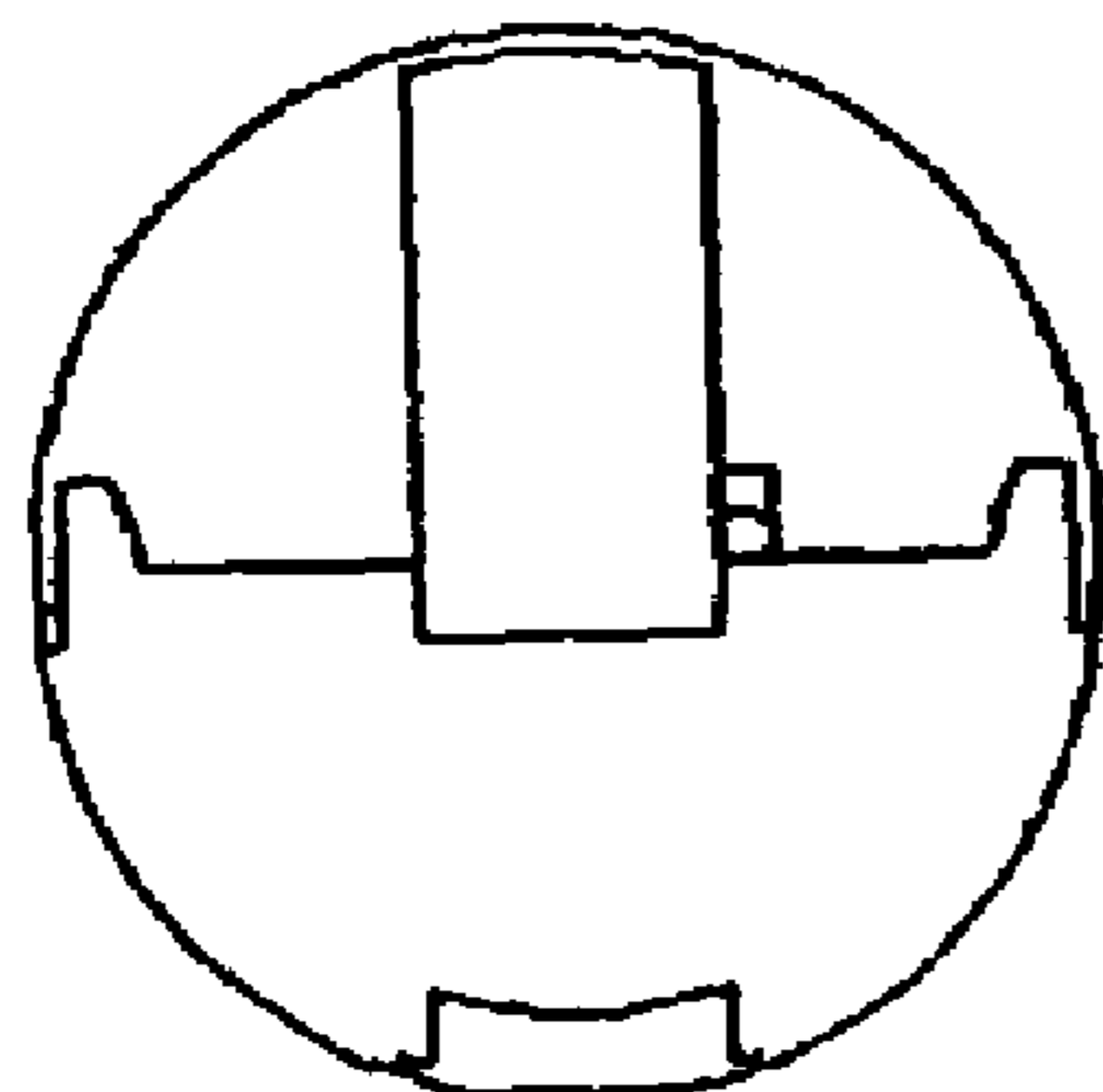

FIGURE 12

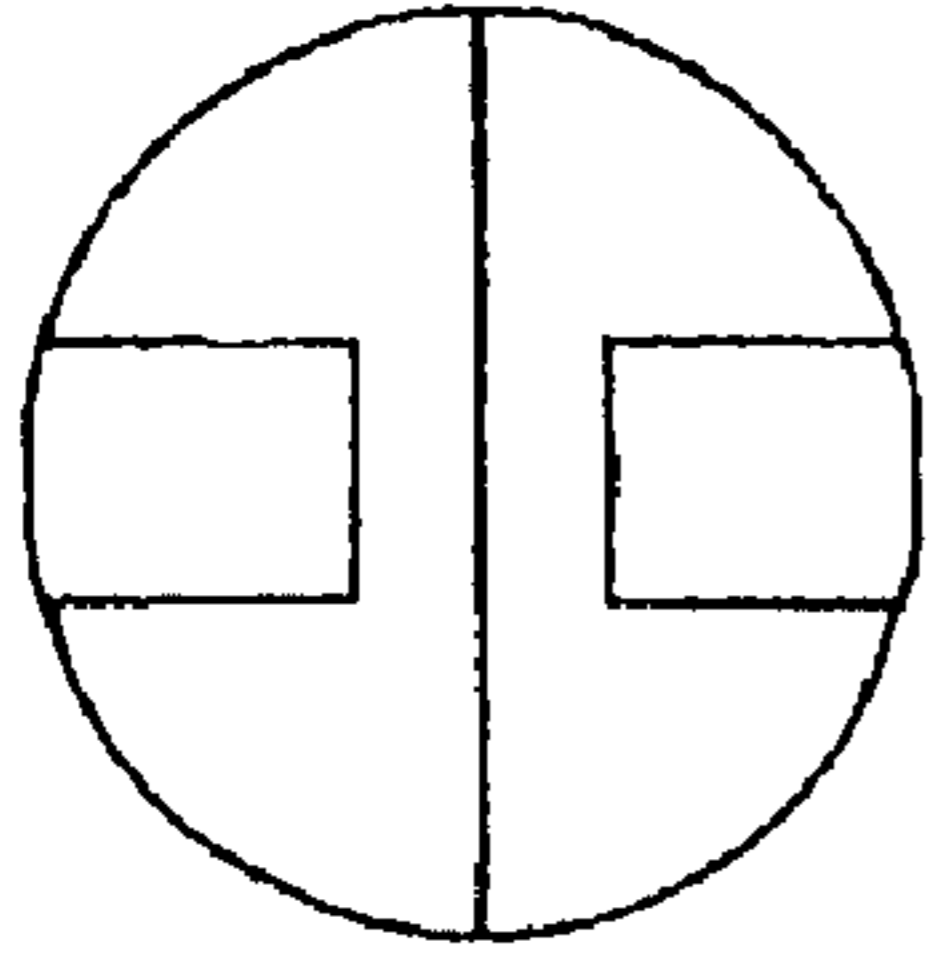

FIGURE 13

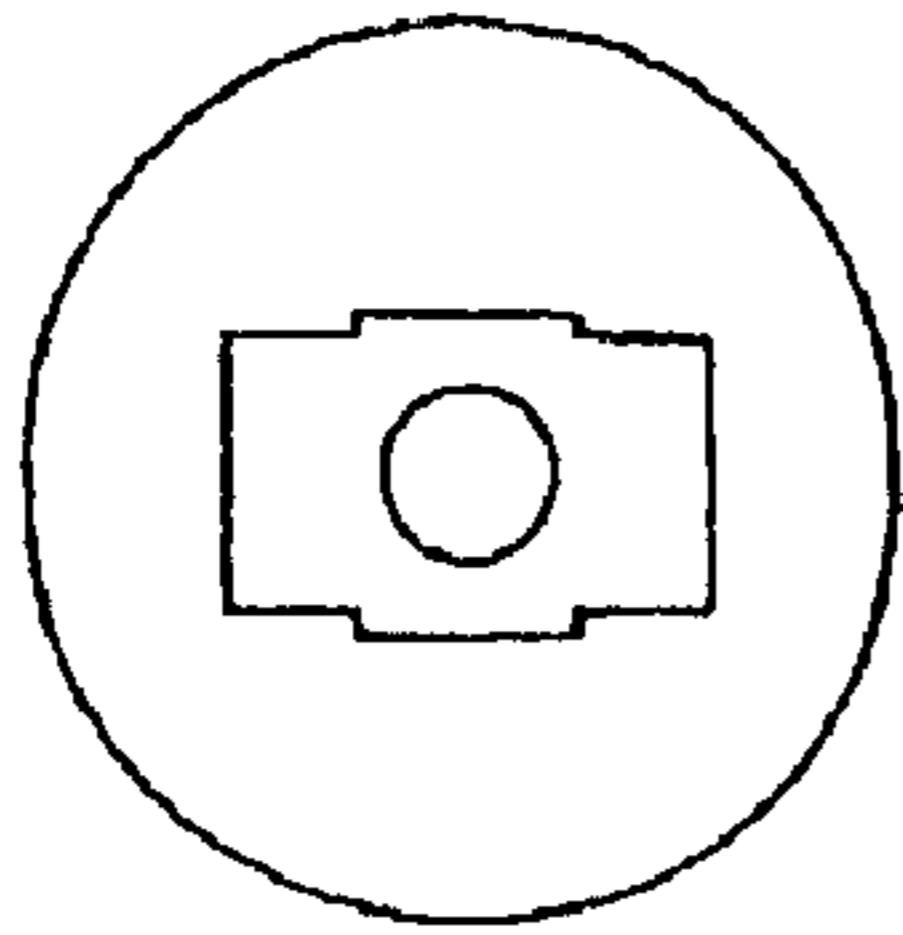

FIGURE 14

FIGURE 15

