



US00D554194S

(12) **United States Design Patent** (10) **Patent No.:** **US D554,194 S**
Ehara et al. (45) **Date of Patent:** **** Oct. 30, 2007**

(54) **ELECTRONIC GAME MACHINE** 6,958,902 B2 * 10/2005 Tseng et al. 361/681
D523,238 S 6/2006 Miyamoto et al.
(75) Inventors: **Yui Ehara**, Kyoto (JP); **Tomoki Yamamoto**, Kyoto (JP) D524,870 S 7/2006 Sugino
D532,051 S * 11/2006 Sugino et al. D21/330

(73) Assignee: **Nintendo Co., Ltd.**, Kyoto (JP)

* cited by examiner

(**) Term: **14 Years**

Primary Examiner—Prabhakar Deshmukh
(74) *Attorney, Agent, or Firm*—Nixon & Vanderhye, PC

(21) Appl. No.: **29/263,341**

(57) **CLAIM**

(22) Filed: **Jul. 21, 2006**

The ornamental design for an electronic game machine, as shown and described.

(30) **Foreign Application Priority Data**

Jan. 26, 2006 (JP) 2006-001637

DESCRIPTION

(51) **LOC (8) Cl.** **21-01**
(52) **U.S. Cl.** **D21/330**
(58) **Field of Classification Search** D21/324,
D21/329, 330, 333; D14/496, 125; 273/148 B,
273/148 R; 463/1, 2, 29–35, 46, 47; 345/156,
345/173, 867, 903; 361/679, 681, 682, 500
See application file for complete search history.

FIG. 1 is front, top and right perspective view of an electronic game machine showing our new design, a lid with display being opened;
FIG. 2 is rear, bottom and left perspective view thereof;
FIG. 3 is a top plan view thereof;
FIG. 4 is a bottom plan view thereof;
FIG. 5 is a front view thereof;
FIG. 6 is a rear view thereof;
FIG. 7 is a right side view thereof;
FIG. 8 is a left side view thereof;
FIG. 9 is a top, front and right perspective view of thereof, the lid with display being closed;
FIG. 10 is a top plan view thereof;
FIG. 11 is a bottom plan view thereof;
FIG. 12 is a front view thereof;
FIG. 13 is a rear view thereof;
FIG. 14 is a right side view thereof; and,
FIG. 15 is a left side view thereof.

(56) **References Cited**

U.S. PATENT DOCUMENTS

D275,971 S * 10/1984 Yokoi D21/330
4,542,903 A * 9/1985 Yokoi et al. 463/31
D318,884 S 8/1991 Kojo
D319,823 S 9/1991 Kojo
D333,493 S * 2/1993 Sato D21/330
D347,450 S 5/1994 Nagata et al.
5,396,346 A * 3/1995 Nakayama et al. 358/448
D378,686 S * 4/1997 Proctor et al. D19/60
D452,280 S 12/2001 Ota et al.
D453,536 S 2/2002 Ota et al.
6,400,351 B1 * 6/2002 Ishizawa et al. 345/156
6,498,721 B1 * 12/2002 Kim 361/681
D484,918 S * 1/2004 Okada et al. D21/330
D494,190 S * 8/2004 Hong et al. D14/496
6,850,407 B2 * 2/2005 Tanimoto et al. 361/681

1 Claim, 8 Drawing Sheets

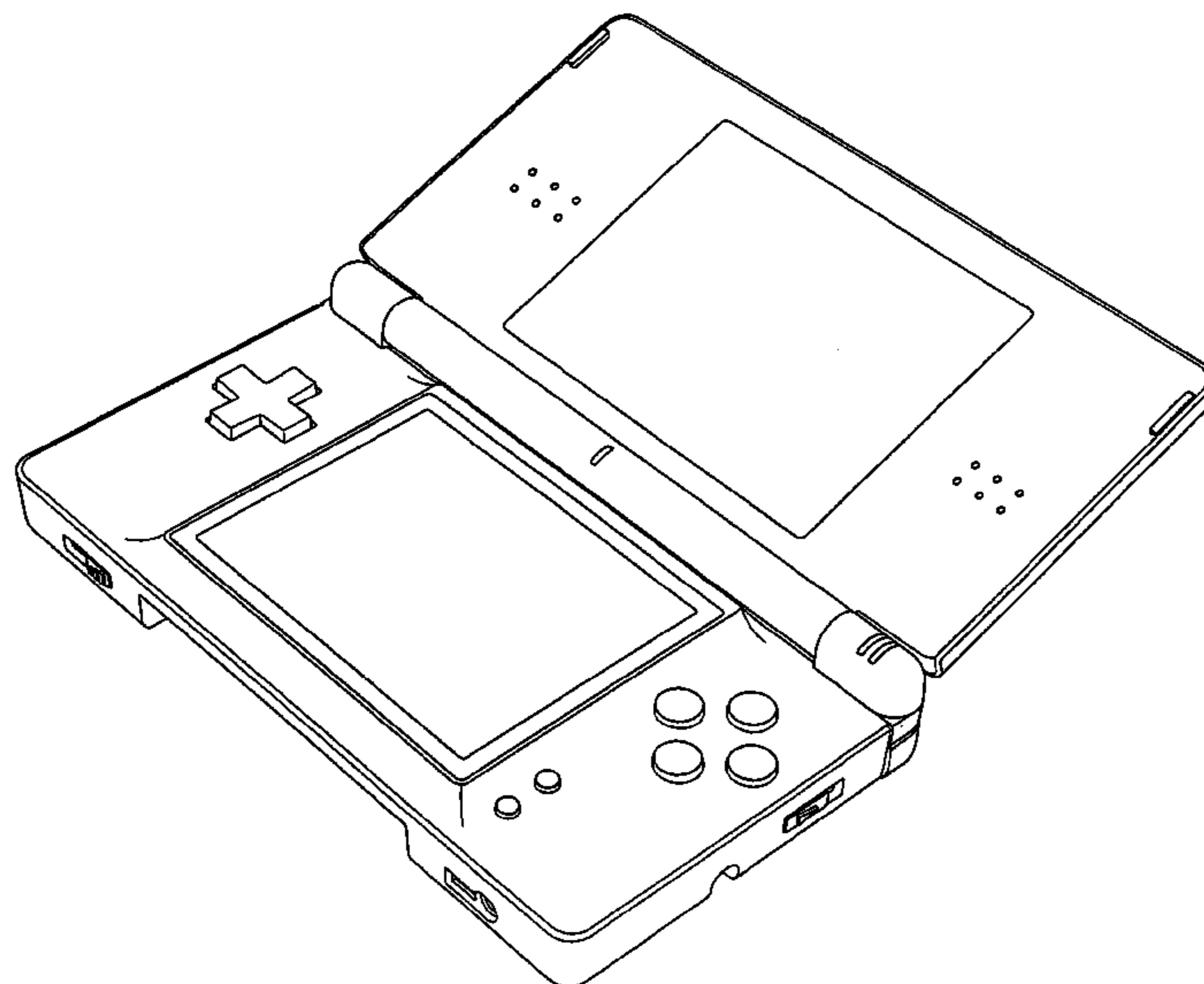

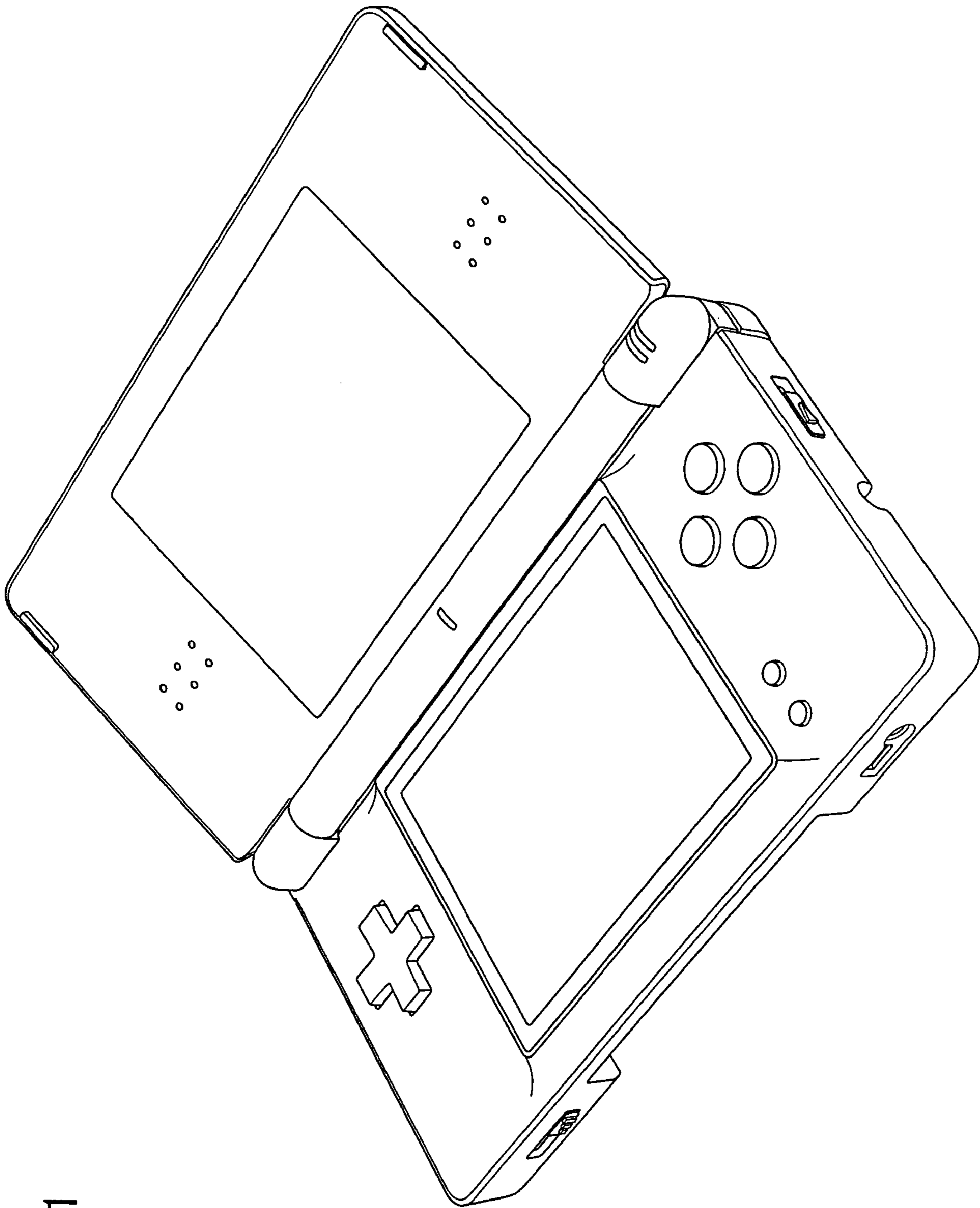

FIG. 1

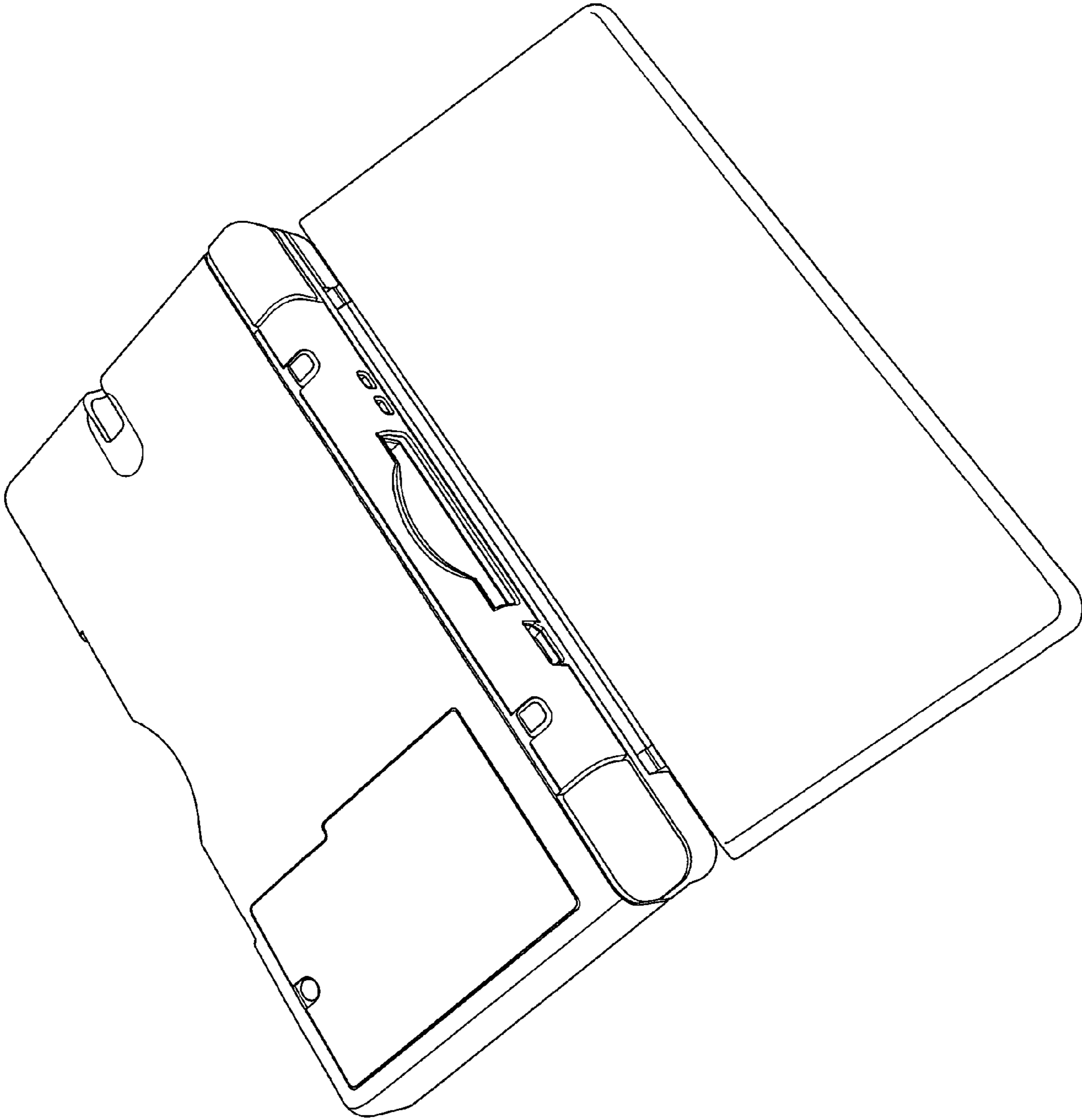

FIG. 2

FIG. 3

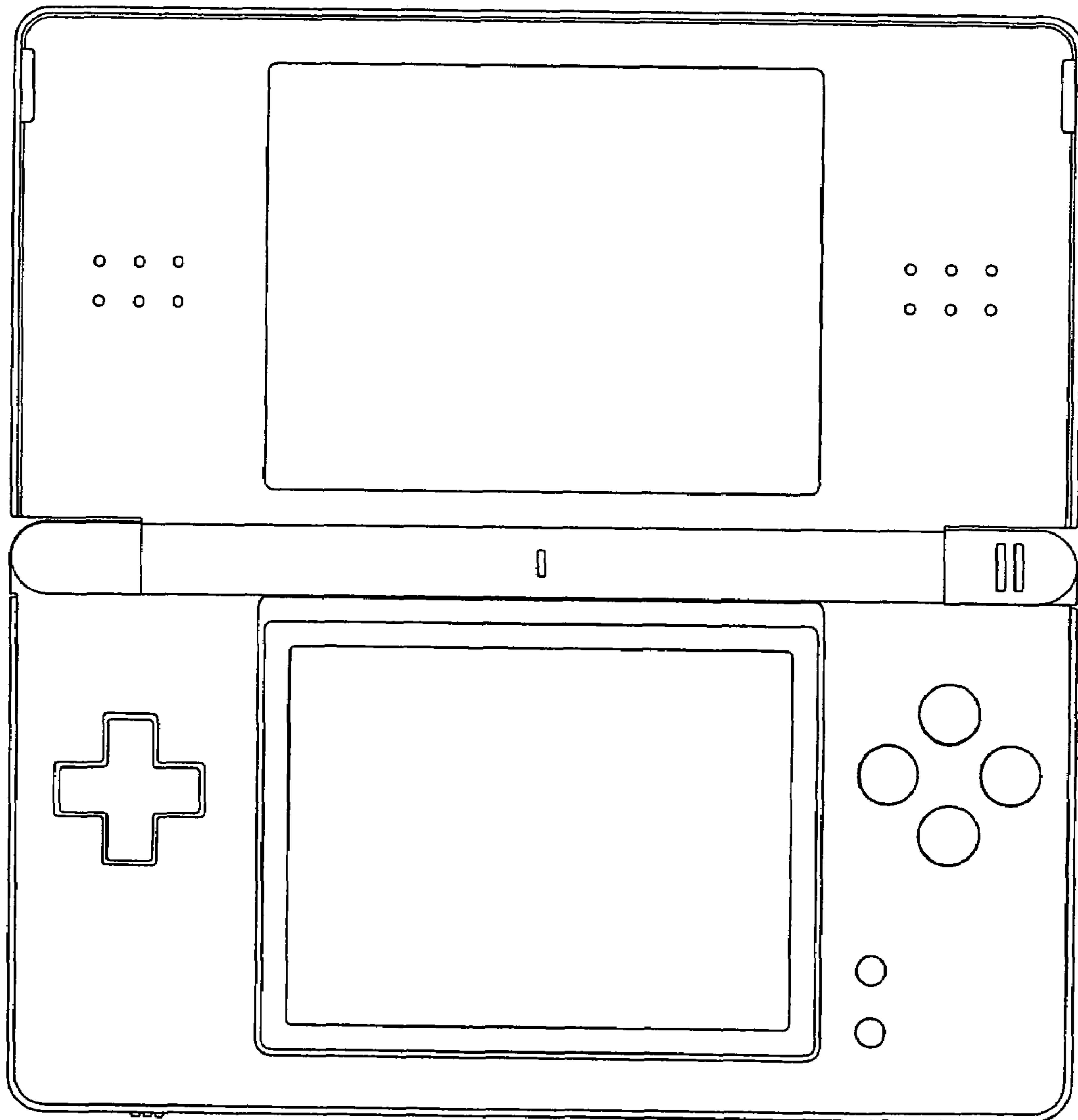

FIG. 4

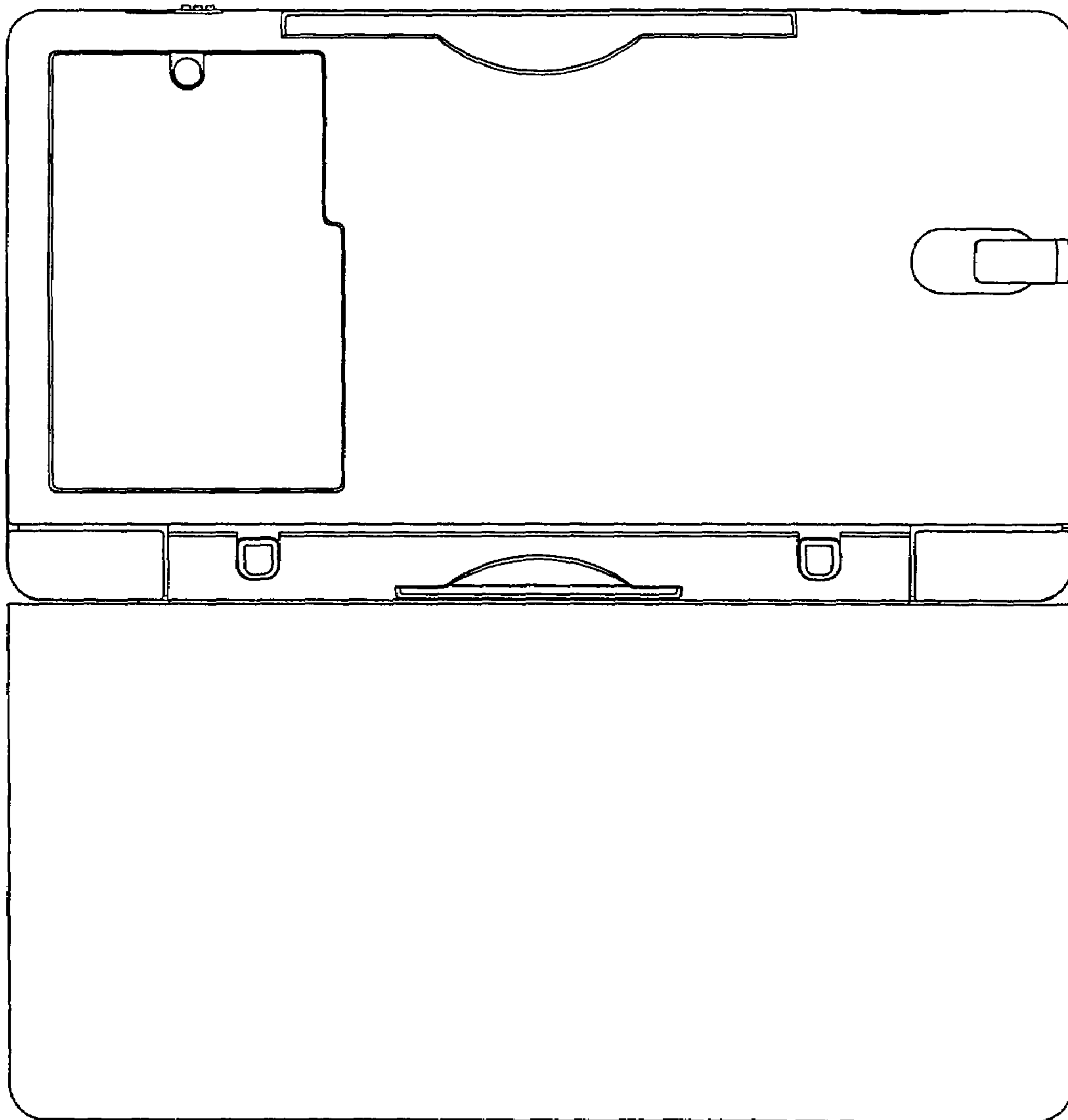

FIG. 5

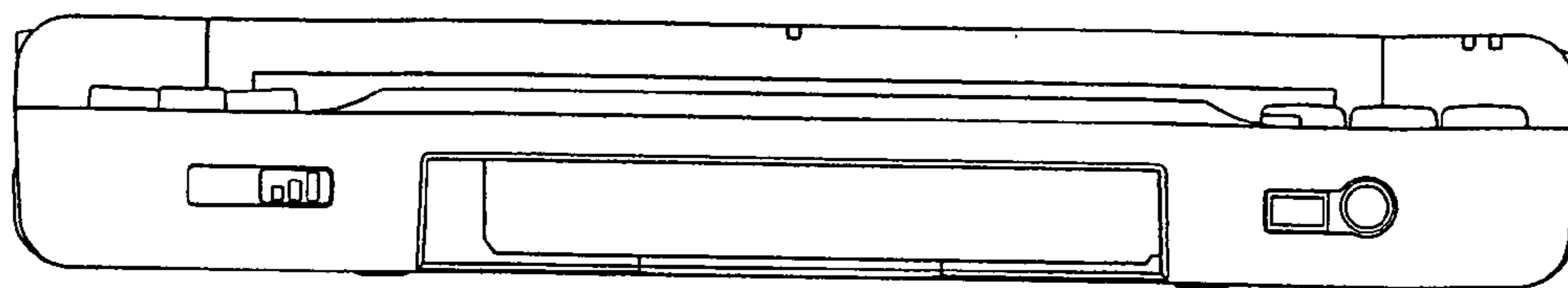

FIG. 6

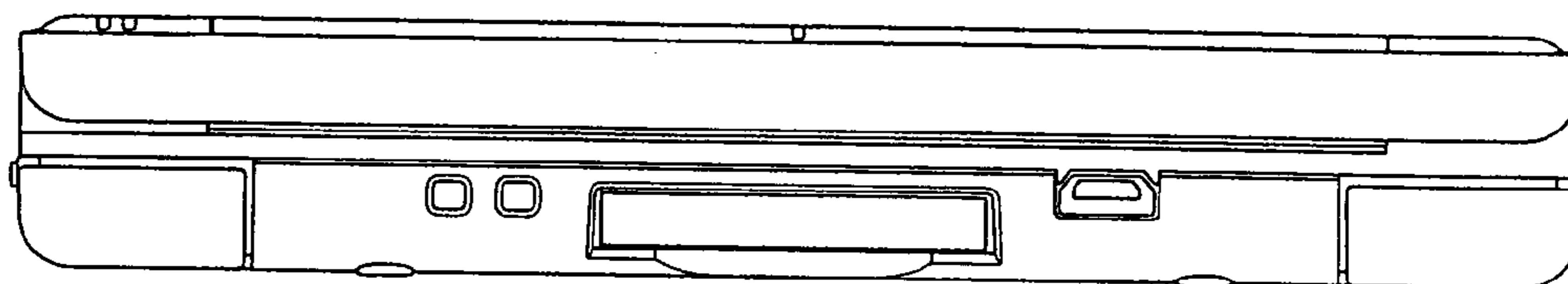

FIG. 7

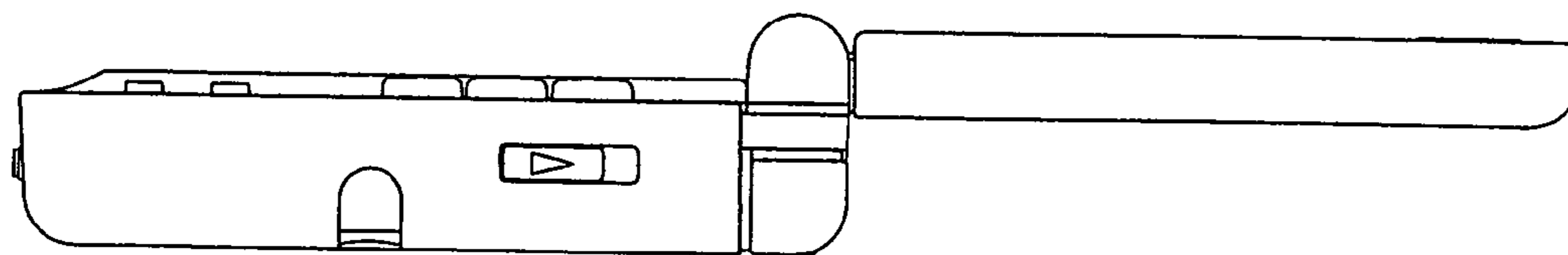

FIG. 8

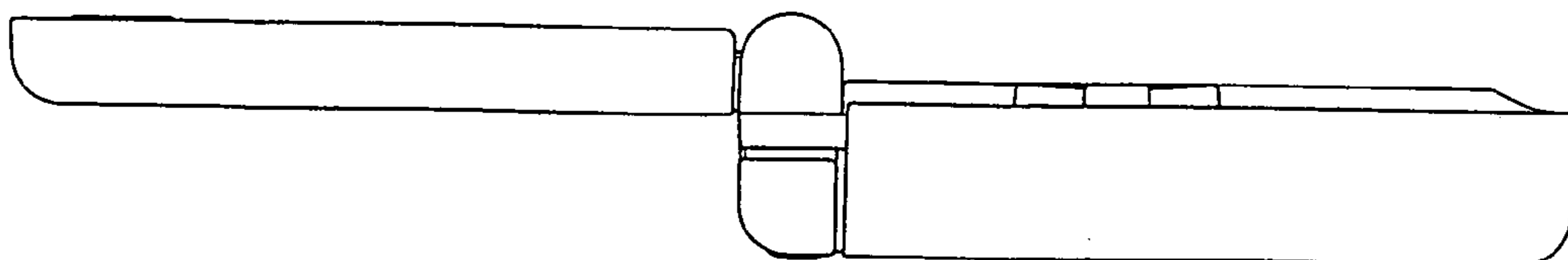

FIG. 9

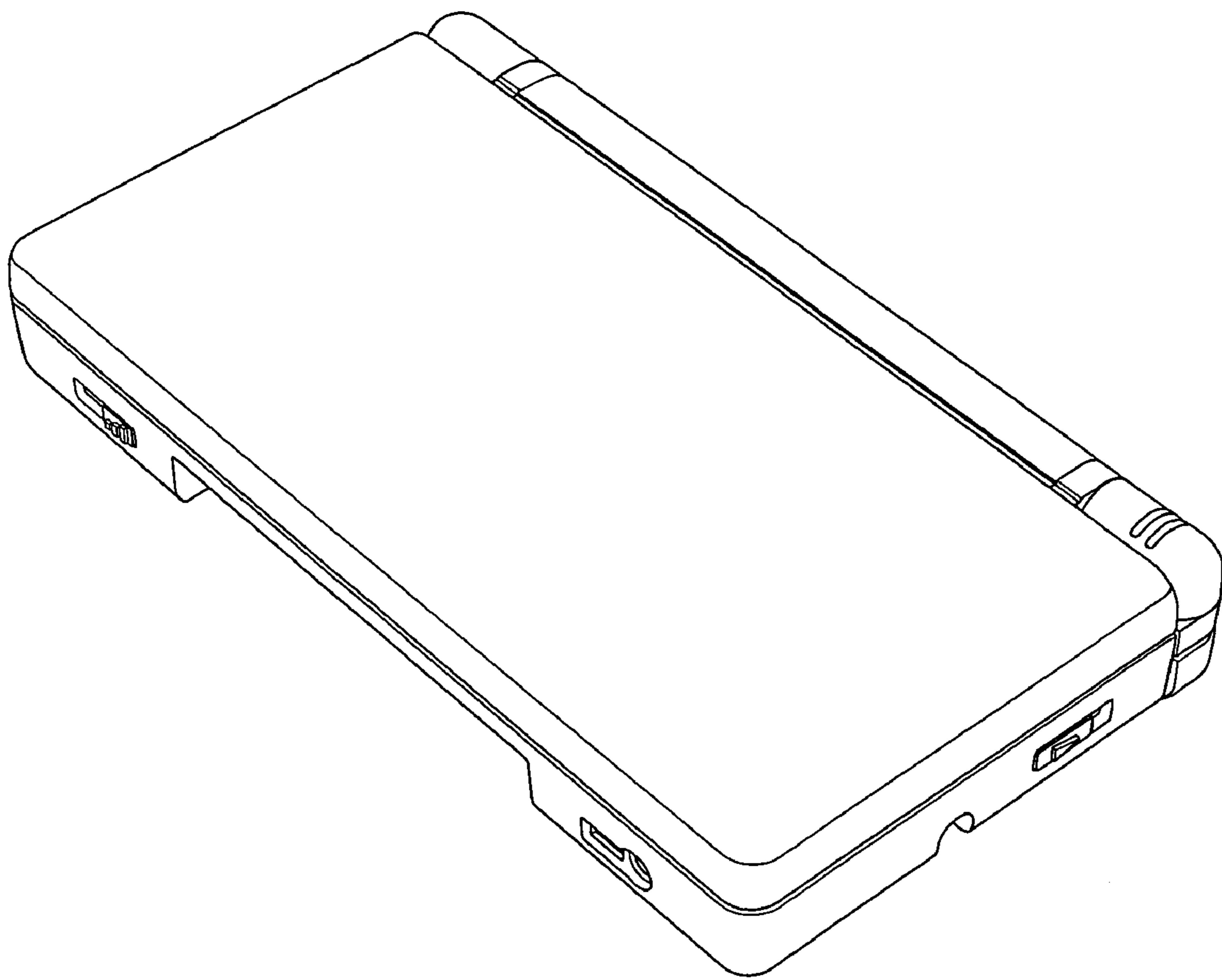

FIG. 10

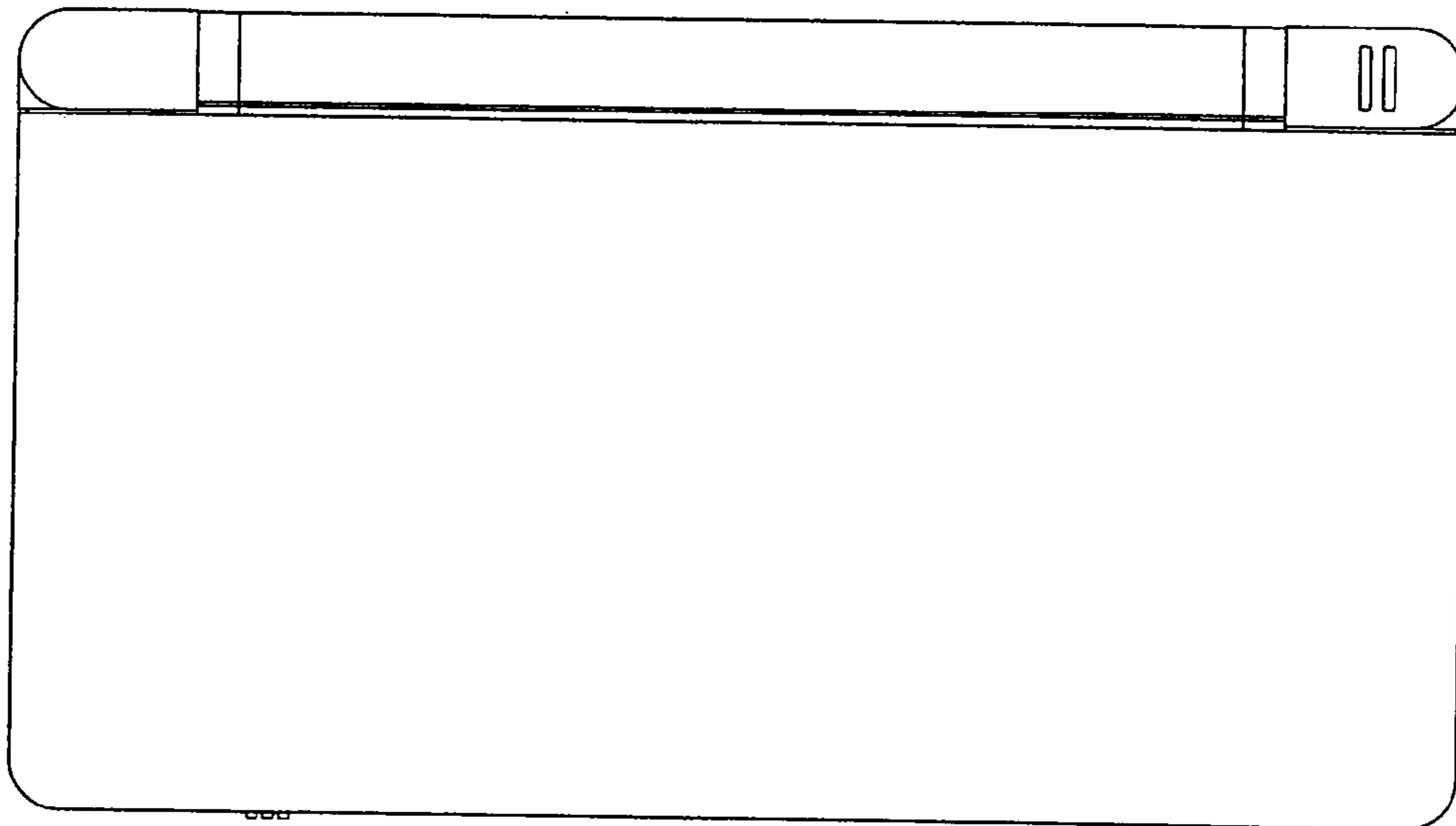

FIG. 11

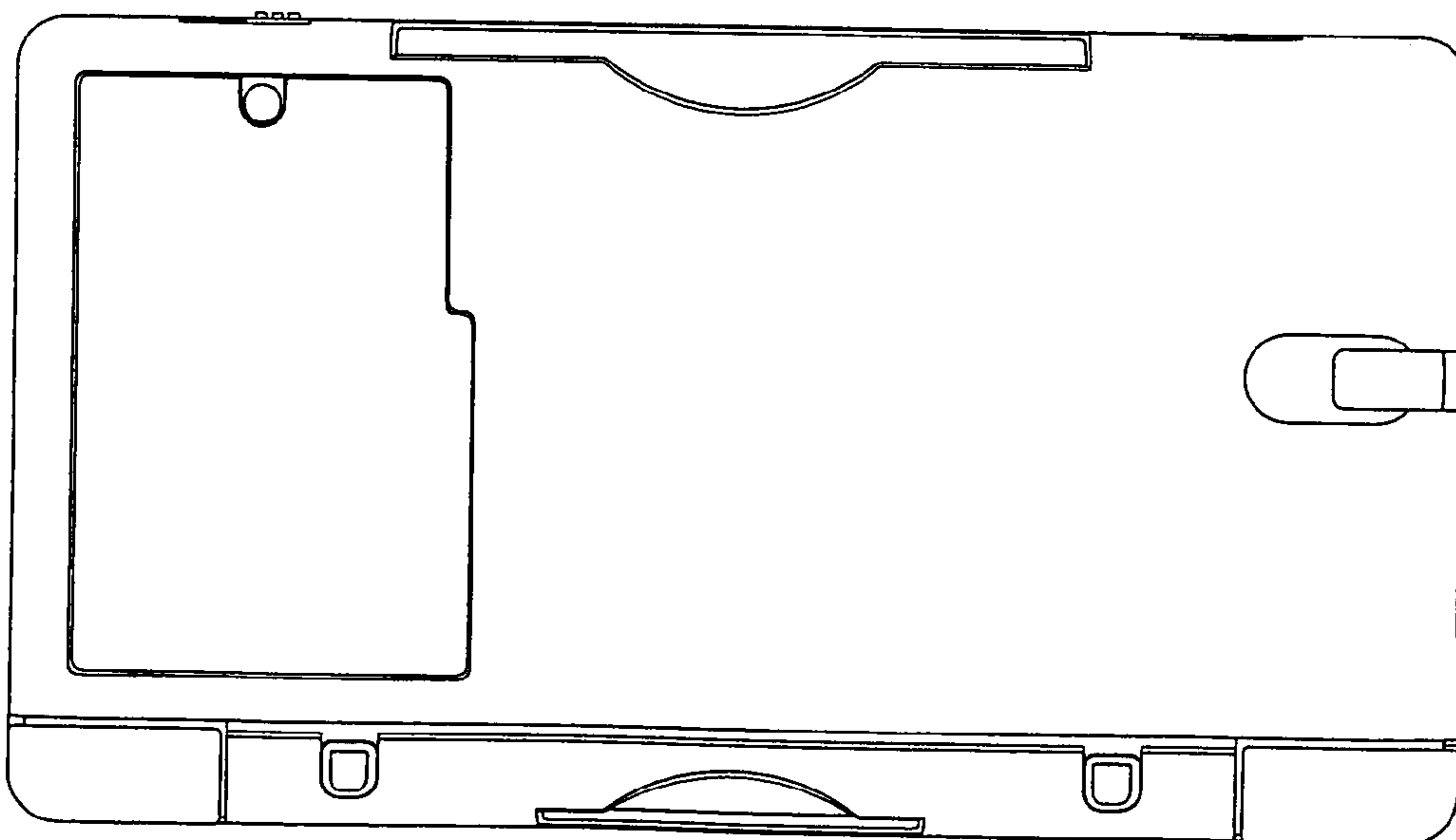

FIG. 12

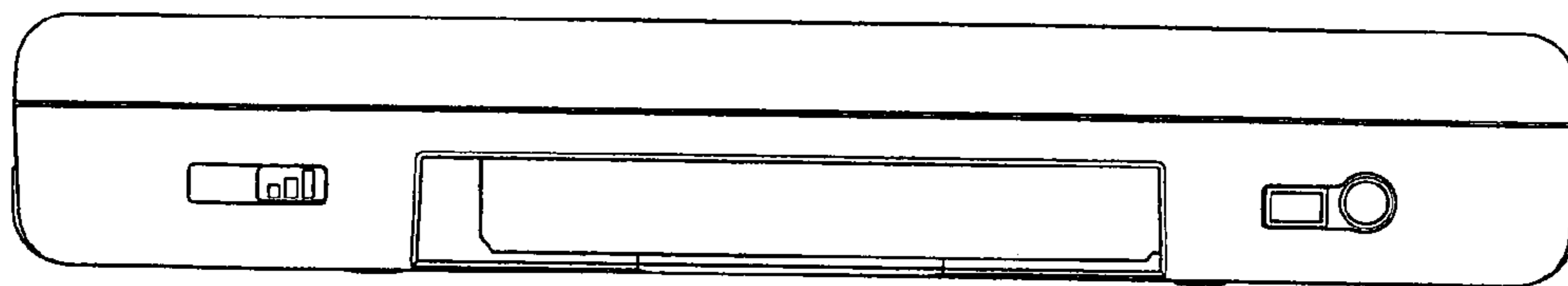

FIG. 13

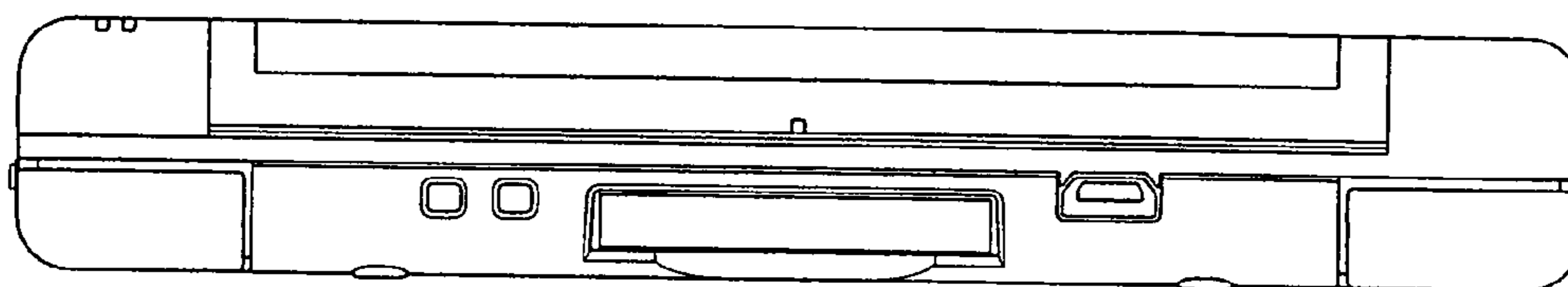

FIG. 14

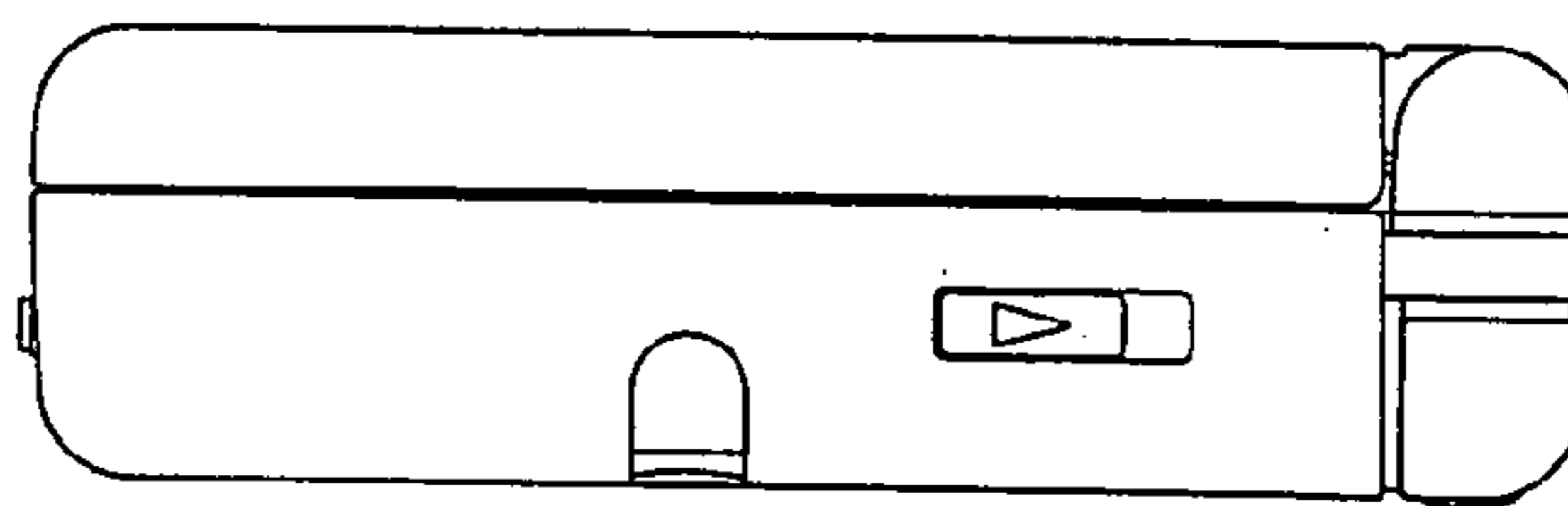

FIG. 15

