



US00D554090S

(12) **United States Design Patent**  
**Hunt et al.**

(10) **Patent No.:** **US D554,090 S**

(45) **Date of Patent:** **\*\* Oct. 30, 2007**

(54) **PORTABLE COMMUNICATIONS DEVICE**

(75) Inventors: **Charles Hunt**, Wake Forest, NC (US);  
**Christopher Collins**, Cary, NC (US)

(73) Assignee: **Sony Ericsson Mobile Communications A.B.**, Lund (SE)

(\*\*) Term: **14 Years**

(21) Appl. No.: **29/216,317**

(22) Filed: **Nov. 1, 2004**

(51) **LOC (8) Cl.** ..... **14-03**

(52) **U.S. Cl.** ..... **D14/138**

(58) **Field of Classification Search** ..... D14/191,  
D14/138, 147-148, 247-248, 144, 496, 156,  
D14/341-347; 379/433.01-433.13; 455/575.3,  
455/566, 575.1, 556.1, 556.2, 90.3; D21/517;  
D16/208

See application file for complete search history.

(56) **References Cited**

**U.S. PATENT DOCUMENTS**

D451,485 S	*	12/2001	Moss	.....	D14/138
D489,699 S	*	5/2004	Hwang et al.	.....	D14/138
D492,275 S	*	6/2004	Lin et al.	.....	D14/138
D496,016 S	*	9/2004	Hoo	.....	D14/138
D497,893 S	*	11/2004	Hwang et al.	.....	D14/138
D500,480 S	*	1/2005	Daw	.....	D14/138

(Continued)

**FOREIGN PATENT DOCUMENTS**

JP 805597 \* 1/1991

**OTHER PUBLICATIONS**

Sony Ericsson Z530 telephone, announced Feb. 2006, [online], [retrieved on Sep. 7, 2006]. Retrieved from Internet, <URL:http://www.gsmarena.com>.\*

(Continued)

*Primary Examiner*—Jeffrey Asch

(74) *Attorney, Agent, or Firm*—Myers Bigel Sibley & Sajovec PA

(57) **CLAIM**

The ornamental design for a portable communications device, as shown and described.

**DESCRIPTION**

FIG. 1 is a front perspective view of the portable communications device with a camera in a closed configuration showing our design;

FIG. 2 is front view thereof;

FIG. 3 is a side view thereof;

FIG. 4 is an opposing side view thereof;

FIG. 5 is a rear view thereof;

FIG. 6 is an end view thereof;

FIG. 7 is an opposing end view thereof;

FIG. 8 is a front perspective view of the portable communications device in an open configuration;

FIG. 9 is a front view thereof;

FIG. 10 is a side view thereof;

FIG. 11 is an opposing side view thereof;

FIG. 12 is a rear view thereof;

FIG. 13 is a side and rear perspective view of a second embodiment of the portable communications device shown in FIGS. 1-12, the only difference over the first embodiment being that the replacement covers are shaded to indicate a contrasting surface treatment;

FIG. 14 is a side view thereof;

FIG. 15 is an opposing side view thereof; and,

FIG. 16 is a rear view thereof.

The broken lines shown herein are for illustrative purposes only and form no part of the claimed design. The stippled shading shown in the embodiment of FIG. 13 indicates an ornamental contrasting color or pattern. The illustrated device is not limited to the scale shown.

**1 Claim, 10 Drawing Sheets**

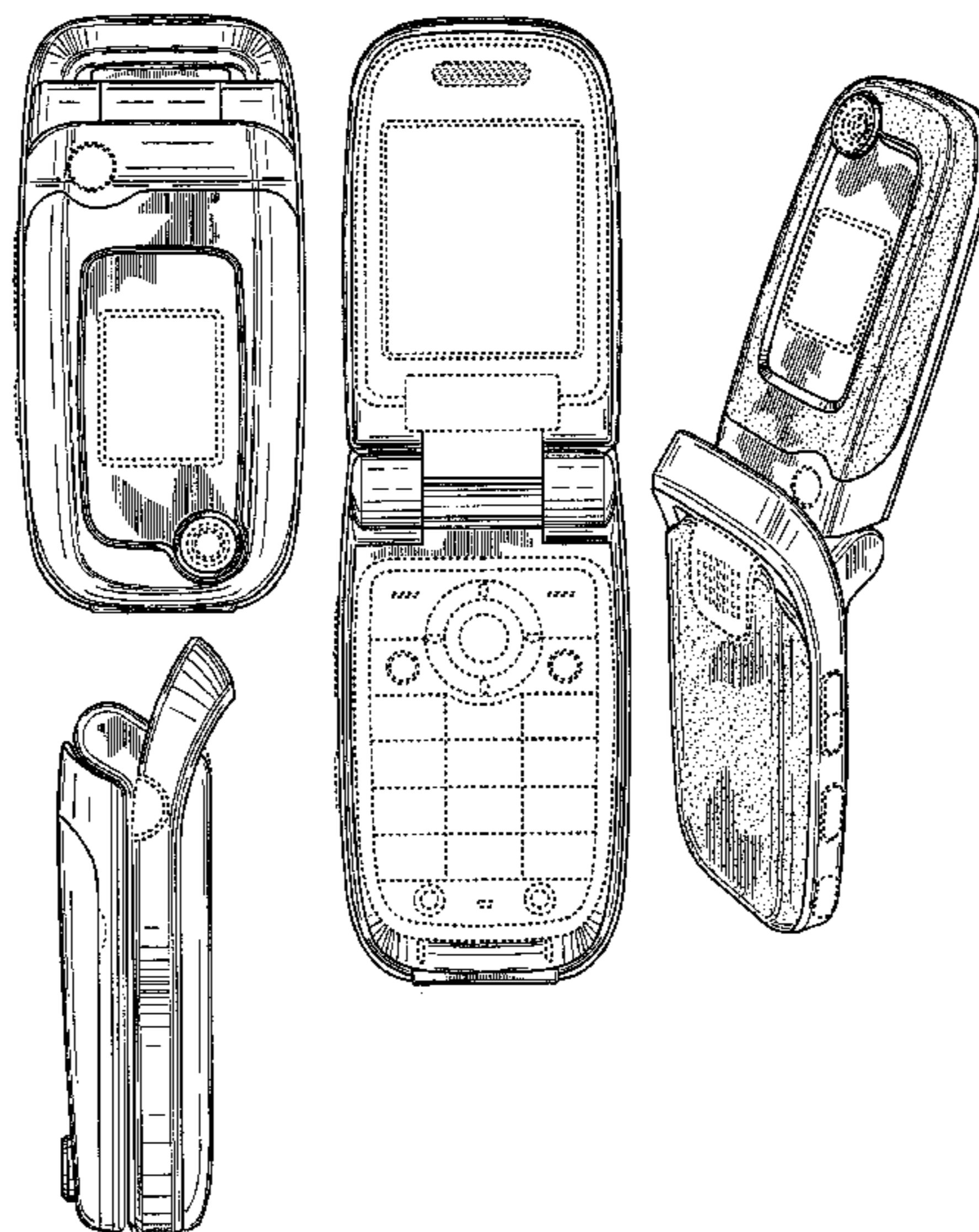

U.S. PATENT DOCUMENTS

D501,455	S	*	2/2005	Hunt et al.	.....	D14/138
D502,161	S	*	2/2005	Kim et al.	.....	D14/138
D502,457	S	*	3/2005	Eigenstetter et al.	.....	D14/138
D502,459	S	*	3/2005	Lee et al.	.....	D14/138
D507,553	S	*	7/2005	Gotou et al.	.....	D14/138
D508,475	S	*	8/2005	Wu et al.	.....	D14/138
D510,078	S	*	9/2005	Lee et al.	.....	D14/138
D510,079	S	*	9/2005	Kim et al.	.....	D14/138
D513,505	S	*	1/2006	Lee	.....	D14/138
D515,543	S	*	2/2006	Shintani	.....	D14/138
D516,532	S	*	3/2006	Hunt et al.	.....	D14/138
D518,012	S	*	3/2006	Fuxen	.....	D14/138
D518,013	S	*	3/2006	Fuxen	.....	D14/138
D519,486	S	*	4/2006	Lee et al.	.....	D14/138
D519,967	S	*	5/2006	Wei et al.	.....	D14/138
D520,486	S	*	5/2006	Kim et al.	.....	D14/138
D520,981	S	*	5/2006	Lee et al.	.....	D14/138
D521,970	S	*	5/2006	Han et al.	.....	D14/138
D523,833	S	*	6/2006	Koh et al.	.....	D14/138
D524,787	S	*	7/2006	Watanabe et al.	.....	D14/138
D526,987	S	*	8/2006	Lee et al.	.....	D14/138
2004/0110540	A1	*	6/2004	Sato et al.	.....	455/566
2005/0075082	A1	*	4/2005	Iwai et al.	.....	455/90.3
2005/0186985	A1	*	8/2005	Im et al.	.....	455/550.1
2006/0121961	A1	*	6/2006	Cho	.....	455/575.3

OTHER PUBLICATIONS

Samsung X660 telephone, announced 4th quarter 2005, [online], [retrieved on Aug. 25, 2006]. Retrieved from Internet ,<URL:http://www.gsmarena.com>.\*

Motorola A668 telephone, announced 4th quarter 2004, [online], [retrieved on Aug. 29, 2006]. Retrieved from Internet ,<URL:http://www.gsmarena.com>.\*

VK Mobile VK3100 telephone, announced 4th quarter 2005, [online], [retrieved on Aug. 29, 2006]. Retrieved from Internet ,<URL:http://www.gsmarena.com>.\*

Sony Ericsson Z520 telephone, announced Jun. 2005, [online], [retrieved on Sep. 7, 2006]. Retrieved from Internet , <URL:http://www.gsmarena.com>.\*

Siemens CF62 telephone, announced Feb. 2004, [online], [retrieved on Sep. 4, 2006]. Retrieved from Internet , <URL:http://www.gsmarena.com>.\*

Sony Ericsson Z200 telephone, announced 3<sup>rd</sup> quarter 2003, [online], [retrieved on Sep. 7, 2006]. Retrieved from Internet , <URL:http://www.gsmarena.com>.\*

Siemens CF76 telephone, announced 1<sup>st</sup> quarter 2005, [online], [retrieved on Jul. 23, 2006]. Retrieved from Internet , <URL:http://www.gsmarena.com>.\*

Orly Michael, *Siemens CF62T Review*, www.mobileburn.com, 10 pages, printed Sep. 13, 2004.

Z200, www.sonyericsson.com, 5 pages, Date Unknown but believed to be before Nov. 2004.

\* cited by examiner

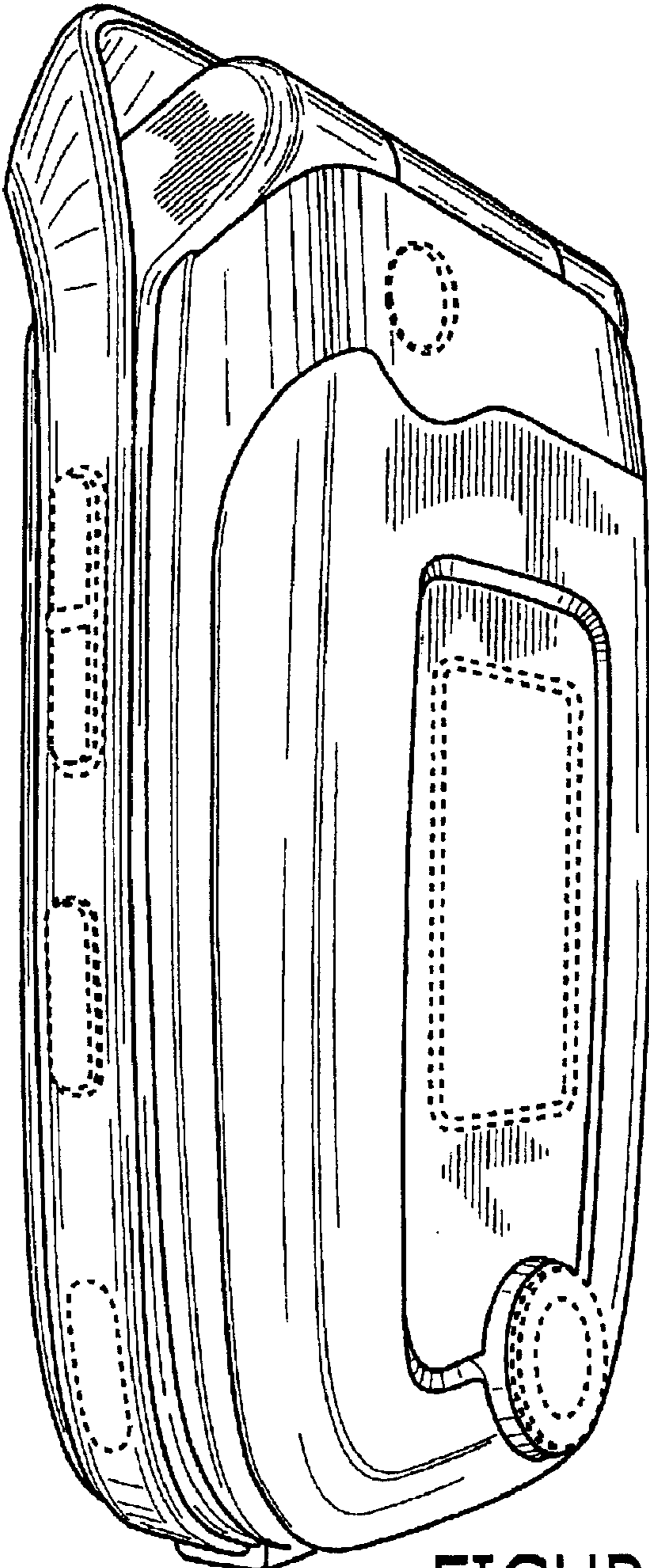

FIGURE 1

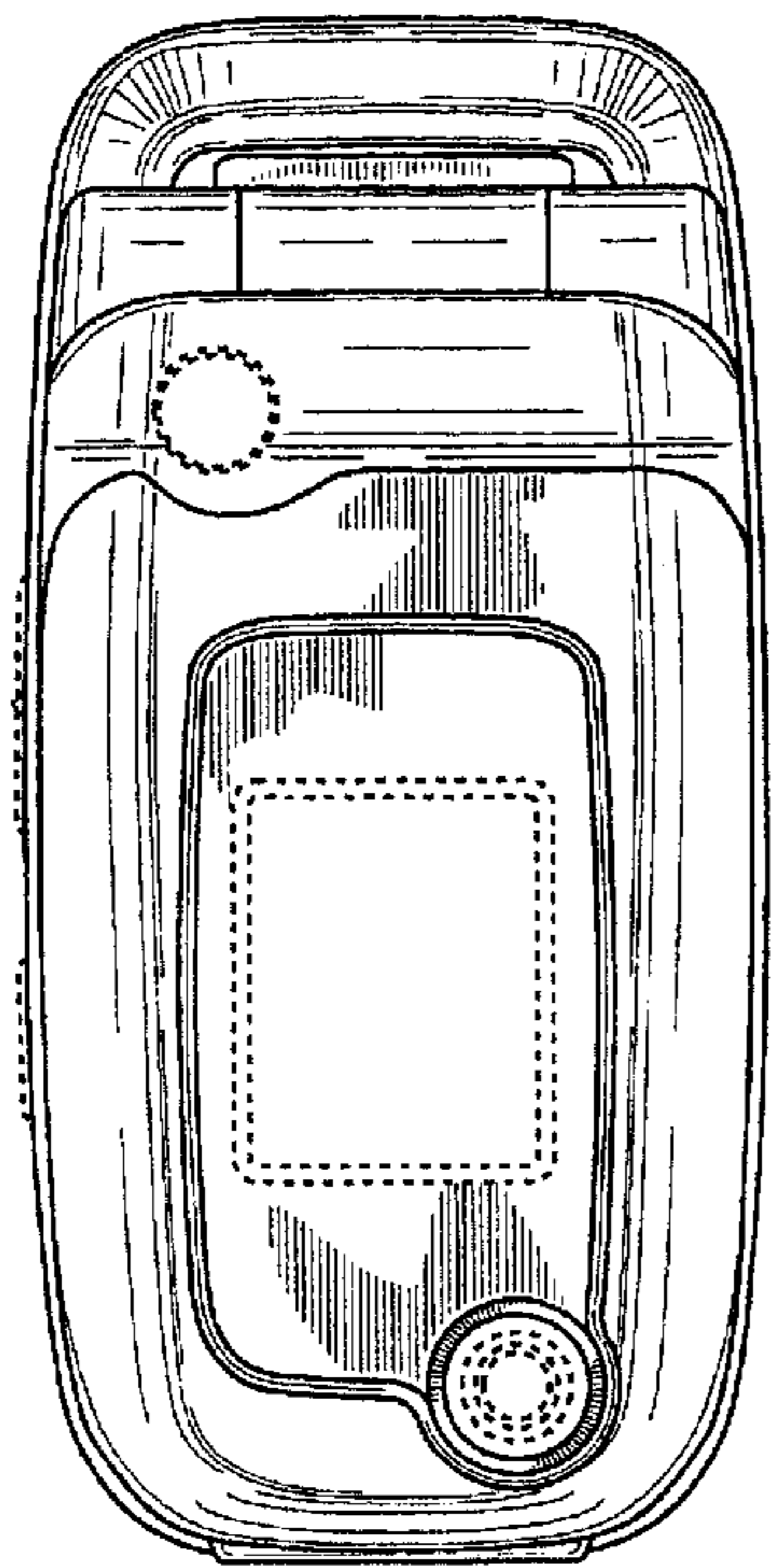

FIGURE 2

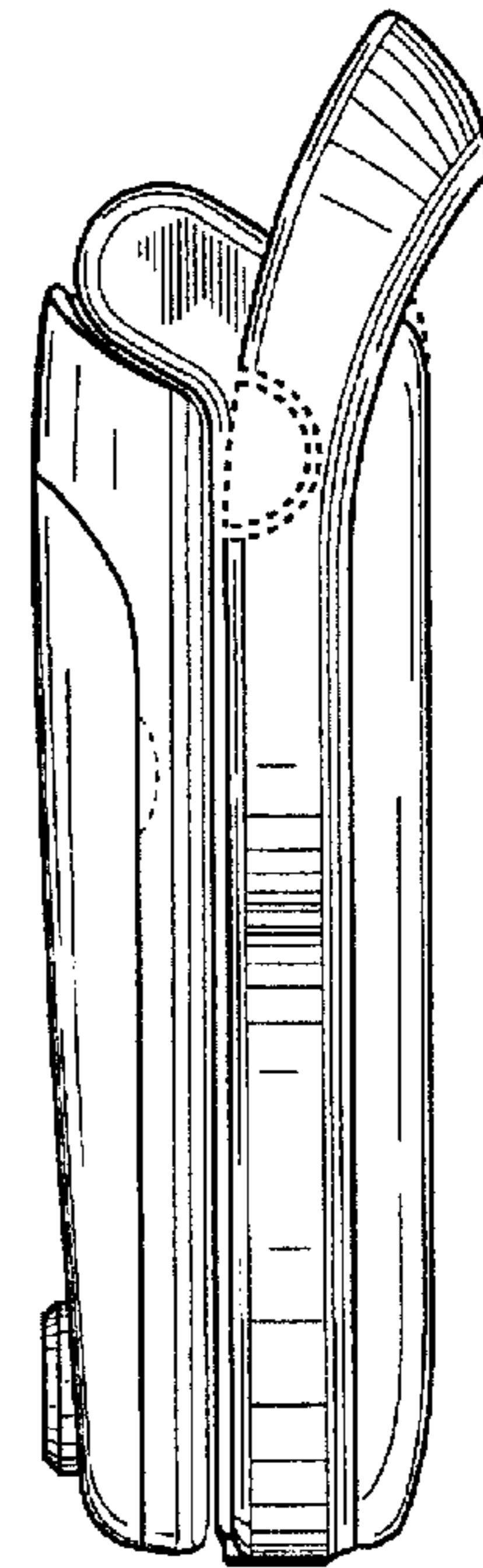

FIGURE 3

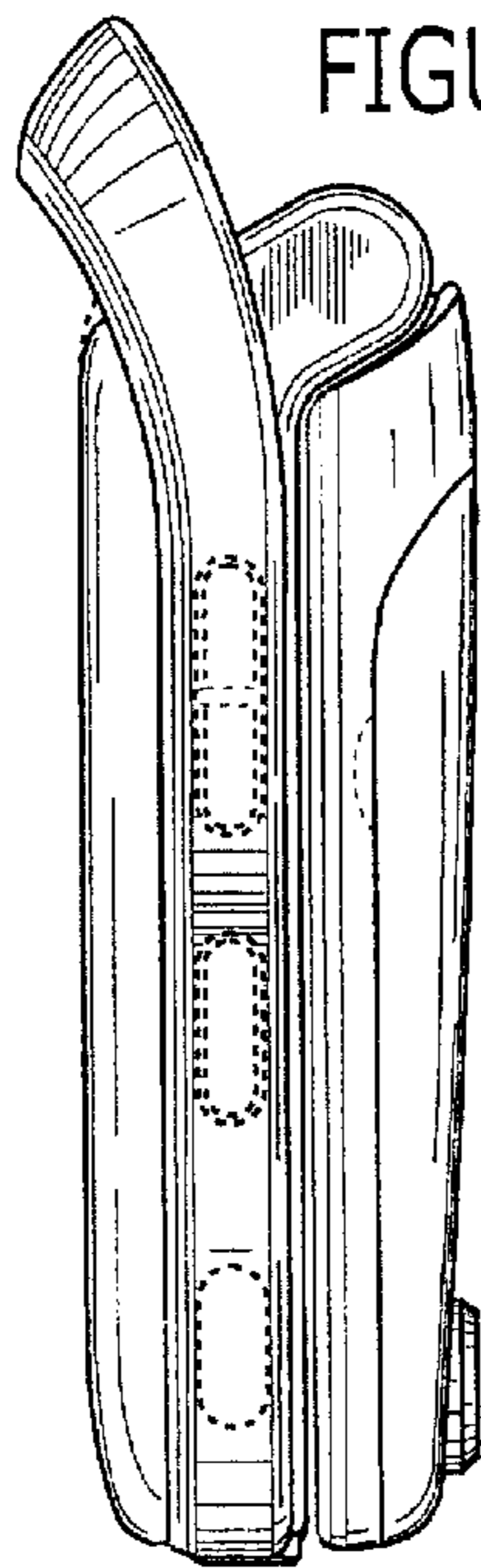

FIGURE 4

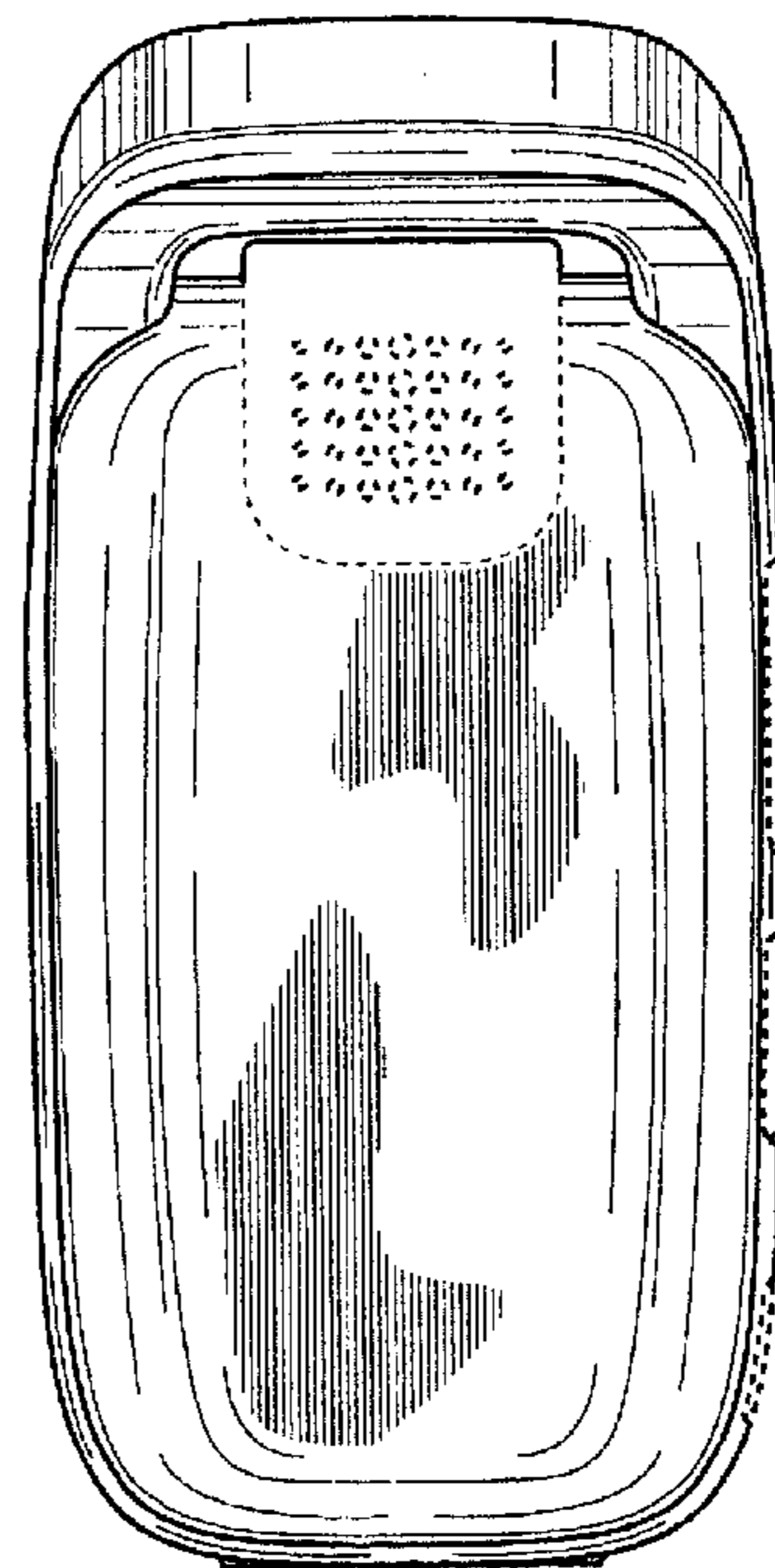

FIGURE 5

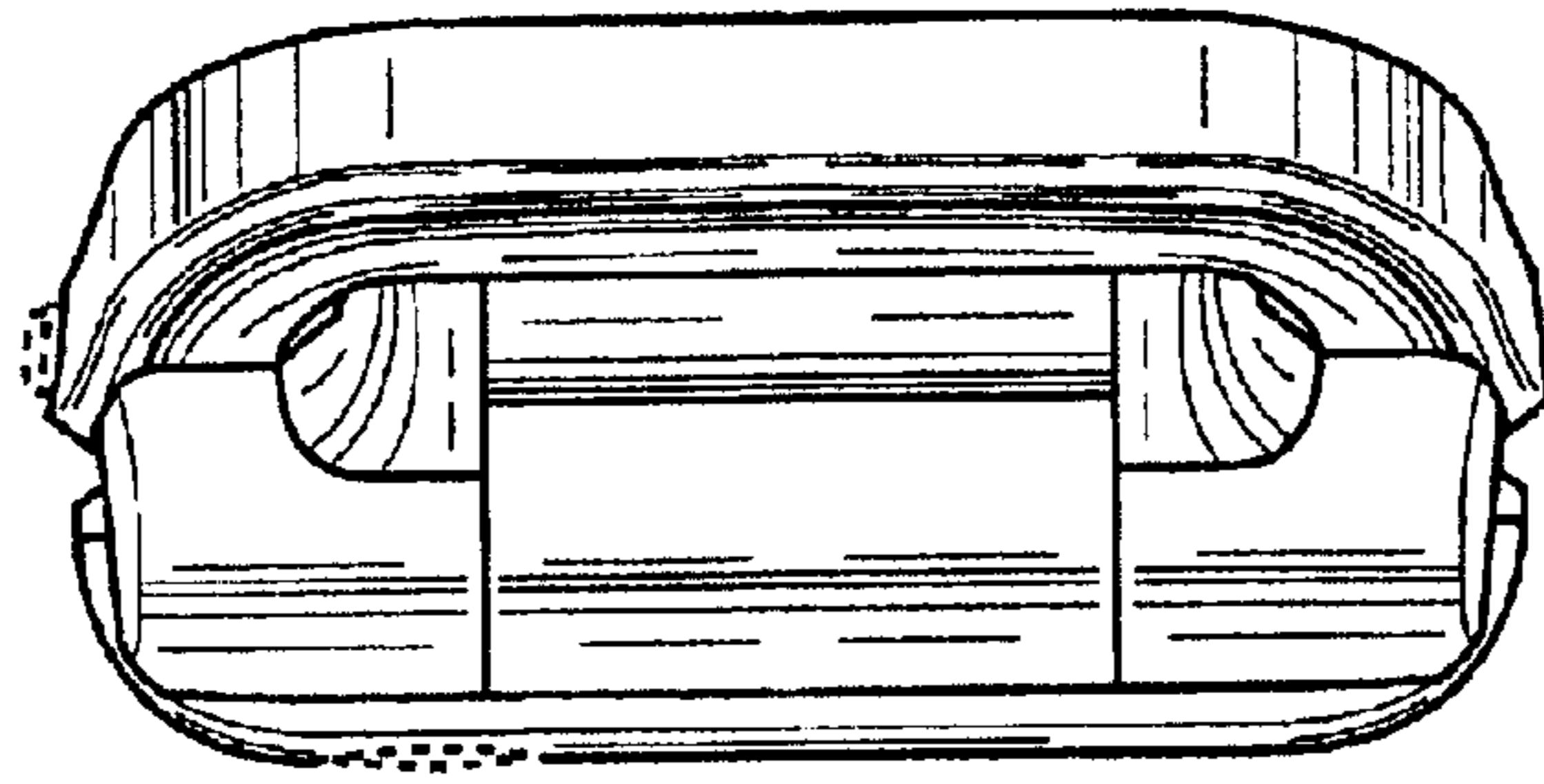

FIGURE 6

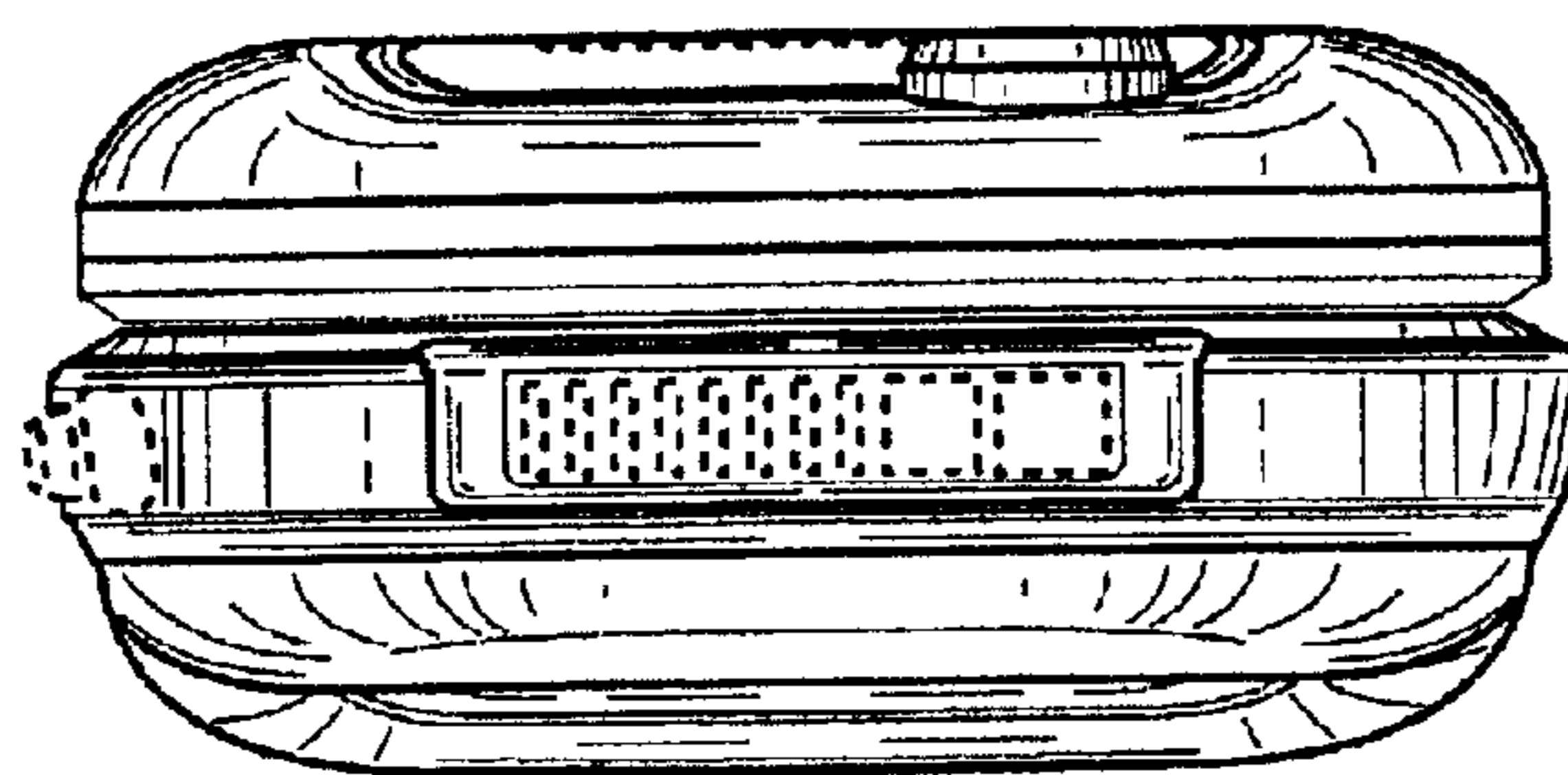

FIGURE 7

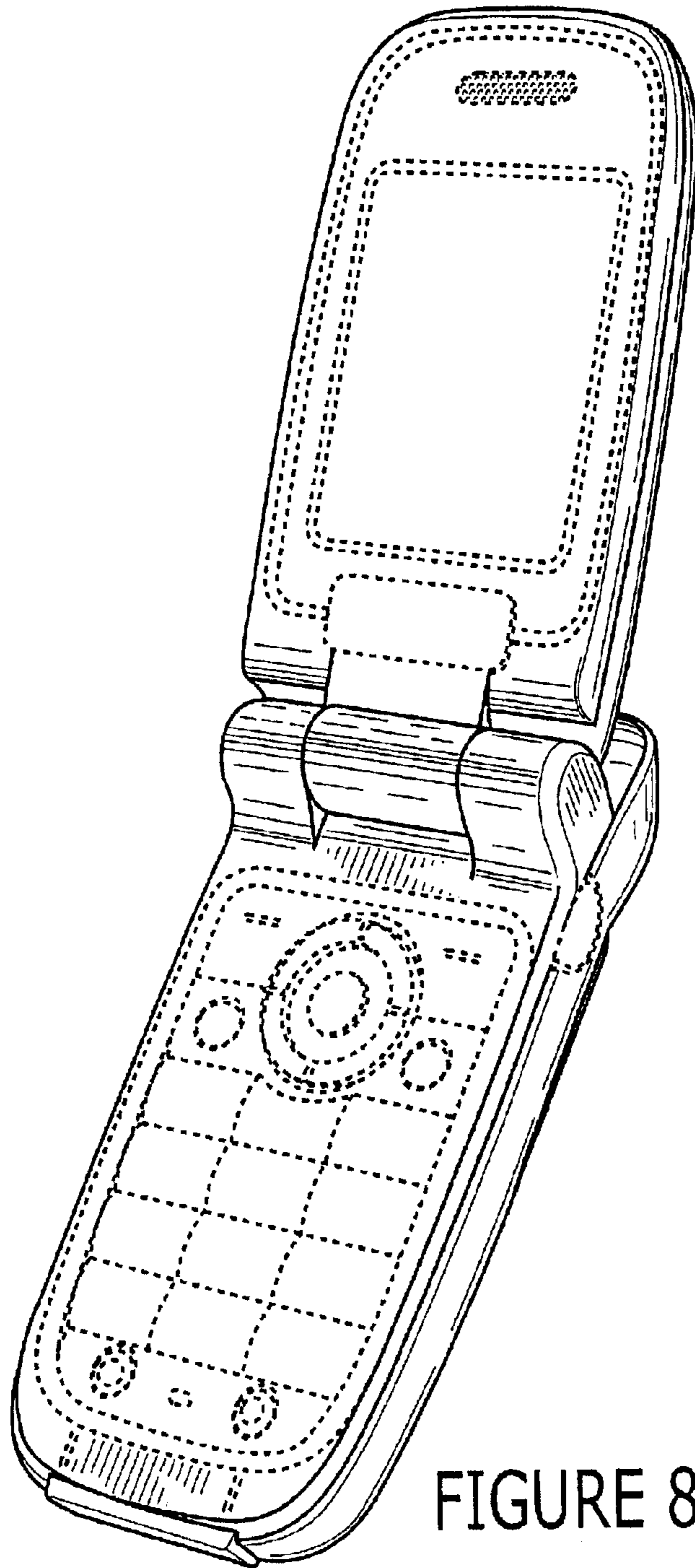

FIGURE 8

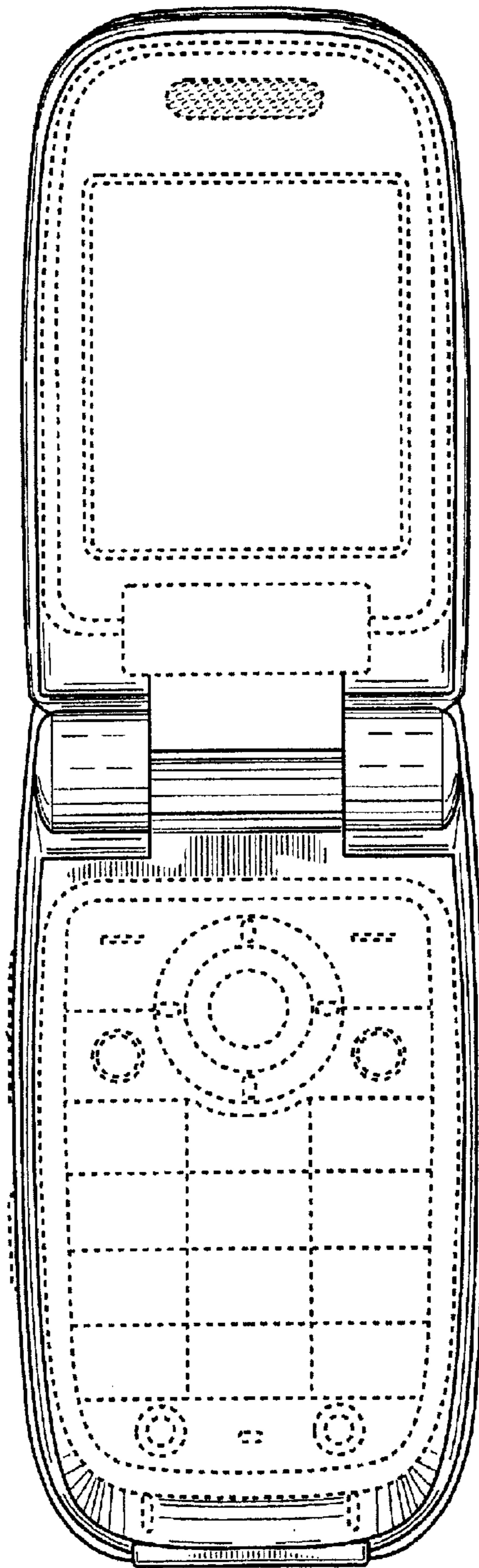
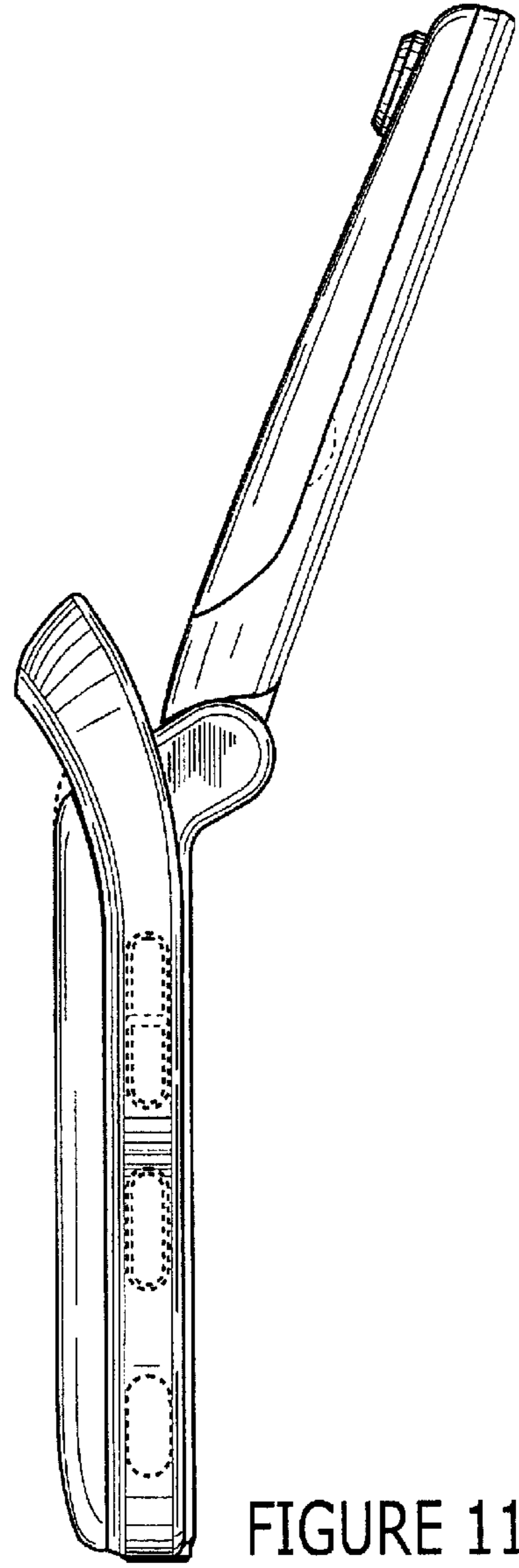
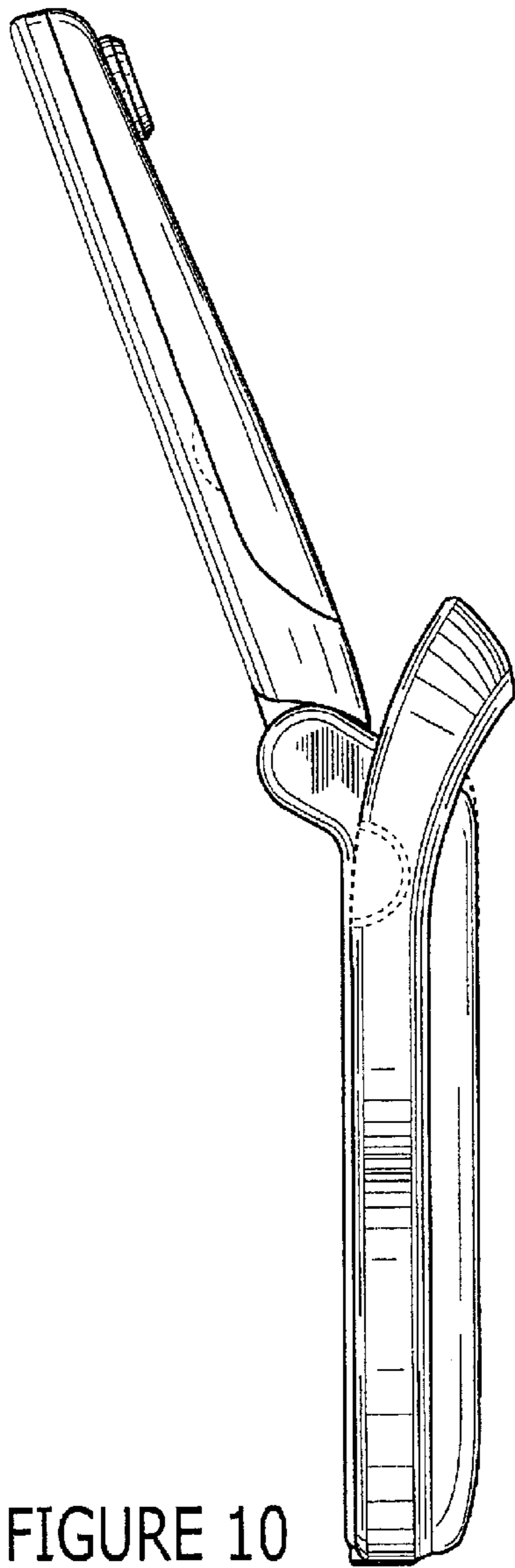

FIGURE 9





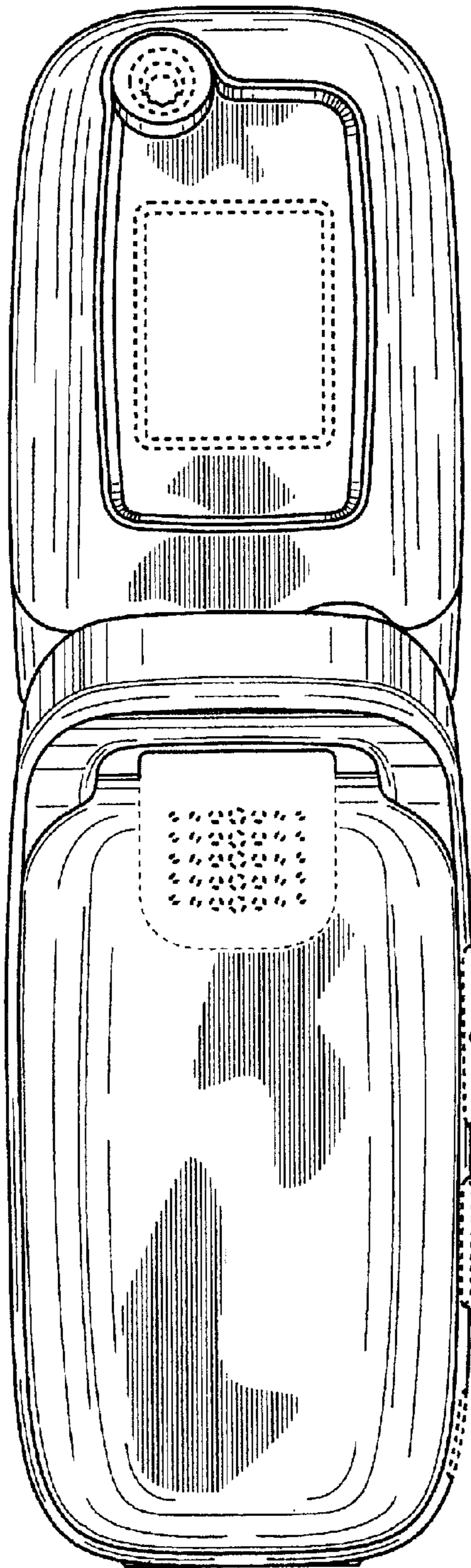

FIGURE 12

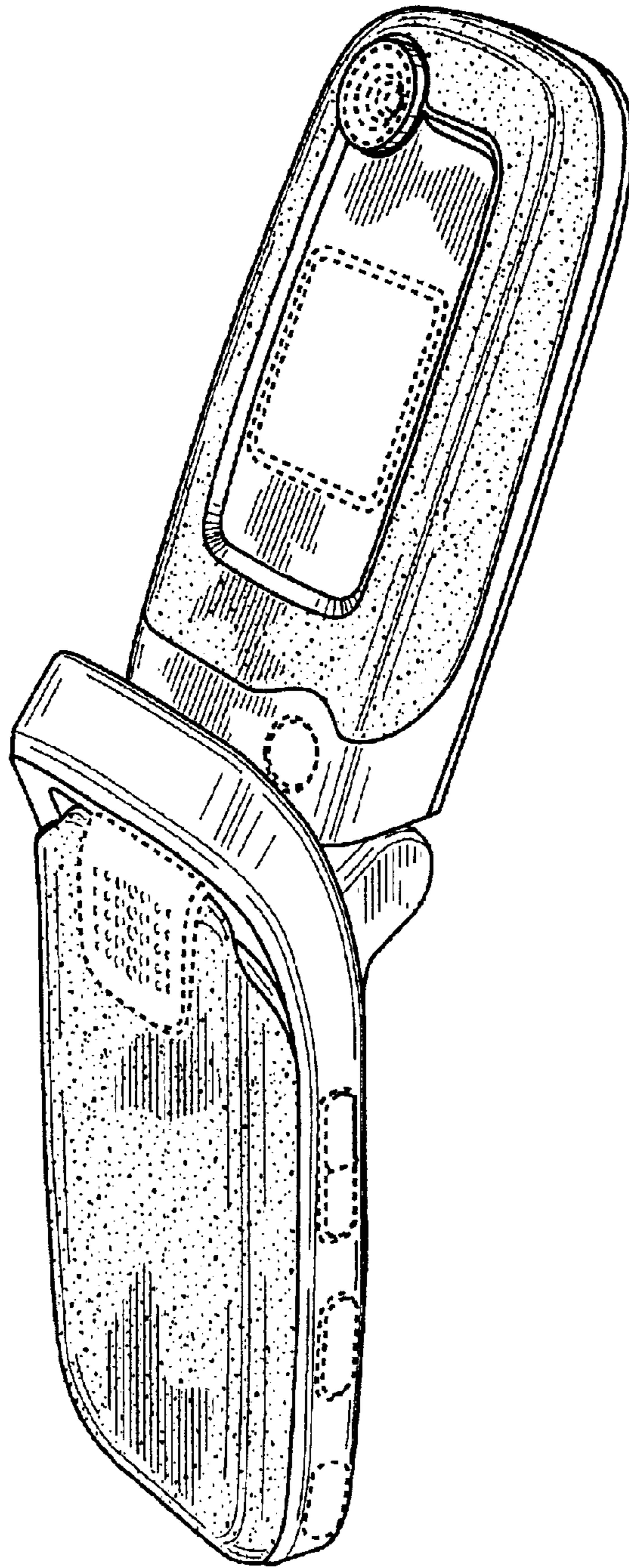
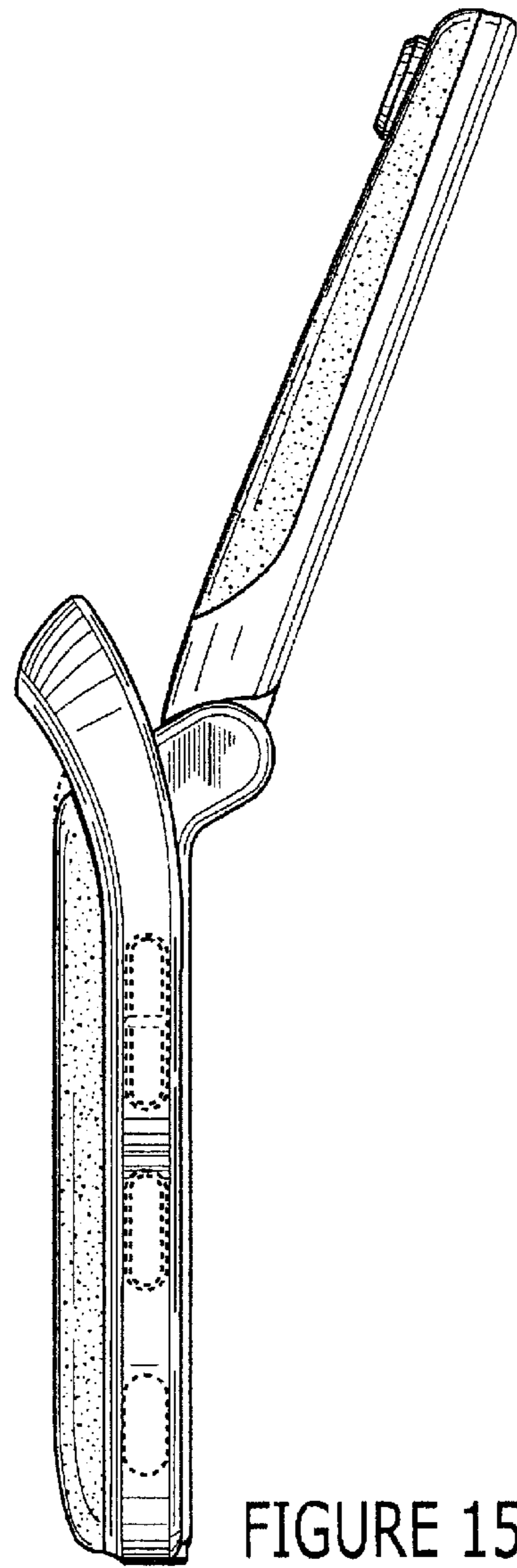
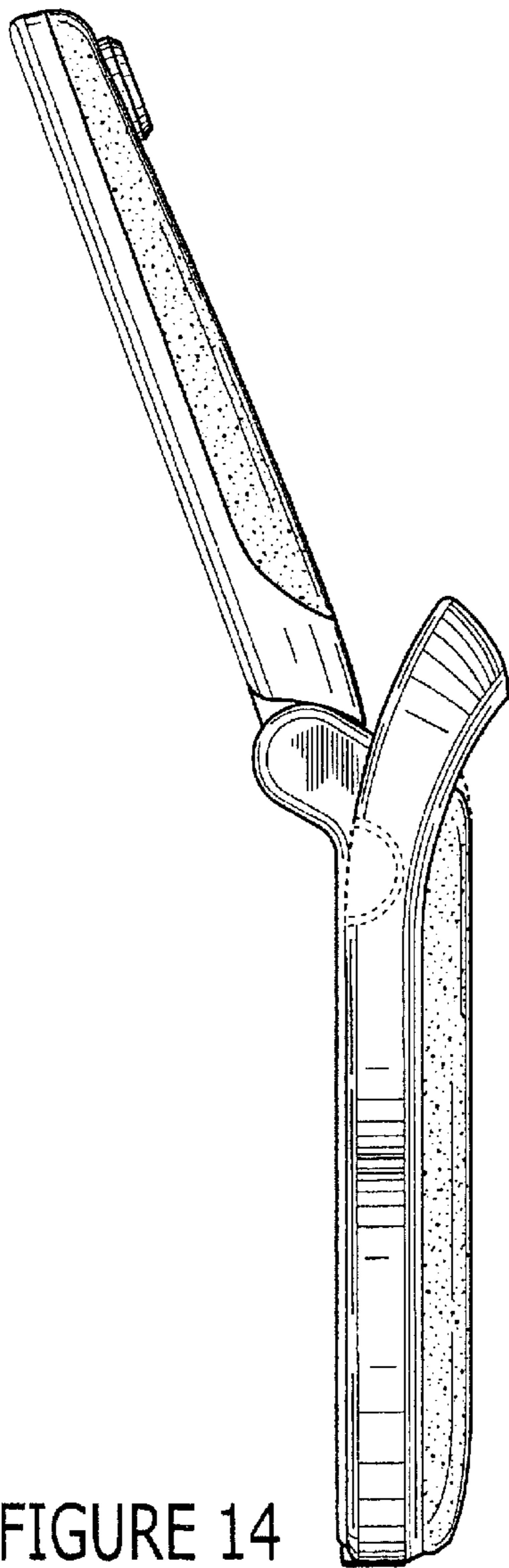

FIGURE 13



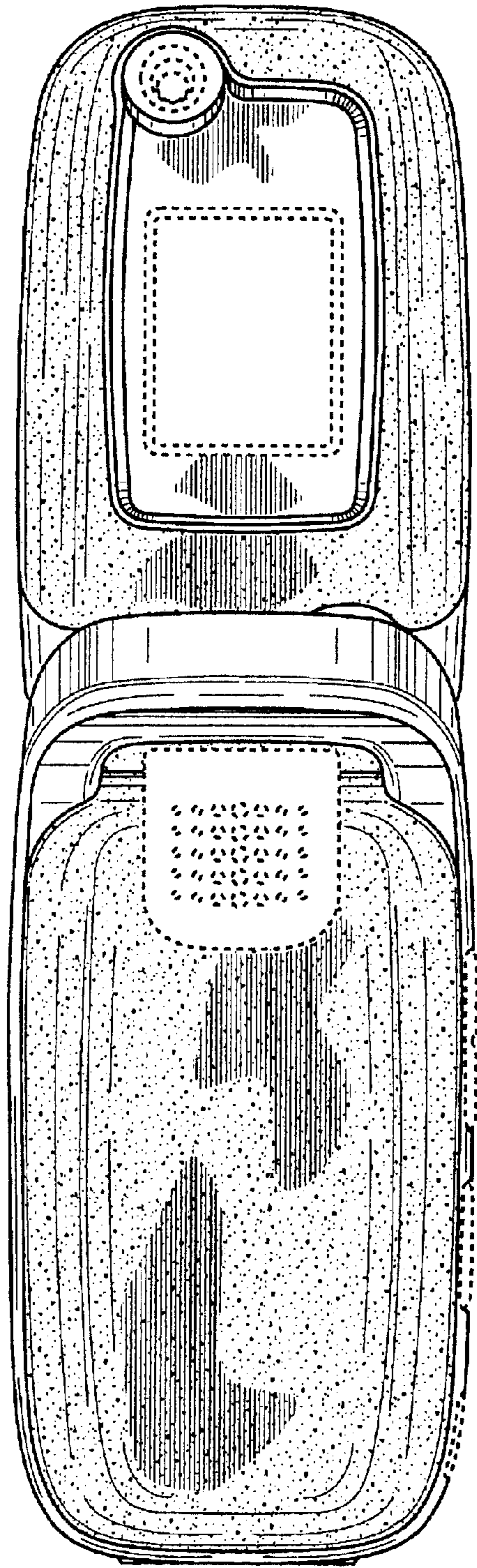

FIGURE 16