



US00D554088S

(12) **United States Design Patent**
Matsumoto

(10) **Patent No.:** **US D554,088 S**

(45) **Date of Patent:** **** Oct. 30, 2007**

(54) **DIGITAL DISC PLAYER**

(75) Inventor: **Yasuhiko Matsumoto**, Komae (JP)

(73) Assignee: **Clarion Co., Ltd.**, Tokyo (JP)

(**) Term: **14 Years**

(21) Appl. No.: **29/263,803**

(22) Filed: **Jul. 31, 2006**

(51) **LOC (8) Cl.** **14-01**

(52) **U.S. Cl.** **D14/136**

(58) **Field of Classification Search** D14/135-136,
D14/156-157, 257-258, 198, 188, 496; 360/99.02,
360/99.07; 369/75.11, 75.21, 77.21, 77.11;
720/612, 619, 647, 655; 455/344, 347-351
See application file for complete search history.

(56) **References Cited**

U.S. PATENT DOCUMENTS

D400,529 S	*	11/1998	Kakizaki	D14/157
D475,691 S	*	6/2003	Nishii et al.	D14/157
D487,448 S	*	3/2004	Sadatsuki	D14/157
D517,035 S	*	3/2006	Sogabe	D14/136

* cited by examiner

Primary Examiner—Nanda Bondade

(74) *Attorney, Agent, or Firm*—Oliff & Berridge, PLC

(57) **CLAIM**

The ornamental design for a digital disc player, as shown and described.

DESCRIPTION

FIG. 1 is a perspective view of a digital disc player;

FIG. 2 is a front view thereof;

FIG. 3 is a rear view thereof;

FIG. 4 is a left-side view thereof;

FIG. 5 is a right-side view thereof;

FIG. 6 is a top view thereof;

FIG. 7 is a bottom view thereof; and,

FIG. 8 is a cross-sectional view taken along the line 8—8 of FIG. 2, with the internal mechanism omitted.

The broken lines are for illustrative purposes only and form no part of the claimed design.

1 Claim, 6 Drawing Sheets

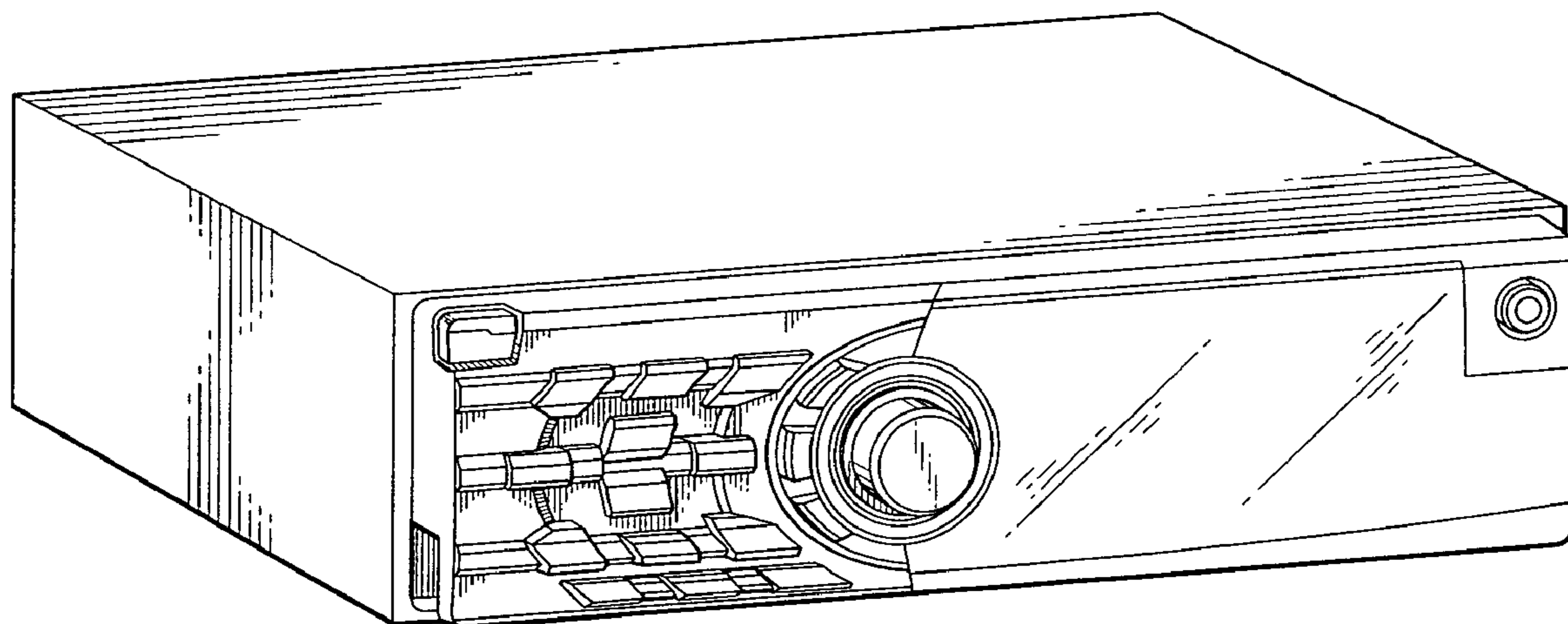

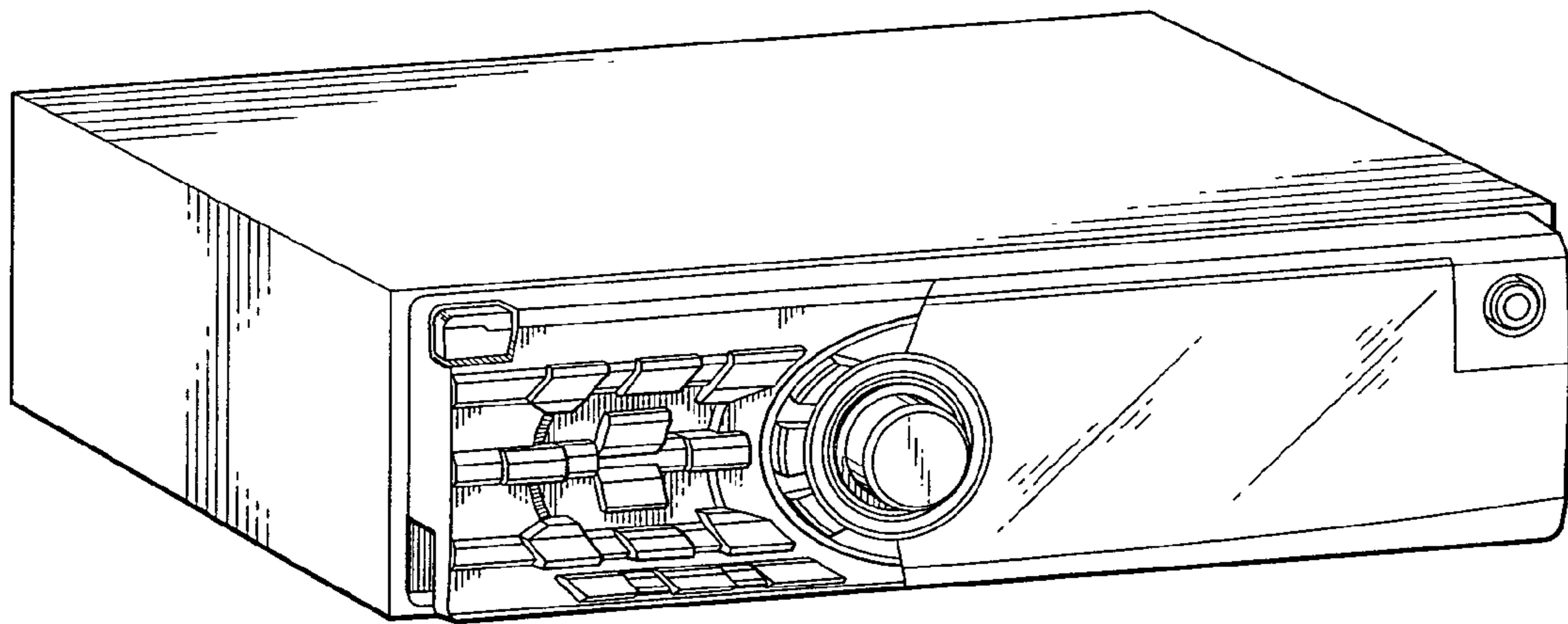

FIG. 1

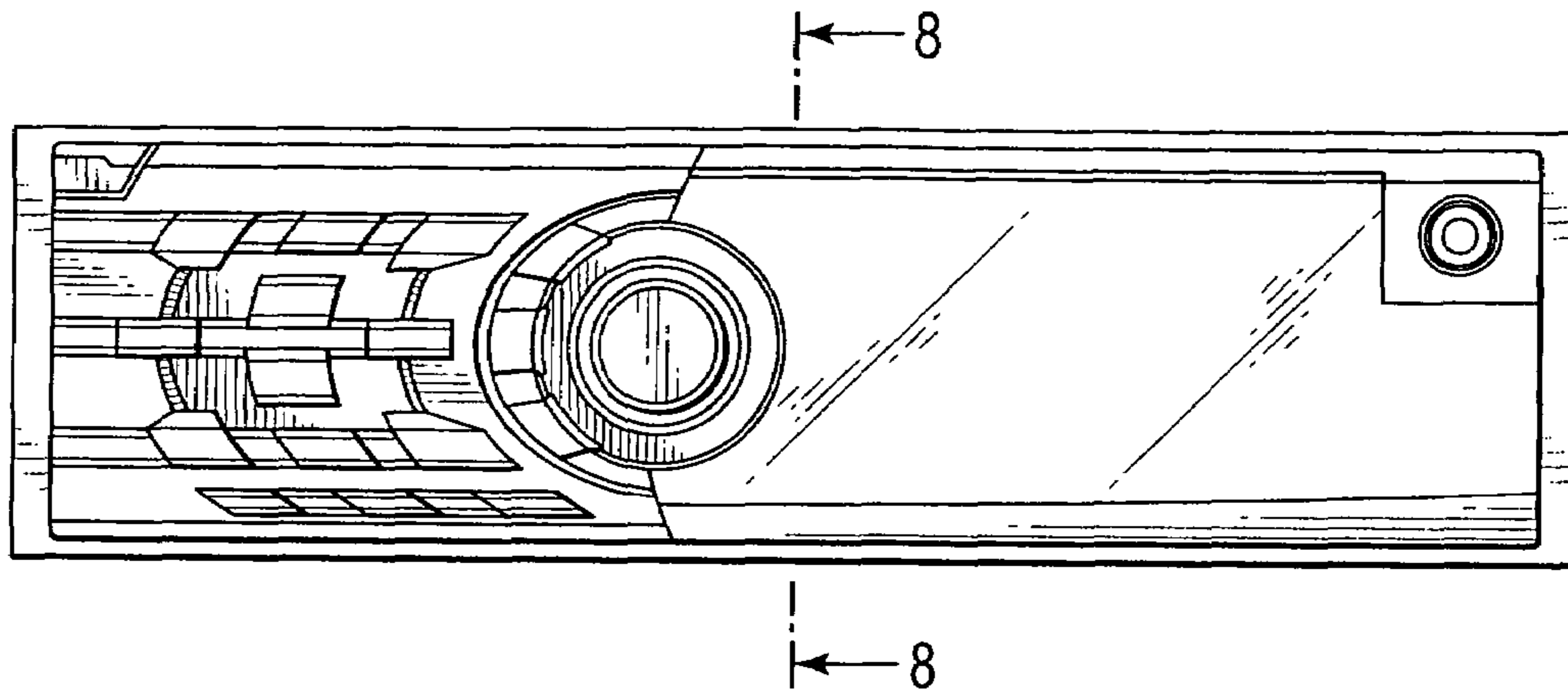

FIG. 2

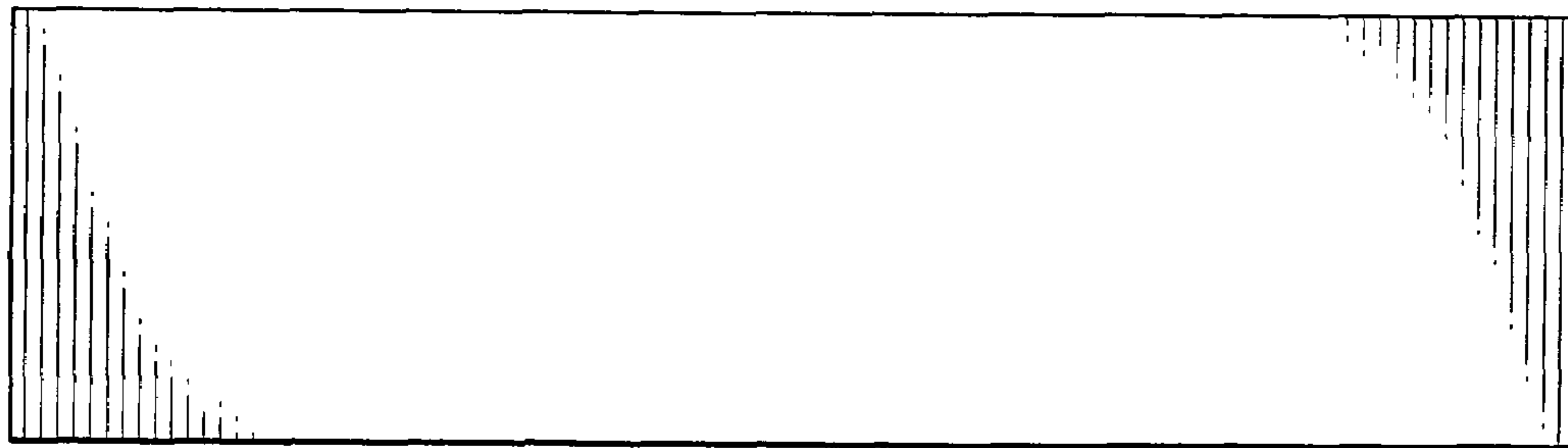

FIG. 3

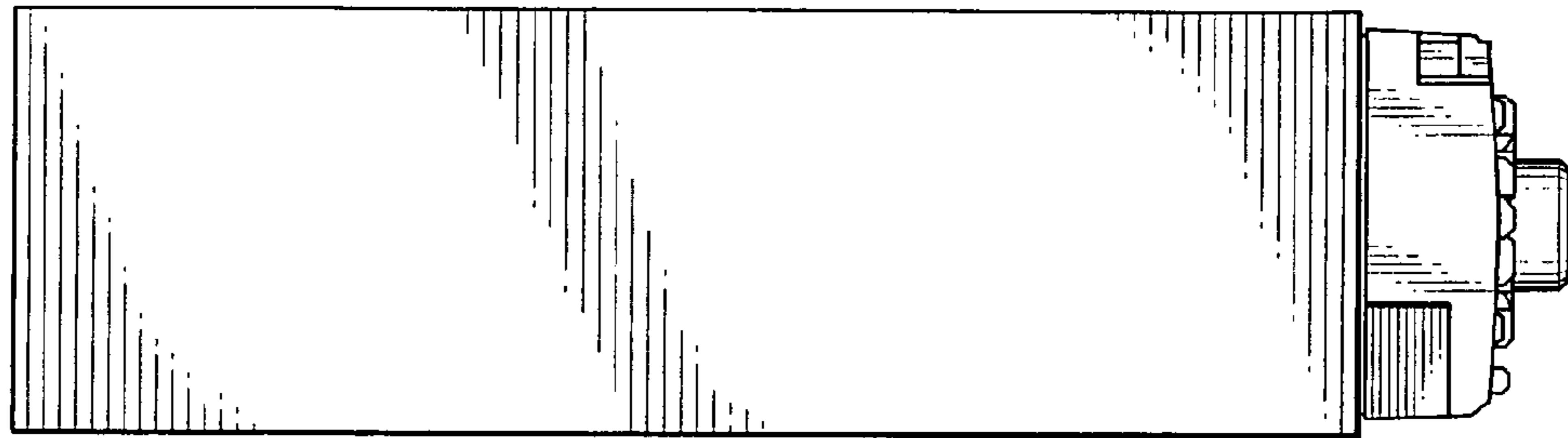

FIG. 4

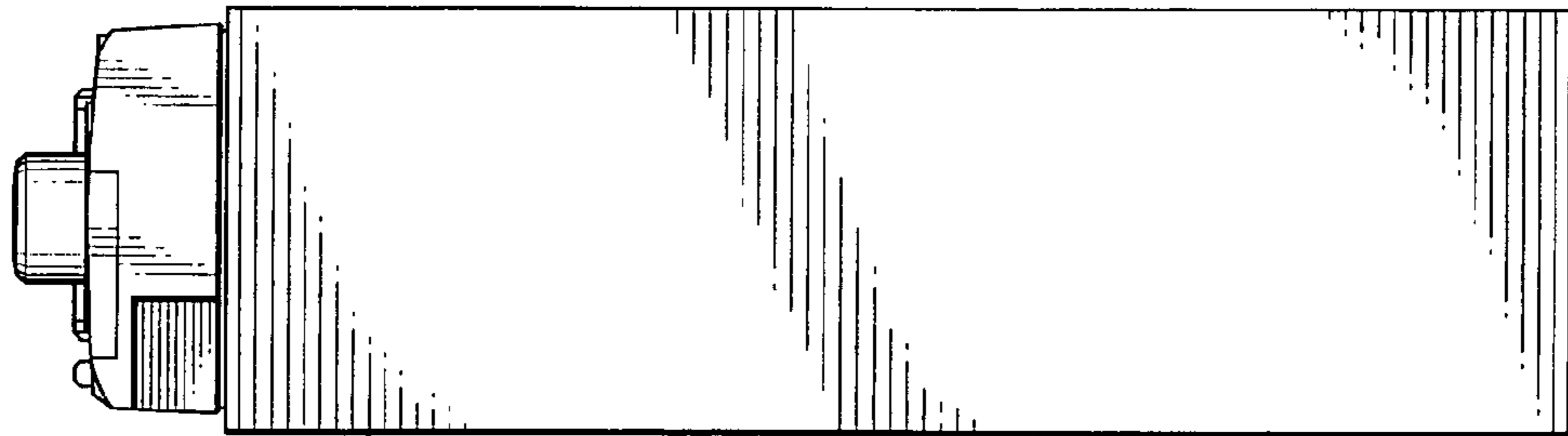

FIG. 5

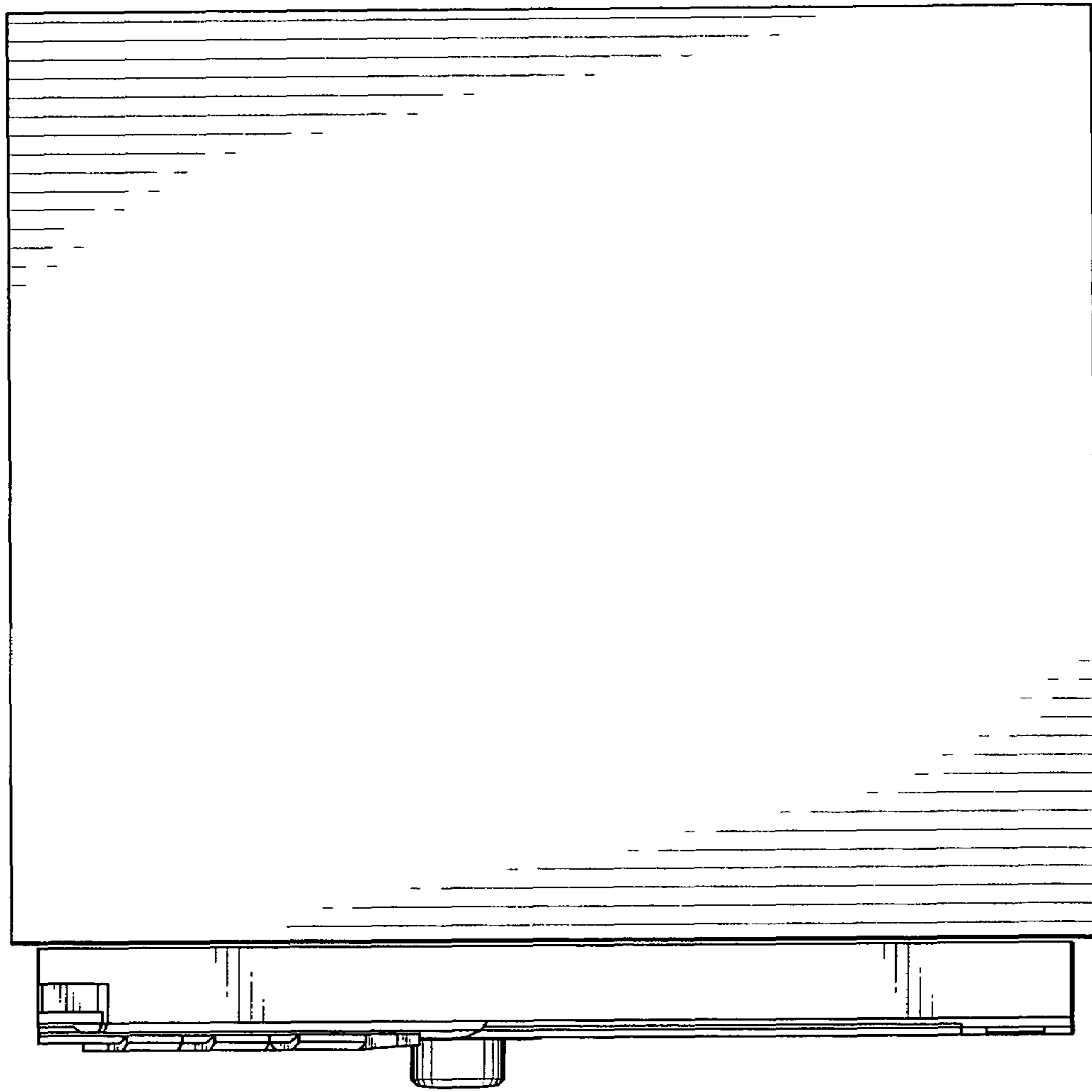

FIG. 6

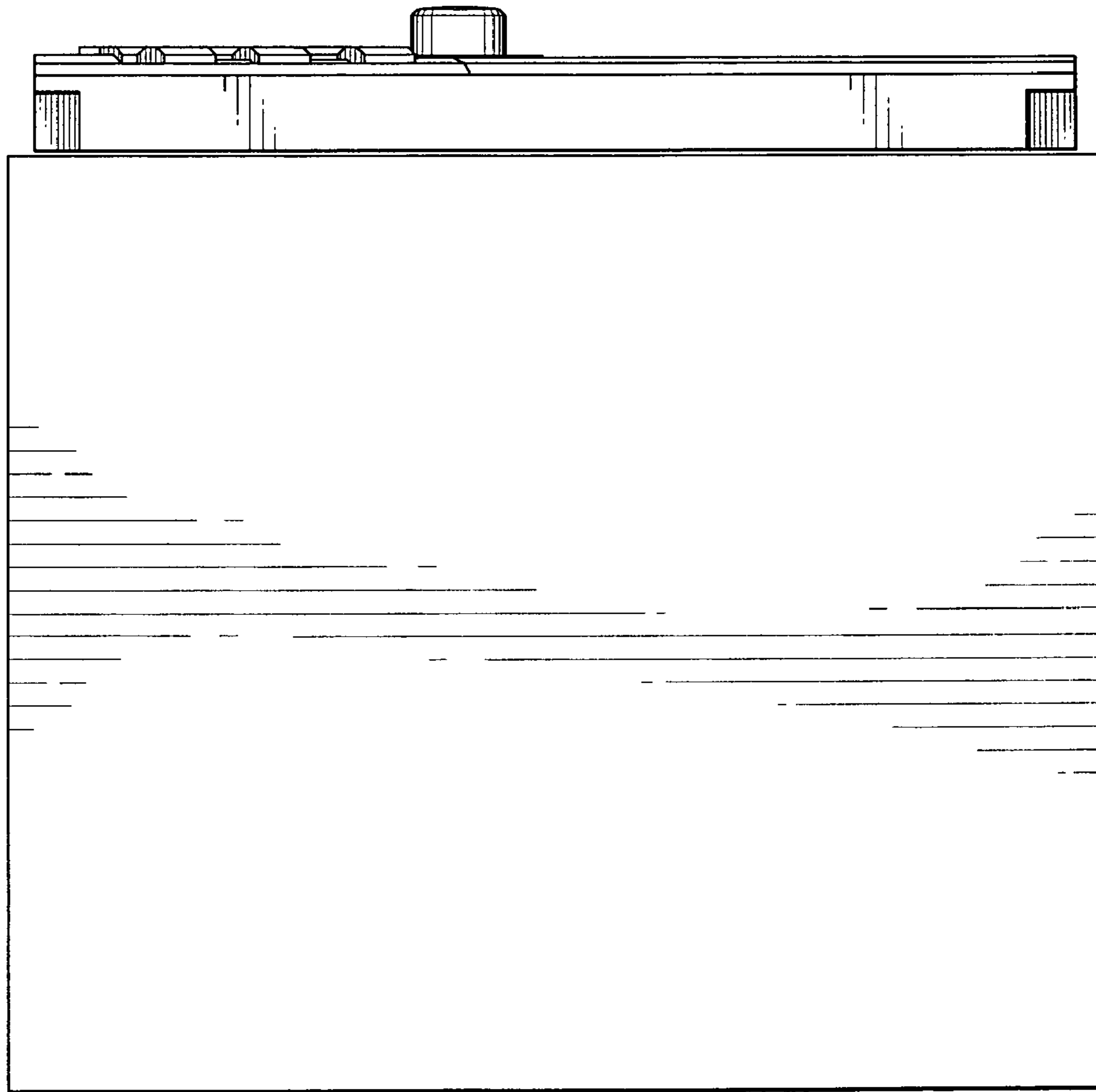

FIG. 7



FIG. 8