



US00D554066S

(12) **United States Design Patent**  
**Kondas**

(10) **Patent No.:** **US D554,066 S**

(45) **Date of Patent:** **\*\* Oct. 30, 2007**

(54) **LOW PROFILE ELECTRICAL TERMINAL**

D516,522 S \* 3/2006 Kondas ..... D13/154  
D516,523 S \* 3/2006 Kondas ..... D13/154

(75) Inventor: **Shawn J. Kondas**, Kendallville, IN  
(US)

\* cited by examiner

(73) Assignee: **Pent Technologies, Inc.**, Kendallville,  
IN (US)

*Primary Examiner*—Daniel Bui  
(74) *Attorney, Agent, or Firm*—Taylor & Aust, P.C.

(\*\*) Term: **14 Years**

(57) **CLAIM**

(21) Appl. No.: **29/245,835**

The ornamental design for a low profile electrical terminal,  
as shown and described.

(22) Filed: **Dec. 29, 2005**

**DESCRIPTION**

(51) **LOC (8) Cl.** ..... **13-03**

(52) **U.S. Cl.** ..... **D13/149; D13/133**

(58) **Field of Classification Search** ..... D13/133,  
D13/149, 154, 184, 199; 439/650, 845, 849-850,  
439/907

See application file for complete search history.

FIG. 1 is a perspective view of a low profile electrical  
terminal showing my new design;  
FIG. 2 is a side elevation view thereof;  
FIG. 3 is an opposite side elevation view thereof;  
FIG. 4 is an end elevation view thereof;  
FIG. 5 is an opposite end elevation view thereof;  
FIG. 6 is a top plan view thereof; and,  
FIG. 7 is a bottom plan view thereof.

(56) **References Cited**

**U.S. PATENT DOCUMENTS**

4,699,445 A \* 10/1987 Porta et al. .... 439/698  
D478,315 S \* 8/2003 Kondas ..... D13/146  
D486,790 S \* 2/2004 Kondas ..... D13/133

**1 Claim, 2 Drawing Sheets**

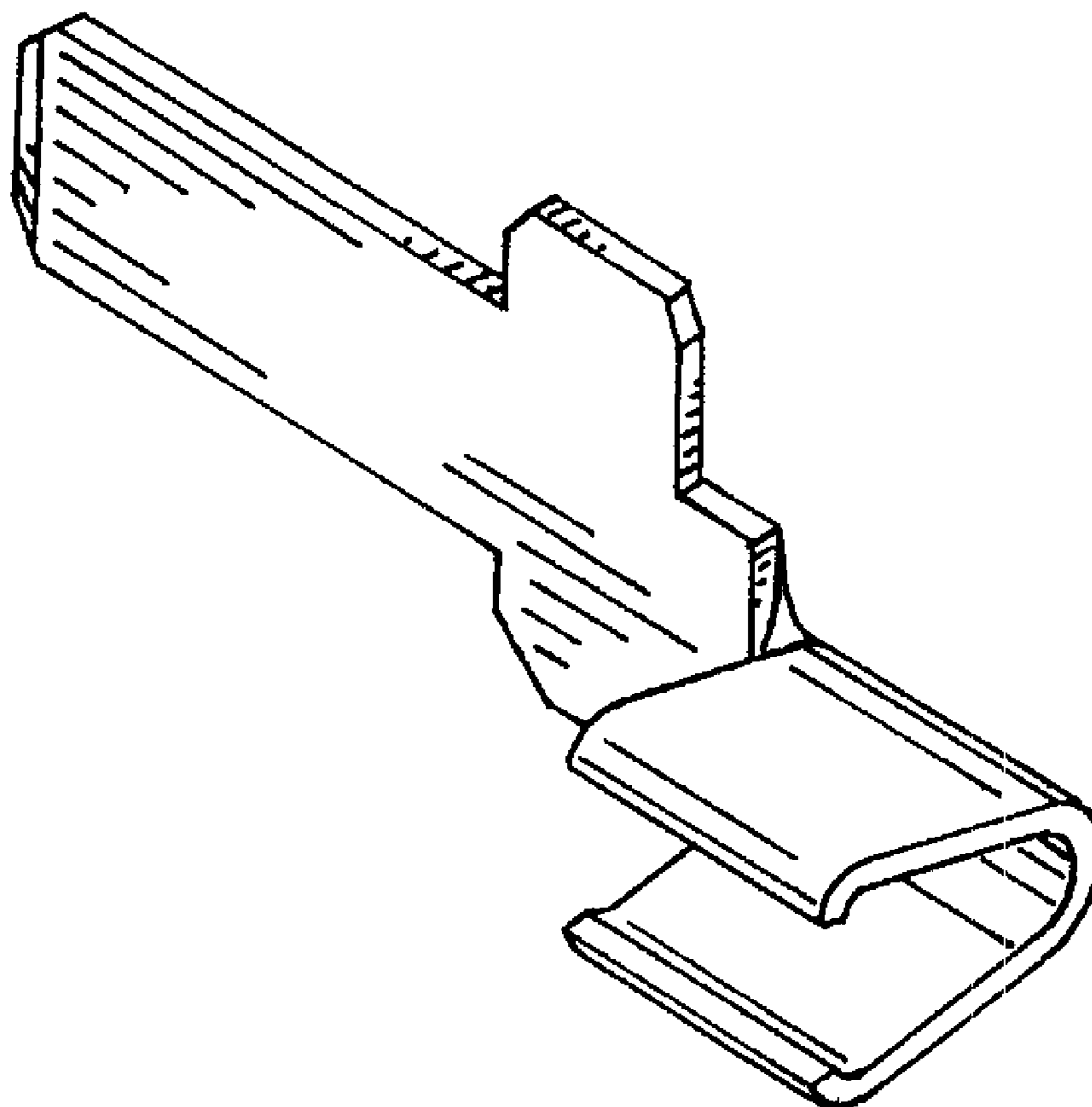

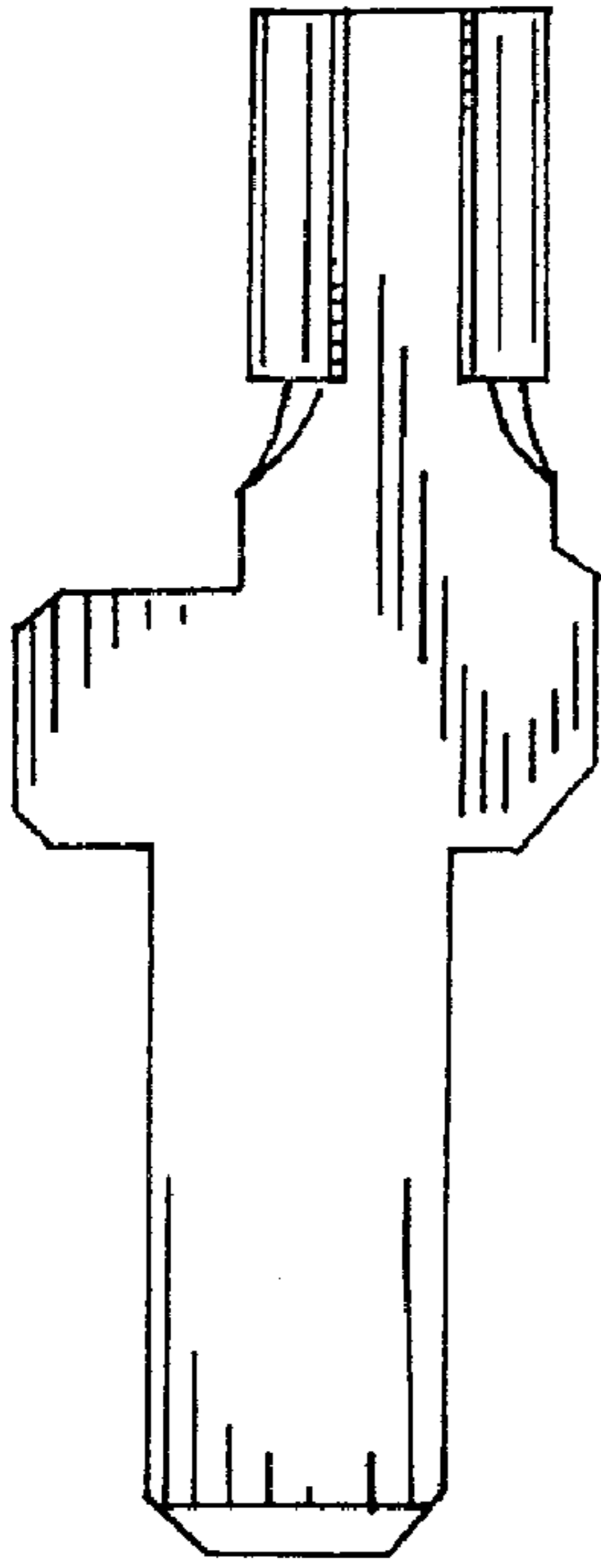

FIG. 2

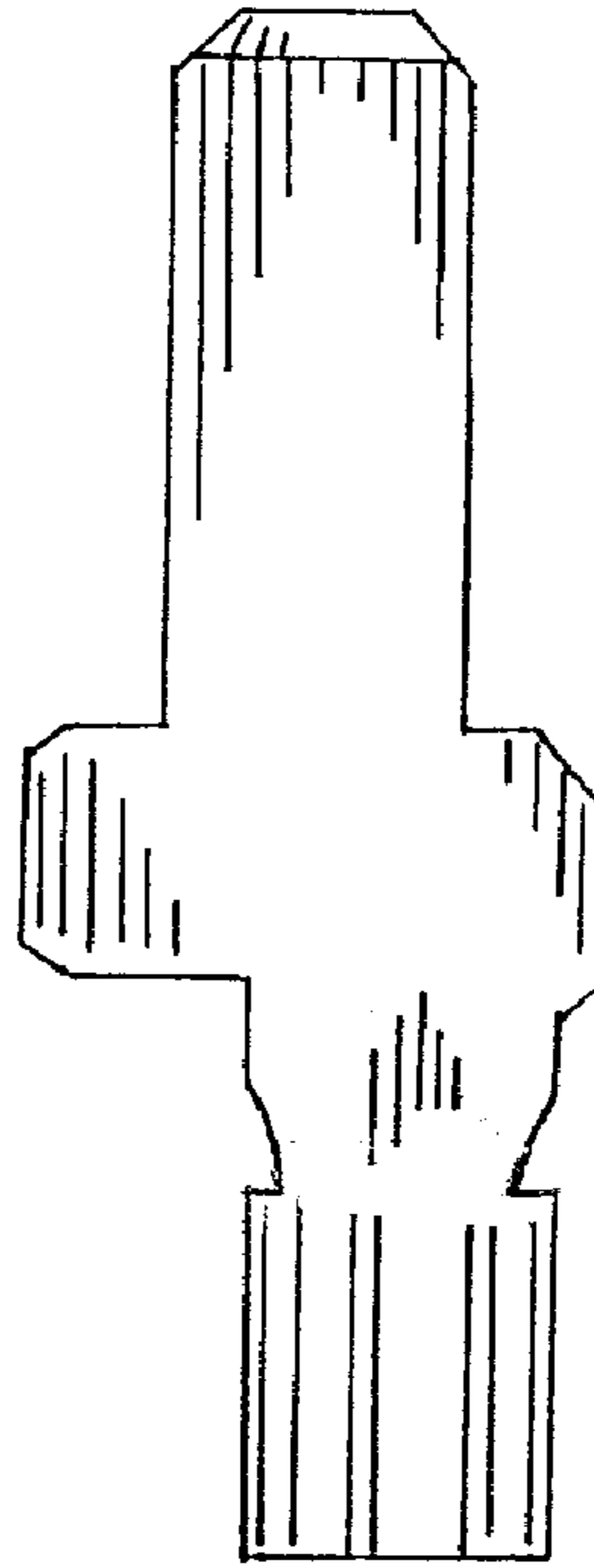

FIG. 3

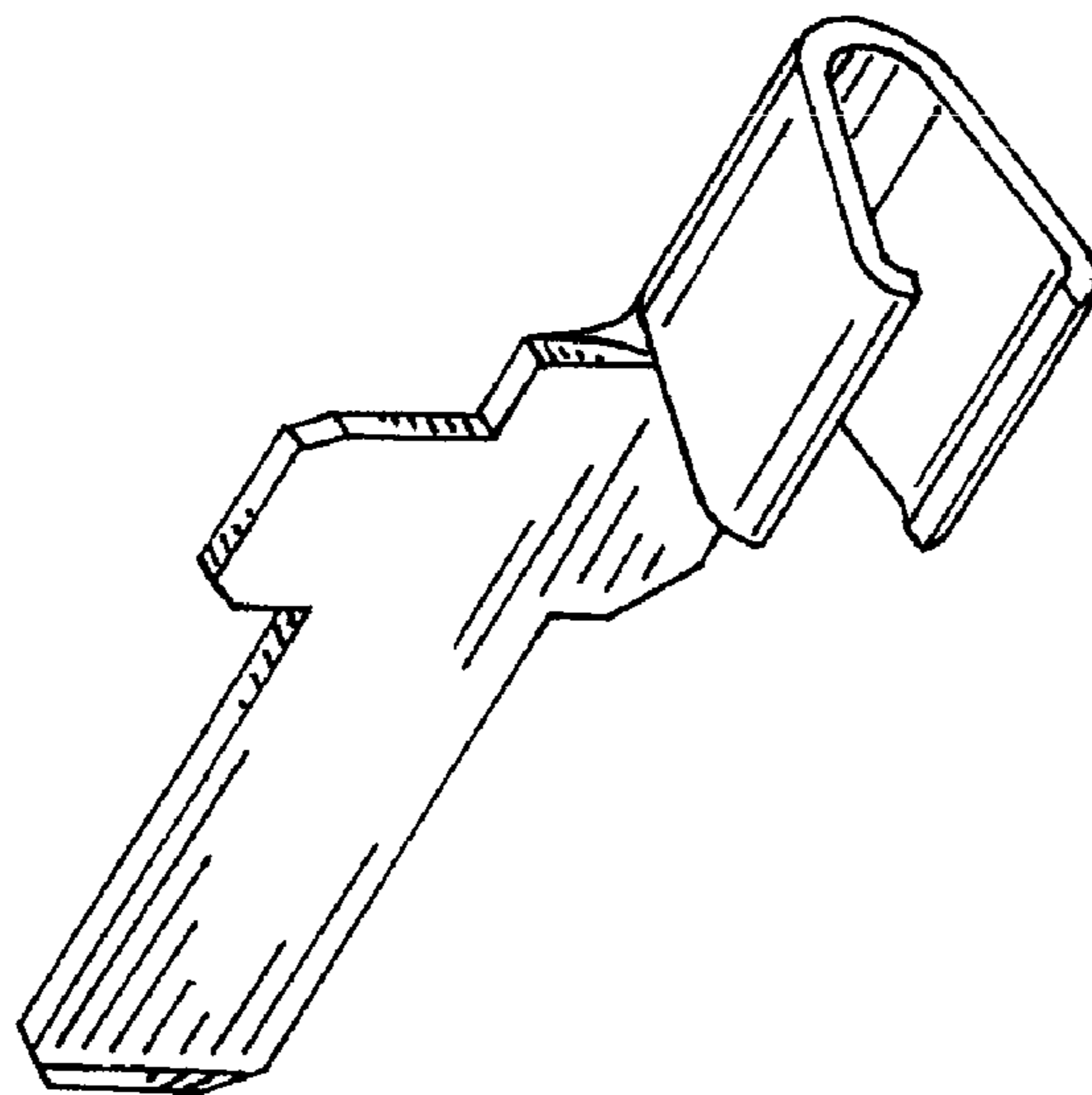

FIG. 1

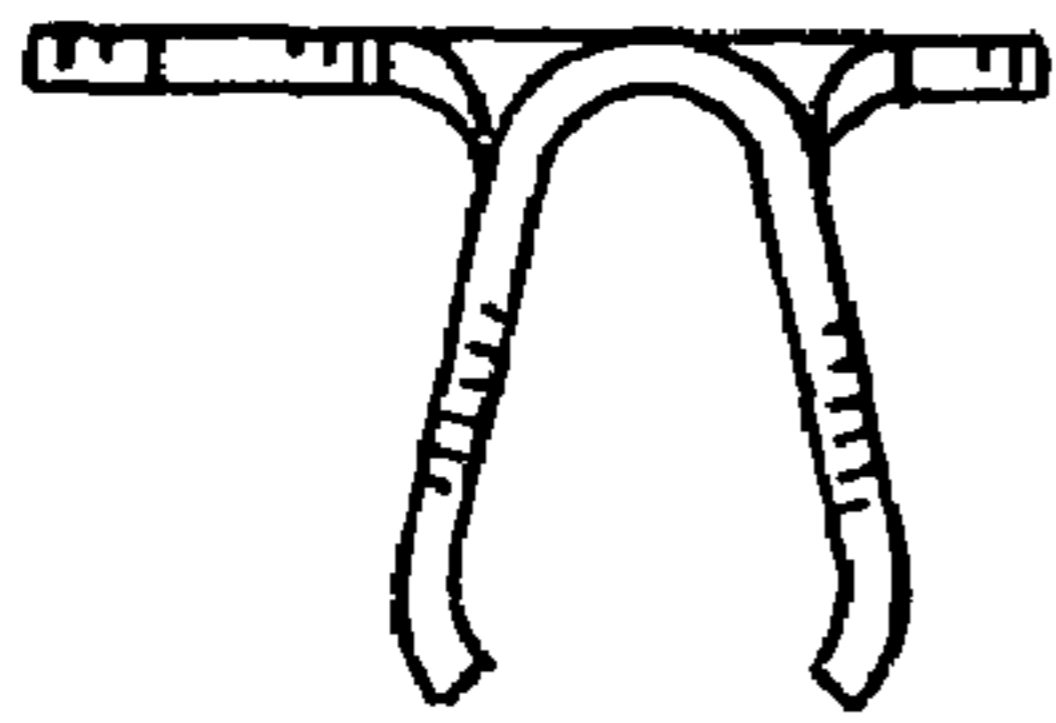

FIG. 4

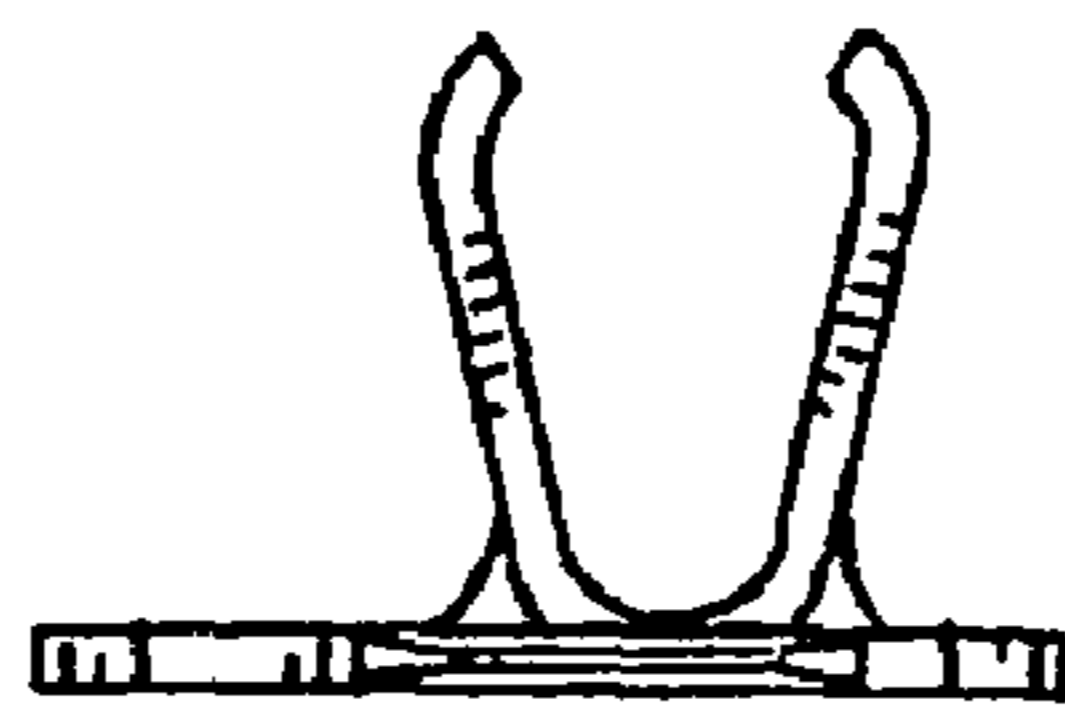

FIG. 5

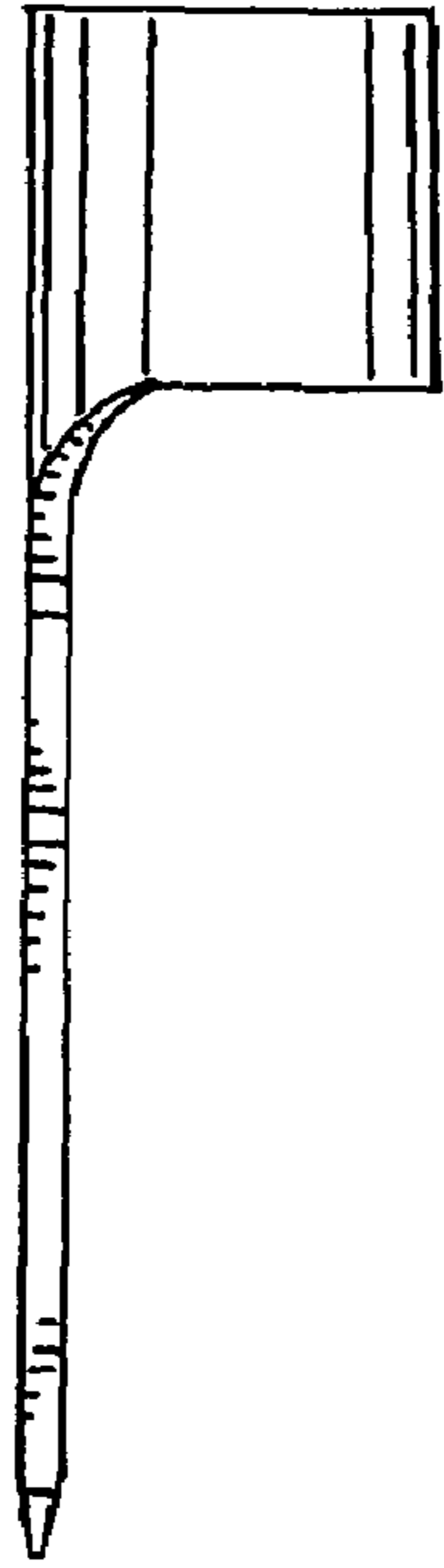

FIG. 6

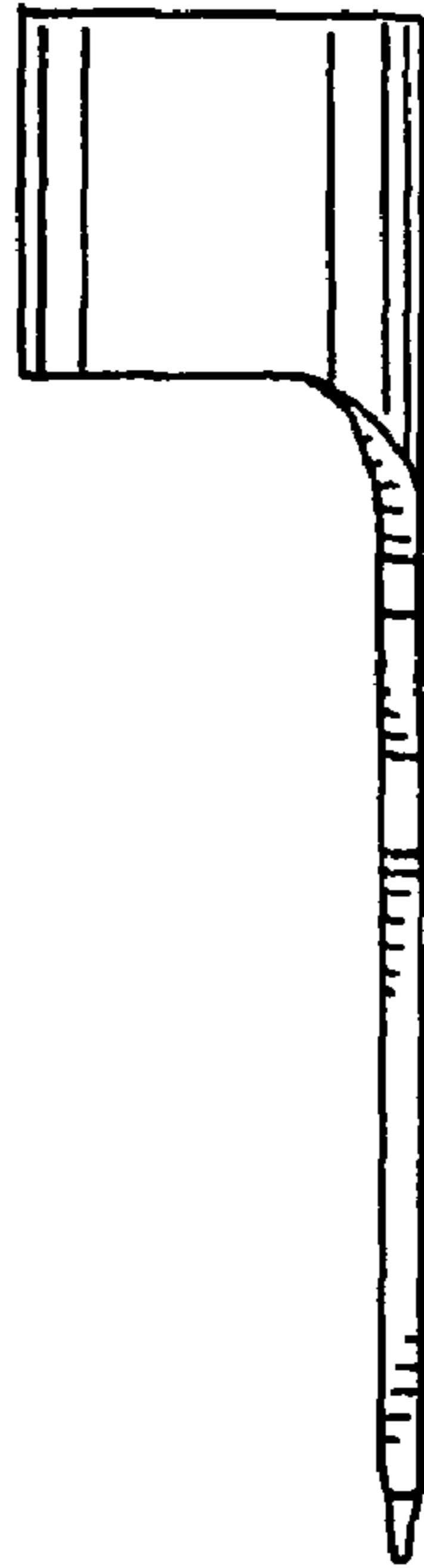

FIG. 7