



US00D554027S

(12) **United States Design Patent**  
**Quinn**

(10) **Patent No.:** **US D554,027 S**

(45) **Date of Patent:** **\*\* Oct. 30, 2007**

(54) **CHILD STROLLER WITH BASEBALL  
HELMET SHAPED CANOPY**

D532,721 S \* 11/2006 Wu et al. .... D12/129  
D538,980 S \* 3/2007 Grepper et al. .... D29/102

(75) Inventor: **Robert A. Quinn**, Tulare, CA (US)

\* cited by examiner

(73) Assignee: **Donacorp**, Tulare, CA (US)

*Primary Examiner*—Ian Simmons

*Assistant Examiner*—Maurice Stevens

(\*\*) Term: **14 Years**

(74) *Attorney, Agent, or Firm*—Blakely Sokoloff Taylor & Zafman LLP

(21) Appl. No.: **29/252,529**

(57) **CLAIM**

(22) Filed: **Jan. 23, 2006**

The ornamental design for a child stroller with baseball helmet shaped canopy, as shown and described.

(51) **LOC (8) Cl.** ..... **12-12**

(52) **U.S. Cl.** ..... **D12/129**

(58) **Field of Classification Search** ..... D12/129–133;  
280/30, 36, 38, 42, 47.38, 641, 643, 650,  
280/658; D29/102–103; D7/606, 632  
See application file for complete search history.

**DESCRIPTION**

FIG. 1 is a perspective view of a child stroller with baseball helmet shaped canopy;

FIG. 2 is a top plan view thereof;

FIG. 3 is a bottom plan view thereof;

FIG. 4 is a left side elevational view thereof;

FIG. 5 is a right side elevational view thereof;

FIG. 6 is a front elevational view thereof; and,

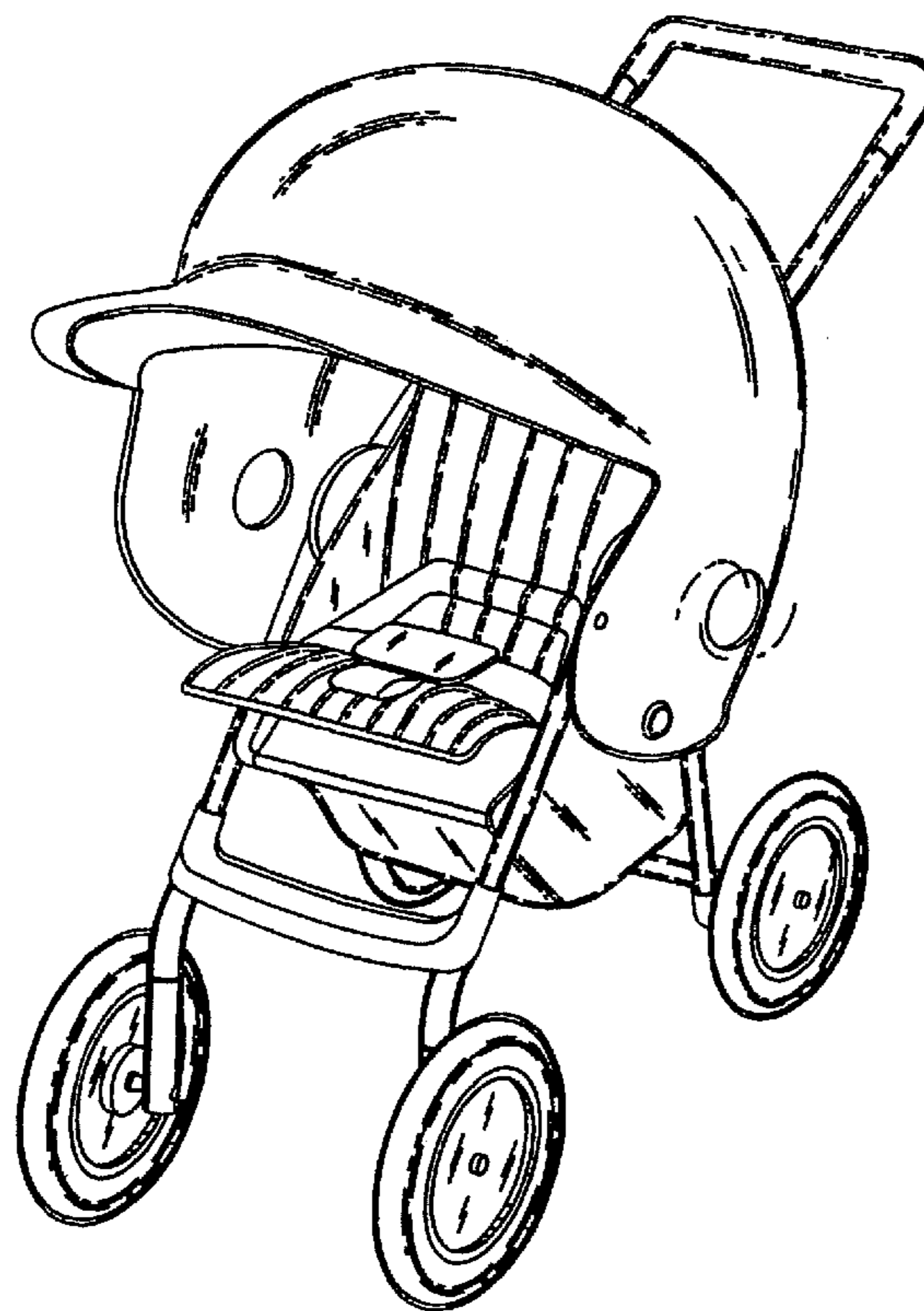
FIG. 7 is a rear elevational view thereof.

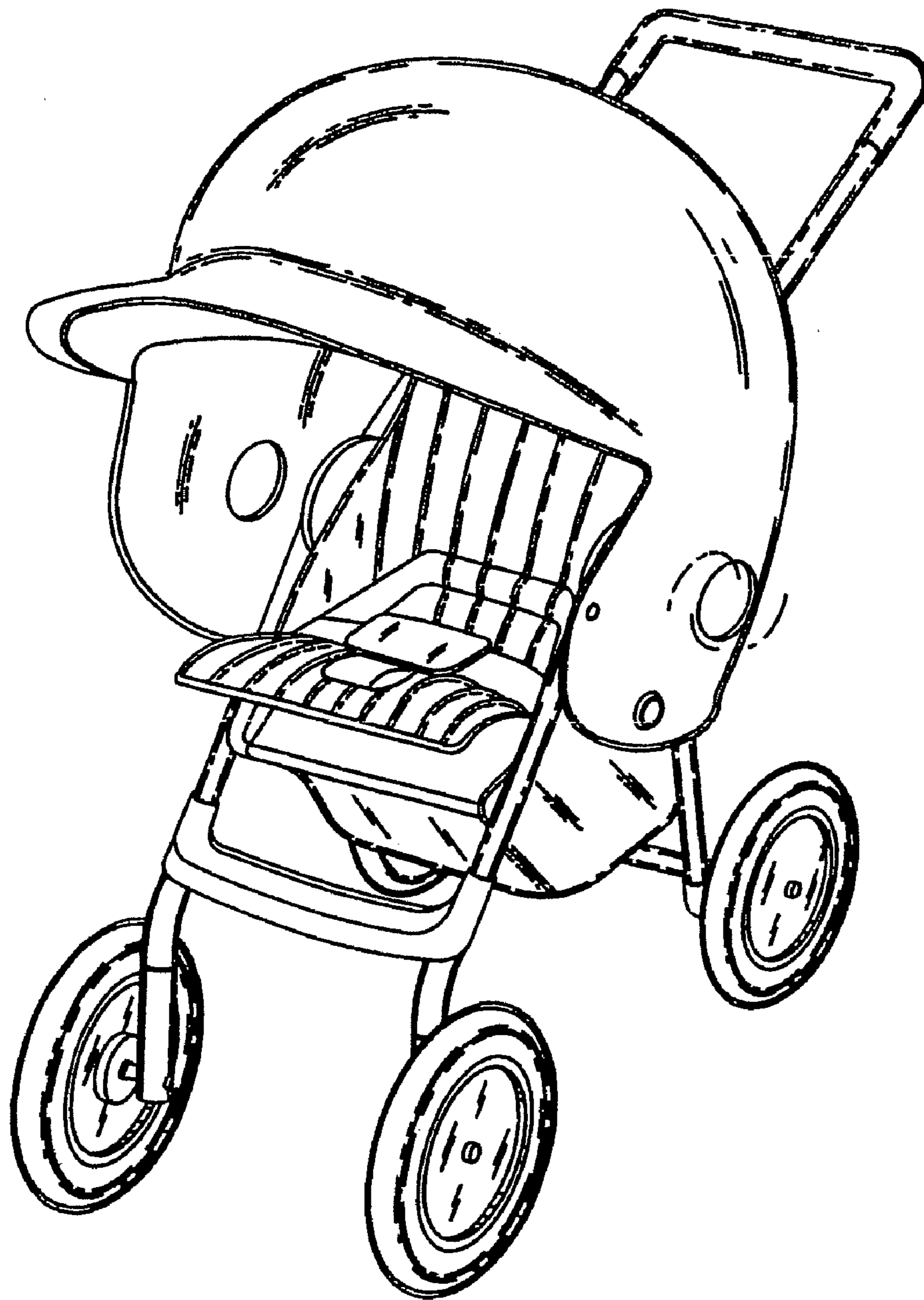
(56) **References Cited**

**U.S. PATENT DOCUMENTS**

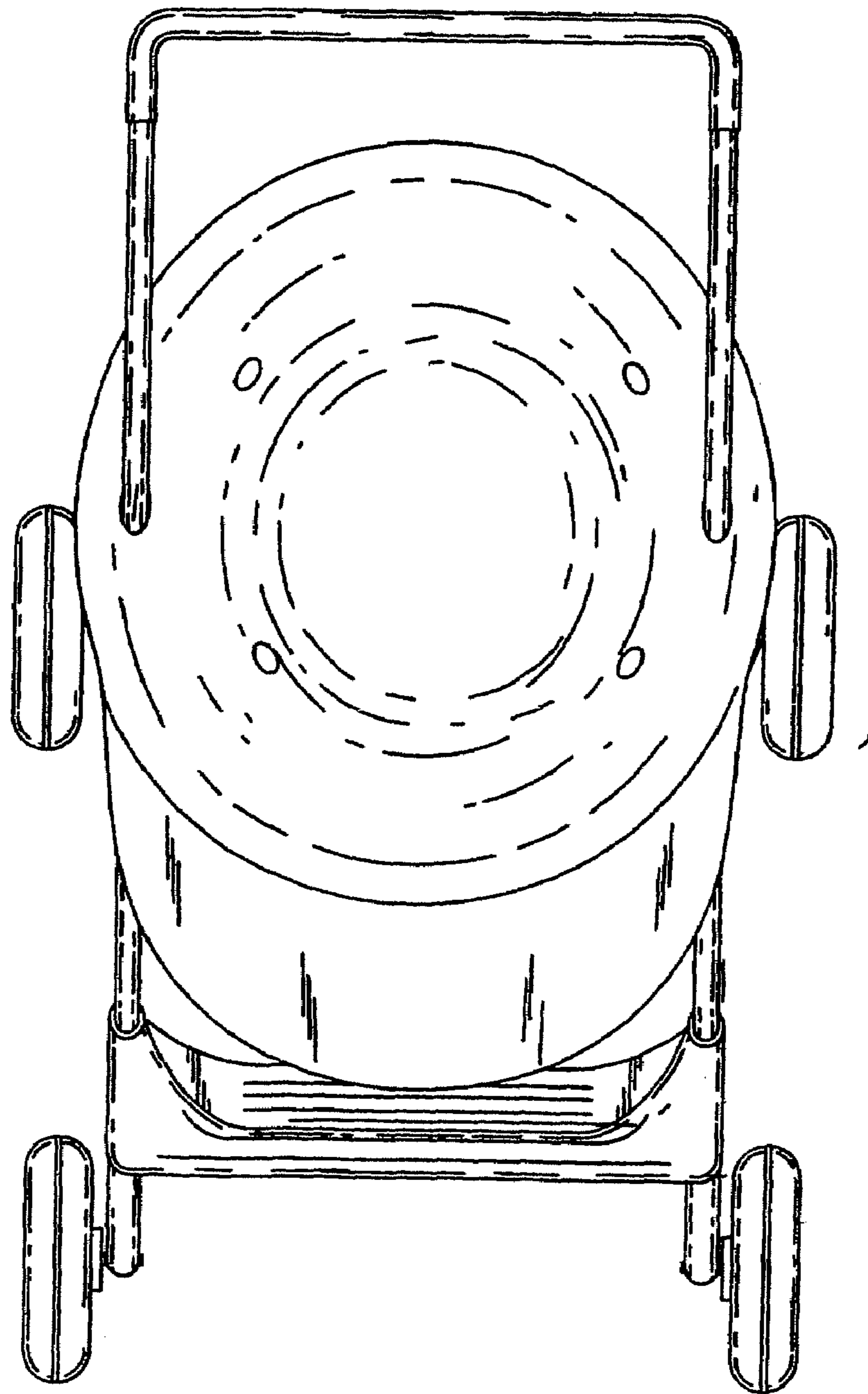
D325,894 S \* 5/1992 Kato et al. .... D12/129  
D345,128 S \* 3/1994 Kassai ..... D12/129  
D475,659 S \* 6/2003 Diaz ..... D12/129  
D479,019 S \* 8/2003 Lishen ..... D29/102  
D510,549 S \* 10/2005 Kassai et al. .... D12/129

**1 Claim, 6 Drawing Sheets**

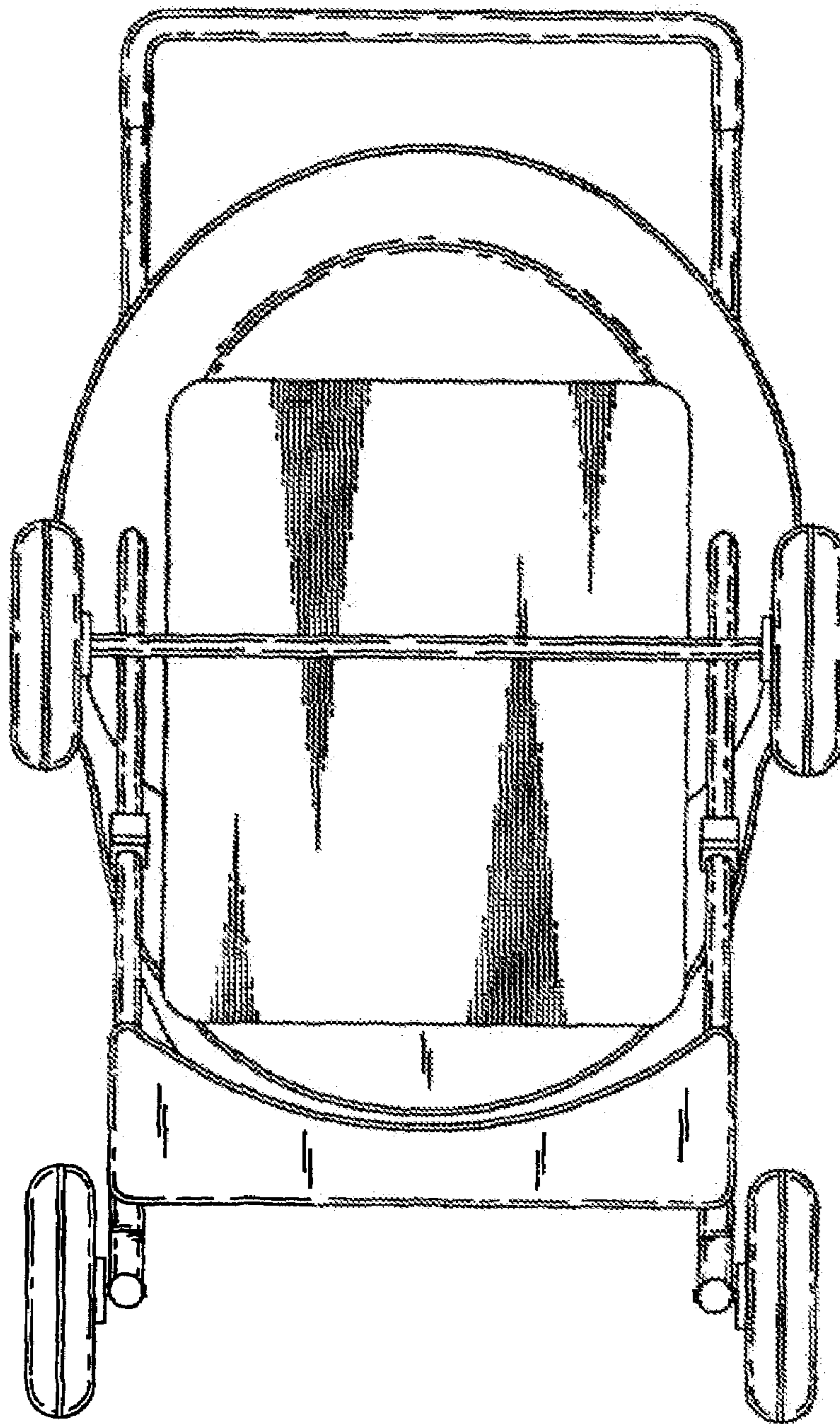




*FIG. 1*

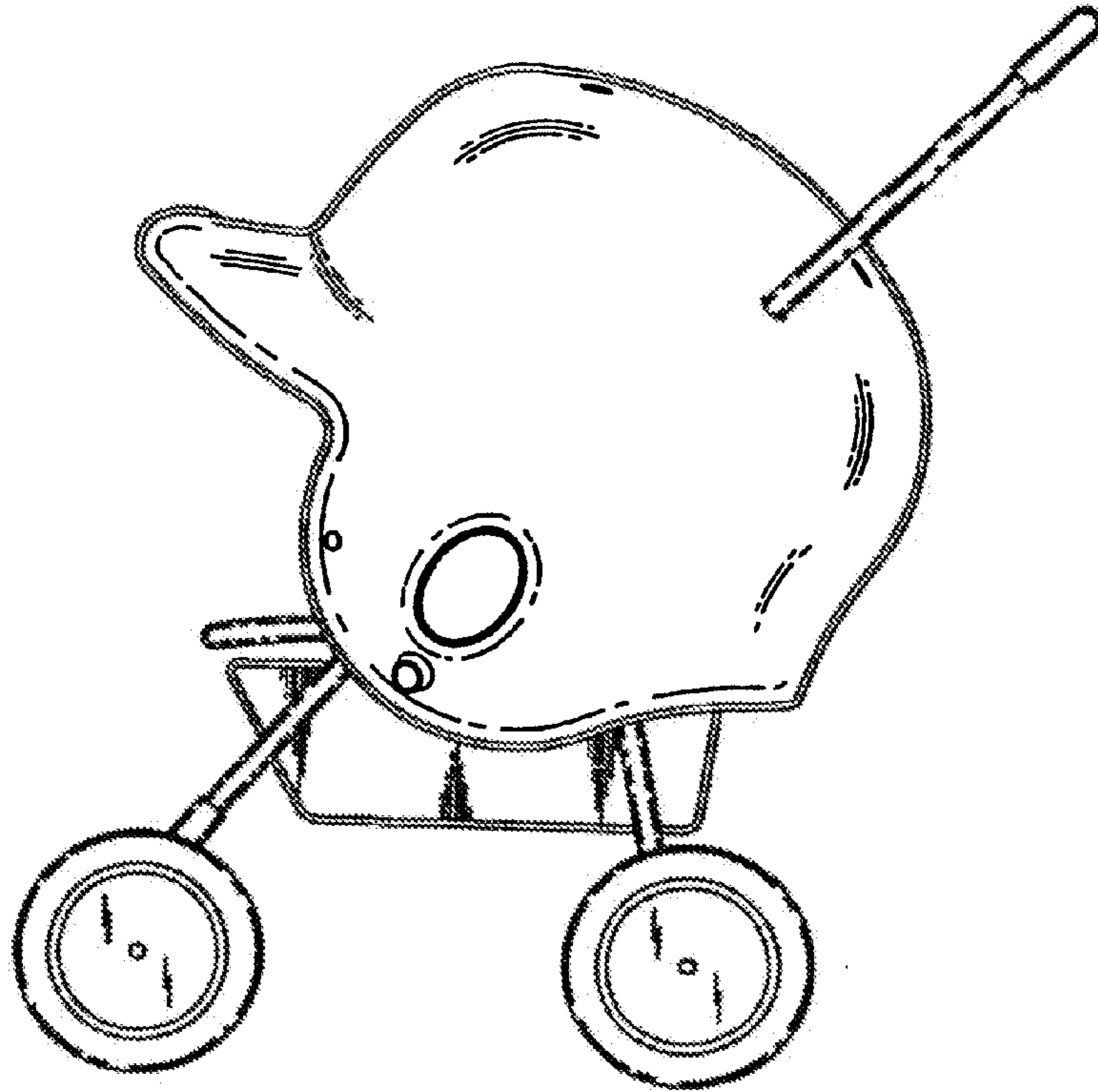


*FIG .2*

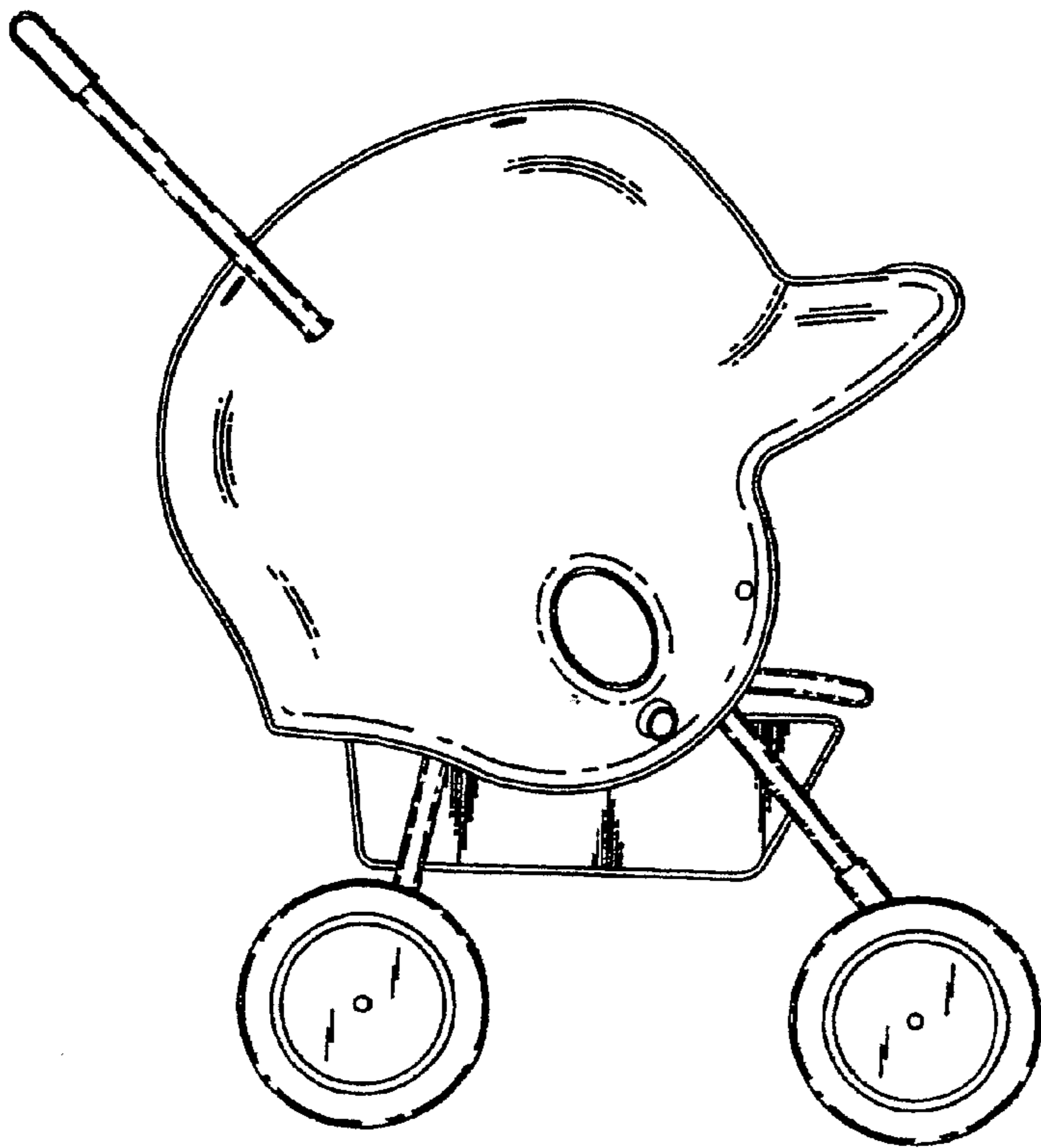


*FIG. 3*

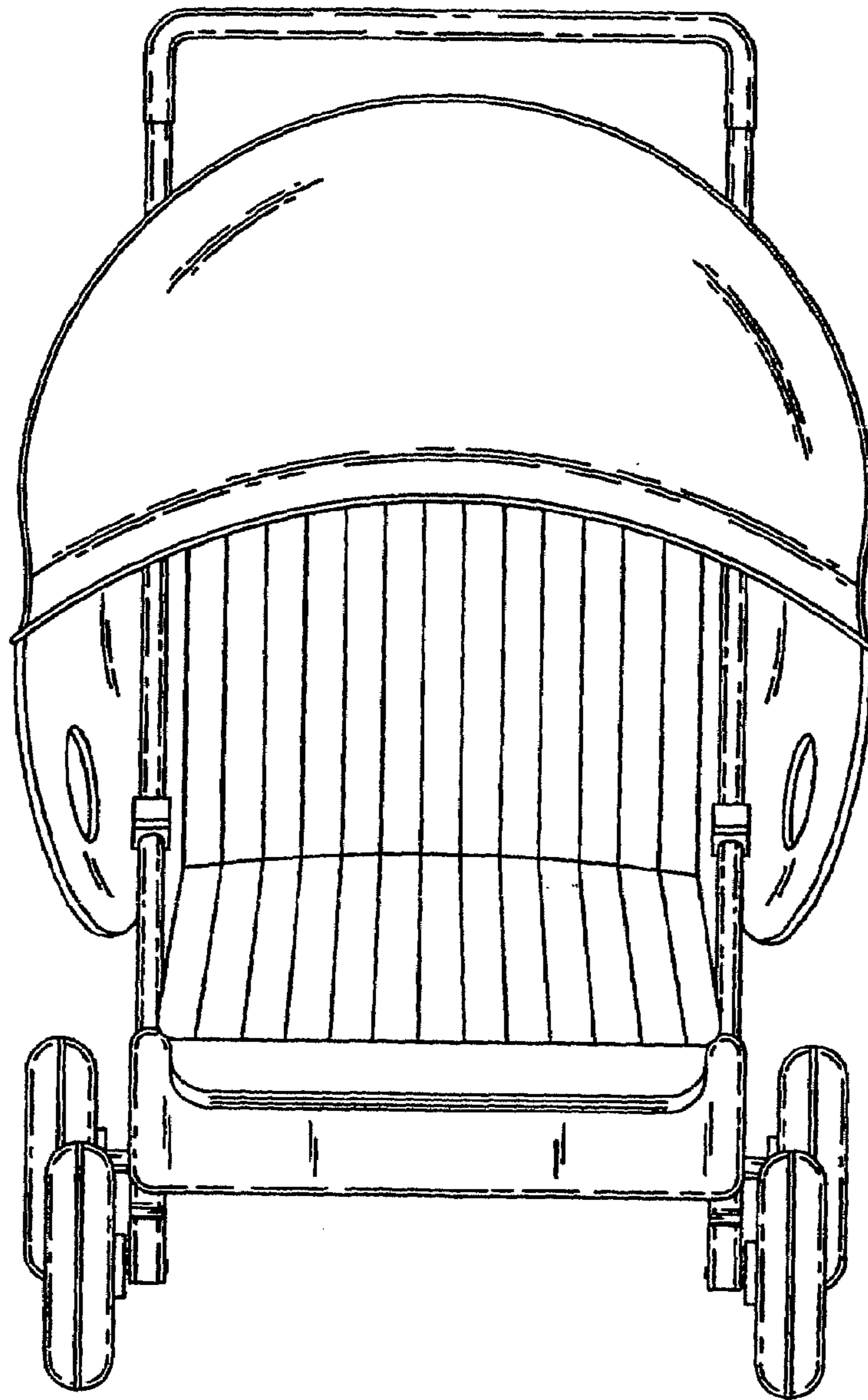




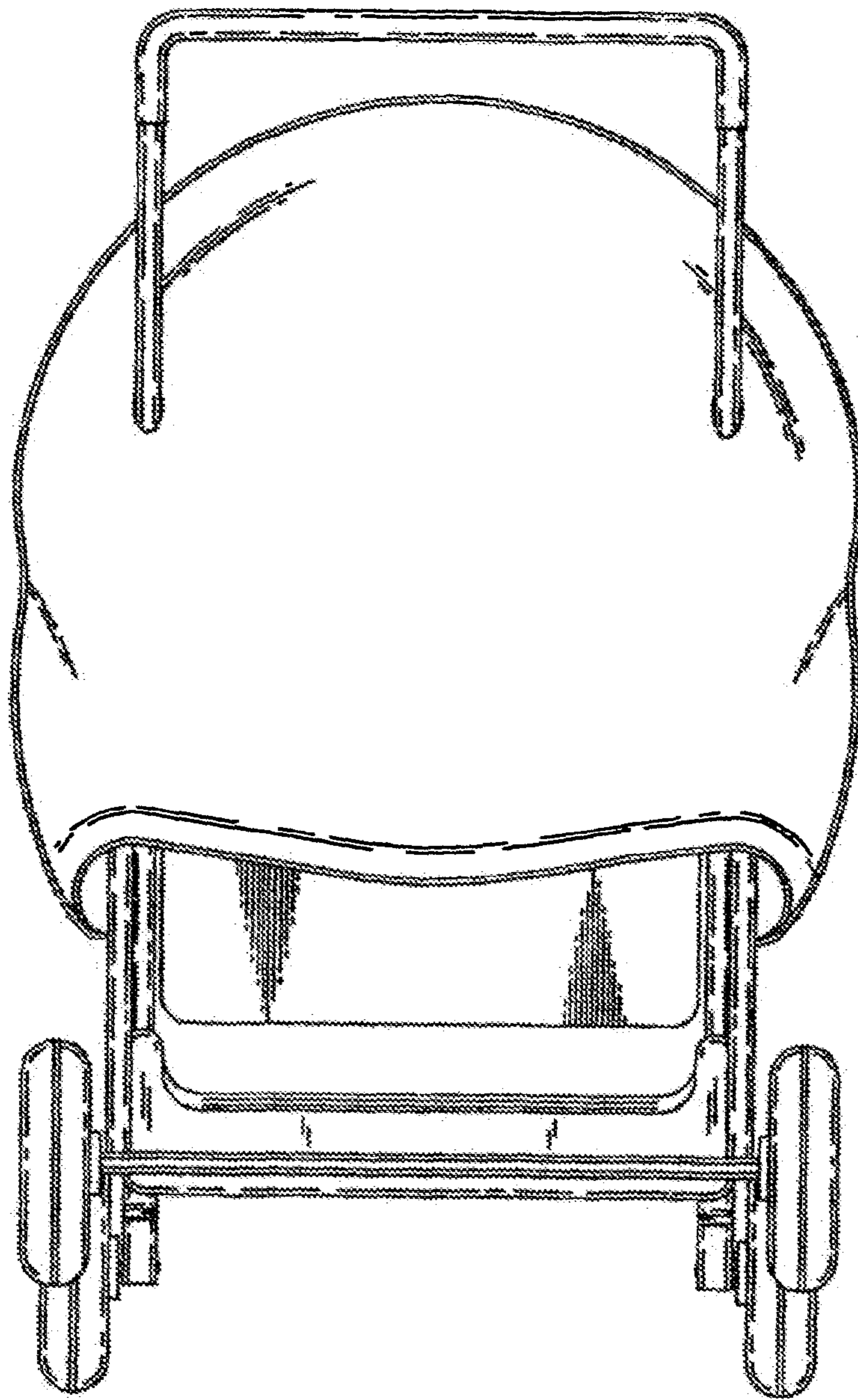
*FIG. 4*



*FIG. 5*



*FIG. 6*



*FIG. 7*