



US00D554005S

(12) **United States Design Patent**
Laucella

(10) **Patent No.:** **US D554,005 S**

(45) **Date of Patent:** **** Oct. 30, 2007**

(54) **WRISTWATCH**

(75) Inventor: **Vincent Laucella**, Le Brassus (CH)

(73) Assignee: **Montres Breguet SA**, L'Abbaye (CH)

(**) Term: **14 Years**

(21) Appl. No.: **29/242,885**

(22) Filed: **Nov. 16, 2005**

(30) **Foreign Application Priority Data**

Jul. 26, 2005 (WO) DM/066 874

(51) **LOC (8) Cl.** **10-02**

(52) **U.S. Cl.** **D10/39**

(58) **Field of Classification Search** D10/30-39,
D10/122-132; 368/276, 277, 281, 282, 285,
368/80, 223, 228, 232, 21, 28

See application file for complete search history.

(56) **References Cited**

U.S. PATENT DOCUMENTS

- 2,857,734 A * 10/1958 Weigenant 368/14
- 3,332,230 A * 7/1967 Pawl 368/27
- 4,653,933 A * 3/1987 Reichel 368/282
- D350,288 S * 9/1994 Giardiello D10/30
- D351,559 S * 10/1994 Helleu D10/39
- D357,193 S * 4/1995 Lefevre D10/39
- D365,772 S * 1/1996 Wunderman D10/32
- D368,664 S * 4/1996 Schick et al. D10/39
- D371,079 S * 6/1996 Mijatovic D10/39

- 5,586,089 A * 12/1996 McGarvey 368/223
- D385,804 S * 11/1997 Toribio D10/30
- D407,029 S * 3/1999 Drucker D10/39
- D447,063 S * 8/2001 Scheufele D10/30
- D467,820 S * 12/2002 Berliat D10/39
- D496,874 S * 10/2004 Nataf D10/126

OTHER PUBLICATIONS

Watches International VI, The Original Annual of the World's Finest Wristwatches, copyright 2005 by Tourbillon International LLC., p. 134, Breguet watches.*

* cited by examiner

Primary Examiner—Lucy Lieberman

(74) *Attorney, Agent, or Firm*—Collen IP; Donald J. Ranft

(57) **CLAIM**

The ornamental design for a wristwatch, as shown and described.

DESCRIPTION

FIG. 1 is a front view of my new and ornamental design for a wristwatch;

FIG. 2 is a right side elevation thereof;

FIG. 3 is a left side elevation thereof;

FIG. 4 is a top view thereof;

FIG. 5 is a bottom view thereof; and,

FIG. 6 is a perspective view thereof.

1 Claim, 2 Drawing Sheets

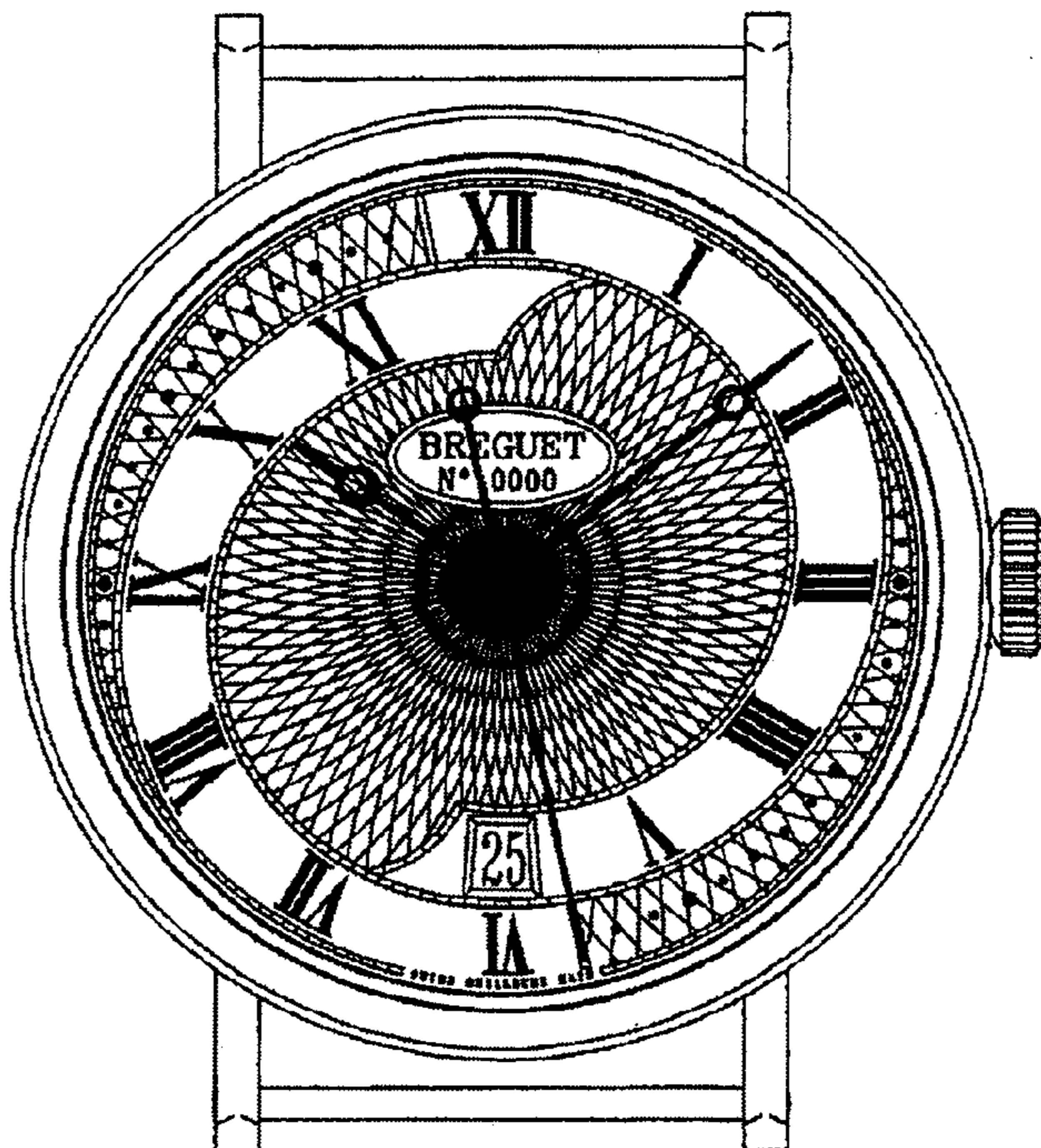

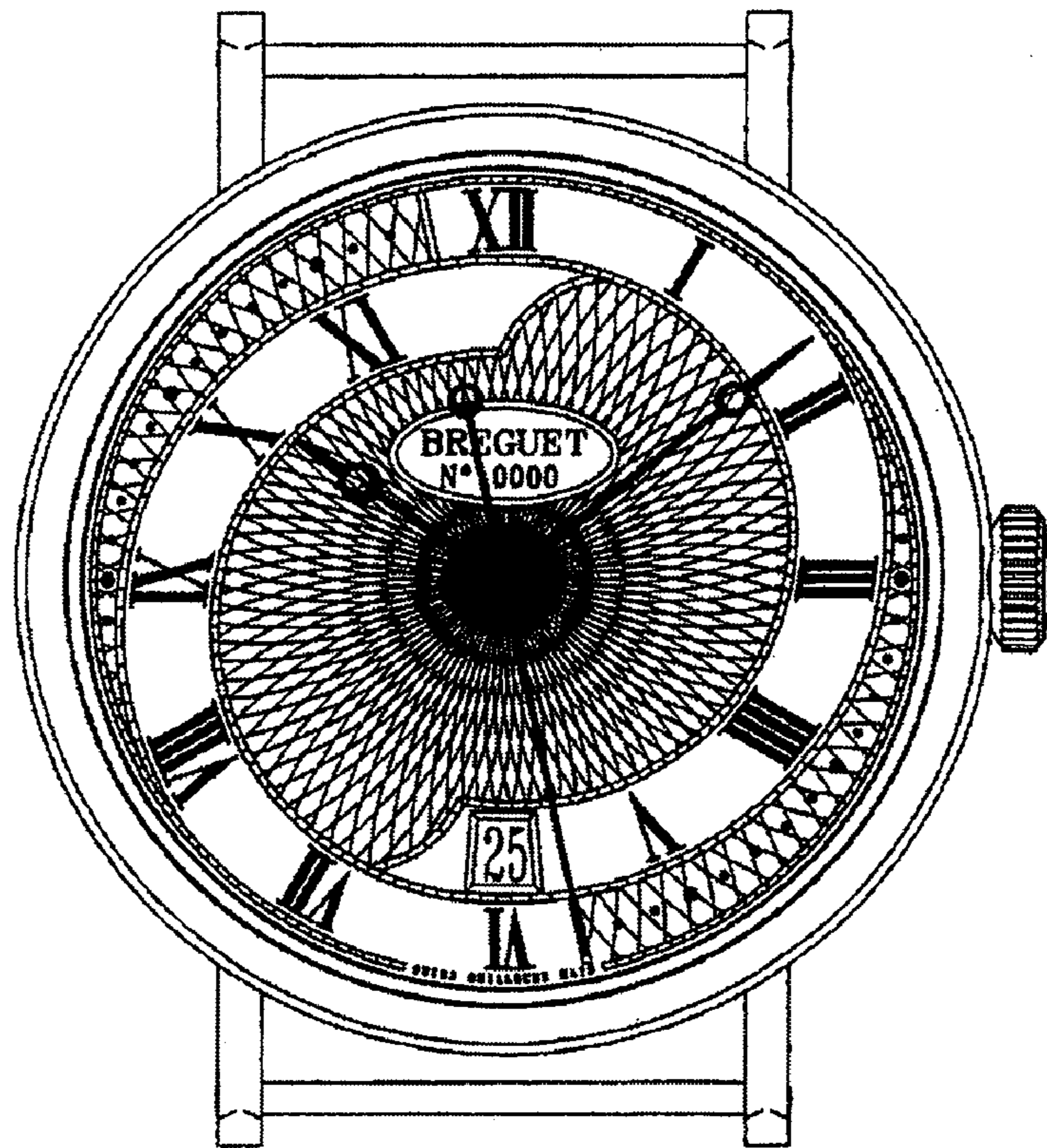

Fig. 1

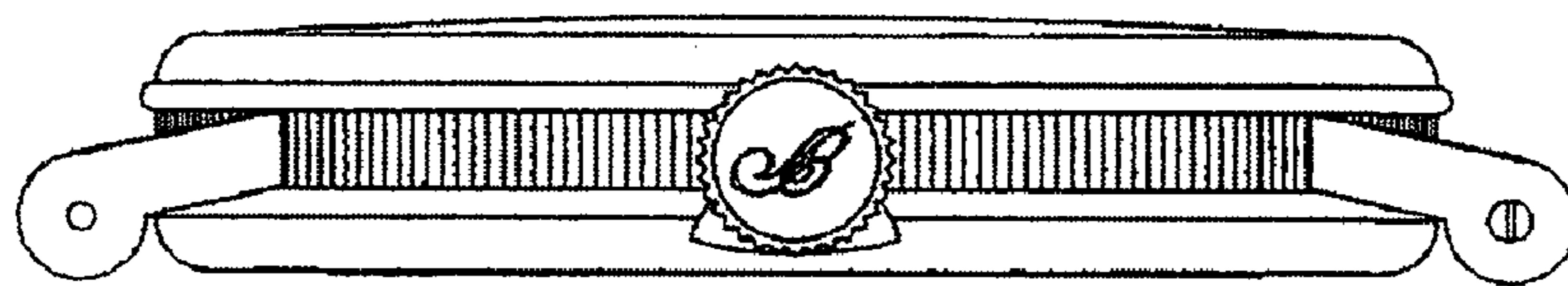

Fig. 2

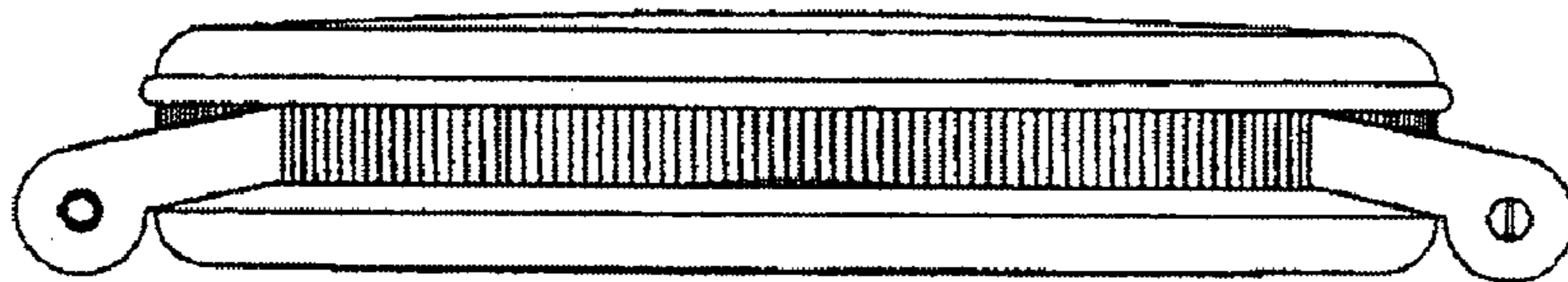

Fig. 3

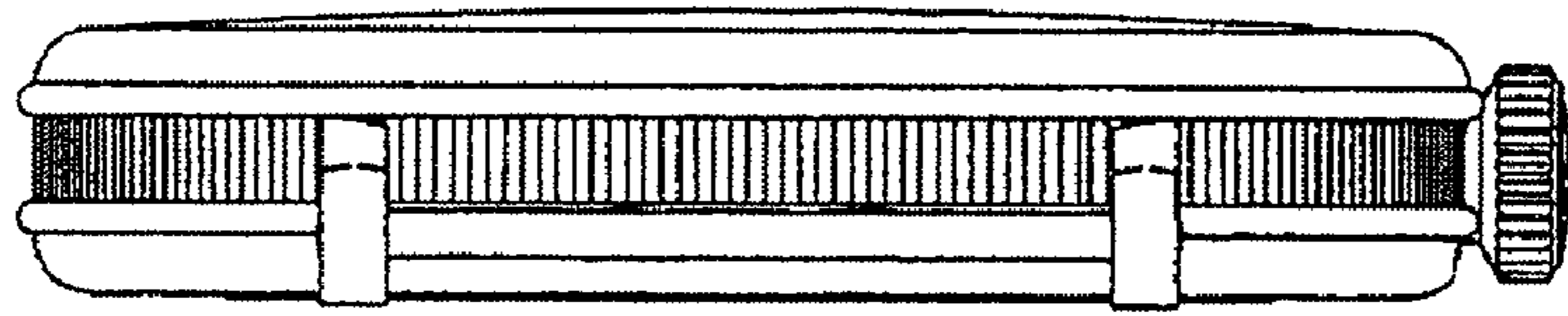

Fig. 4

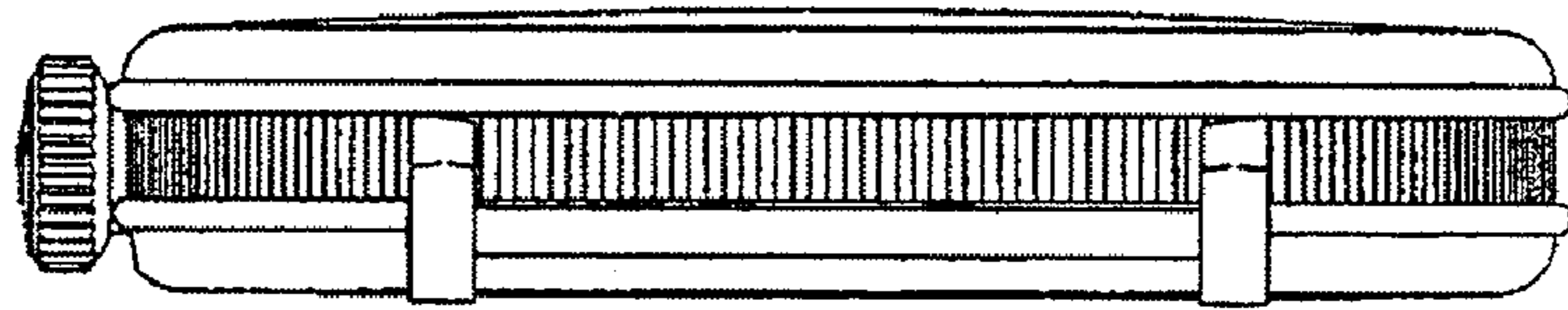

Fig. 5

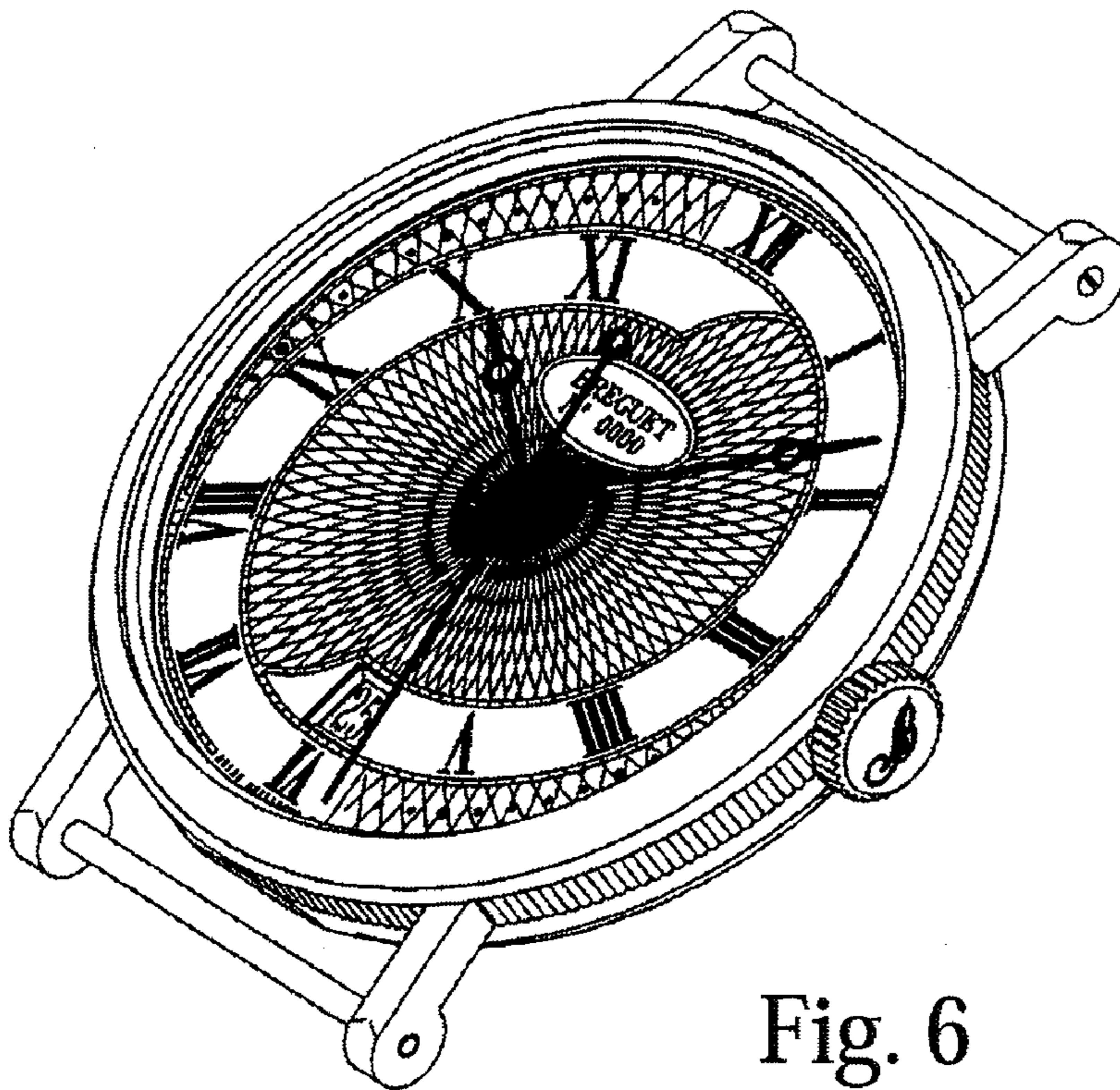

Fig. 6