



US00D553909S

(12) **United States Design Patent** (10) **Patent No.:** **US D553,909 S**  
**Bodum** (45) **Date of Patent:** **\*\* Oct. 30, 2007**

(54) **DOUBLE WALLED GLASS**  
(75) Inventor: **Jørgen Bodum**, St. Niklausen (CH)  
(73) Assignee: **Pi-Design AG**, Triengen (CH)  
(\*\*) Term: **14 Years**  
(21) Appl. No.: **29/250,633**  
(22) Filed: **Nov. 24, 2006**

(30) **Foreign Application Priority Data**  
Jun. 22, 2006 (DK) ..... DA 2006 00164  
(51) **LOC (8) Cl.** ..... **07-01**  
(52) **U.S. Cl.** ..... **D7/523; D7/509; D7/500**  
(58) **Field of Classification Search** ..... D7/396.2,  
D7/500, 509, 510, 523, 524, 526-528, 530-532,  
D7/540, 565, 584, 900; D9/500, 502, 516,  
D9/519, 549, 555, 776, 778; D34/1; 215/10,  
215/387, DIG. 7; 220/495.04, 560, 592.16,  
220/592.17, 703; 226/406; 229/400; 383/110  
See application file for complete search history.

(56) **References Cited**  
**U.S. PATENT DOCUMENTS**  
D4,225 S \* 7/1870 Atterbuy et al. .... D9/500  
723,796 A \* 3/1903 Williams ..... 220/592.17  
2,051,446 A \* 8/1936 Ice ..... 215/12.1  
D108,788 S \* 3/1938 Kostellow ..... D7/523  
3,269,144 A \* 8/1966 Poris ..... 62/457.3  
D289,484 S \* 4/1987 Forquer et al. .... D7/532  
D438,430 S \* 3/2001 Gabrhel ..... D7/523  
D471,404 S \* 3/2003 Gady ..... D7/523  
D484,365 S \* 12/2003 Wyche ..... D7/523  
D488,673 S \* 4/2004 Farce ..... D7/523  
D519,785 S \* 5/2006 Bodum ..... D7/523  
D523,693 S \* 6/2006 Bodum ..... D7/523

\* cited by examiner

*Primary Examiner*—Philip S. Hyder  
*Assistant Examiner*—Cynthia Underwood  
(74) *Attorney, Agent, or Firm*—Cowan, Liebowitz & Latman, PC

(57) **CLAIM**

The ornamental design for a double walled glass, as shown and described.

**DESCRIPTION**

FIG. 1 is a perspective view of a first embodiment of the double walled glass showing my design thereof;  
FIG. 2 is a front view thereof;  
FIG. 3 is a back view thereof;  
FIG. 4 is a right side view thereof;  
FIG. 5 is a left side view thereof;  
FIG. 6 is a top view thereof;  
FIG. 7 is a bottom view thereof;  
FIG. 8 is a cross-sectional view thereof taken through section 8—8 of FIG. 6;  
FIG. 9 is a perspective view of a second embodiment of the double walled glass showing my design thereof;  
FIG. 10 is a front view thereof;  
FIG. 11 is a back view thereof;  
FIG. 12 is a right side view thereof;  
FIG. 13 is a left side view thereof;  
FIG. 14 is a top view thereof;  
FIG. 15 is a bottom view thereof; and,  
FIG. 16 is a cross-sectional view thereof taken through section 16—16 of FIG. 14.

**1 Claim, 16 Drawing Sheets**

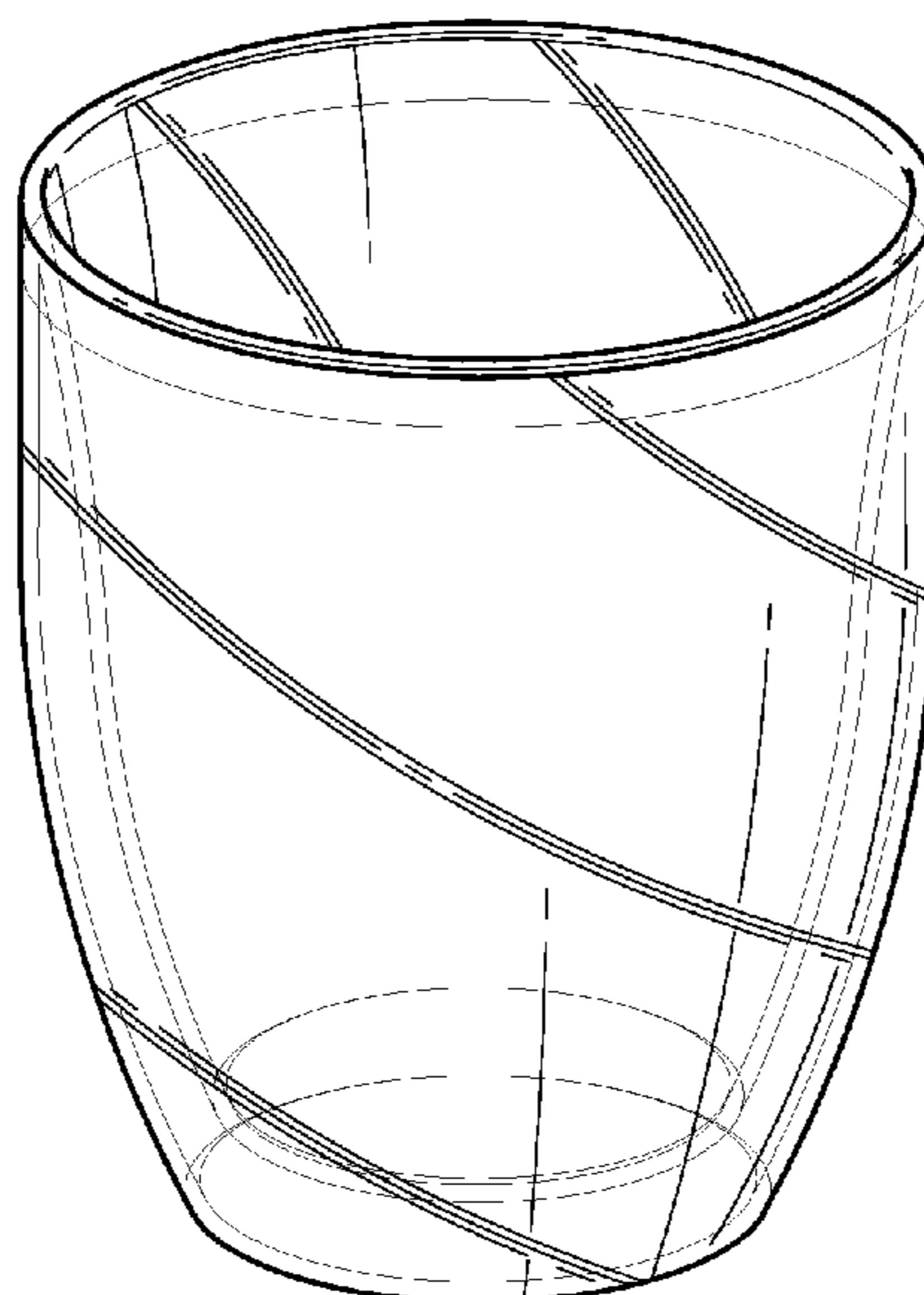

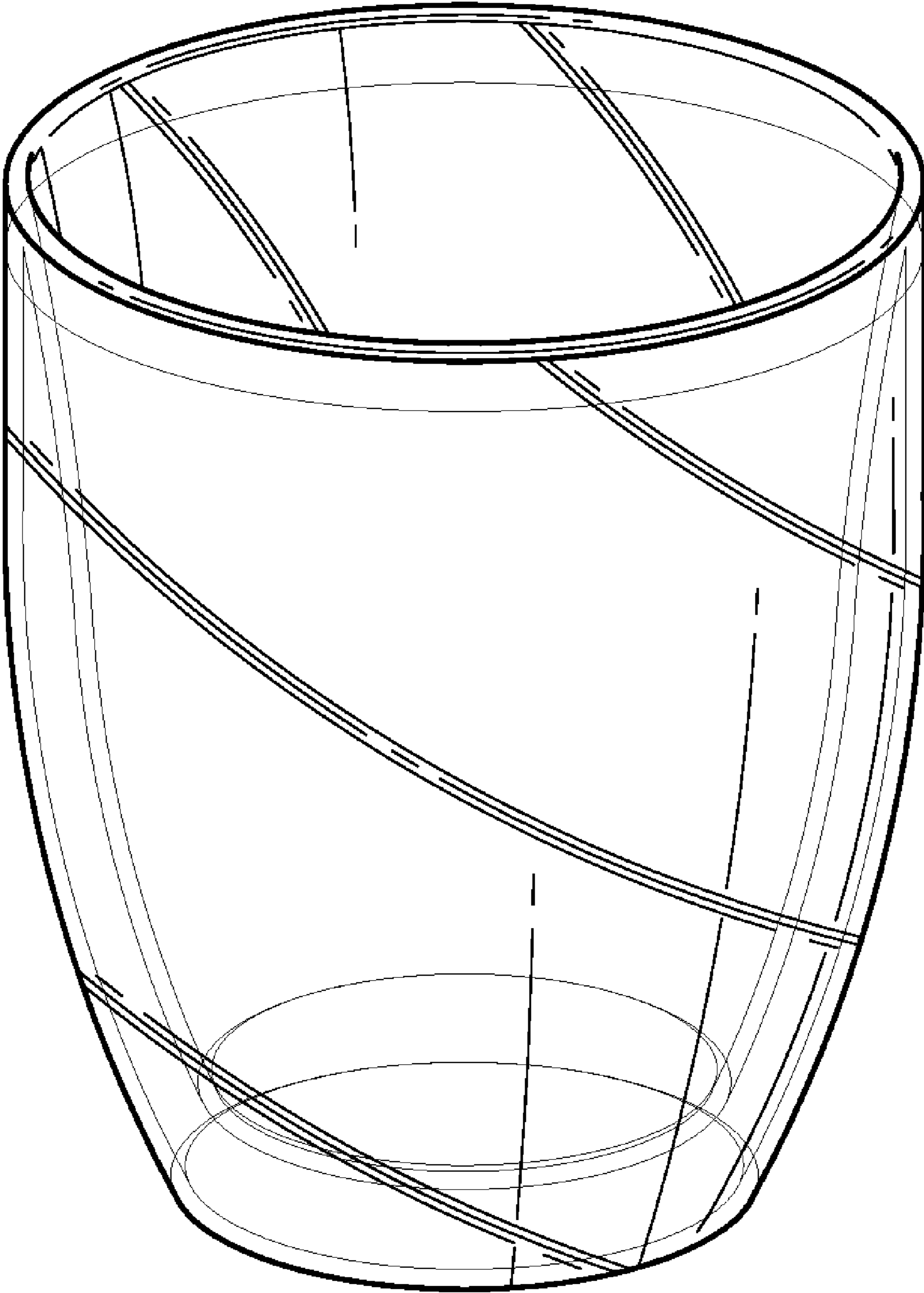

FIG. 1

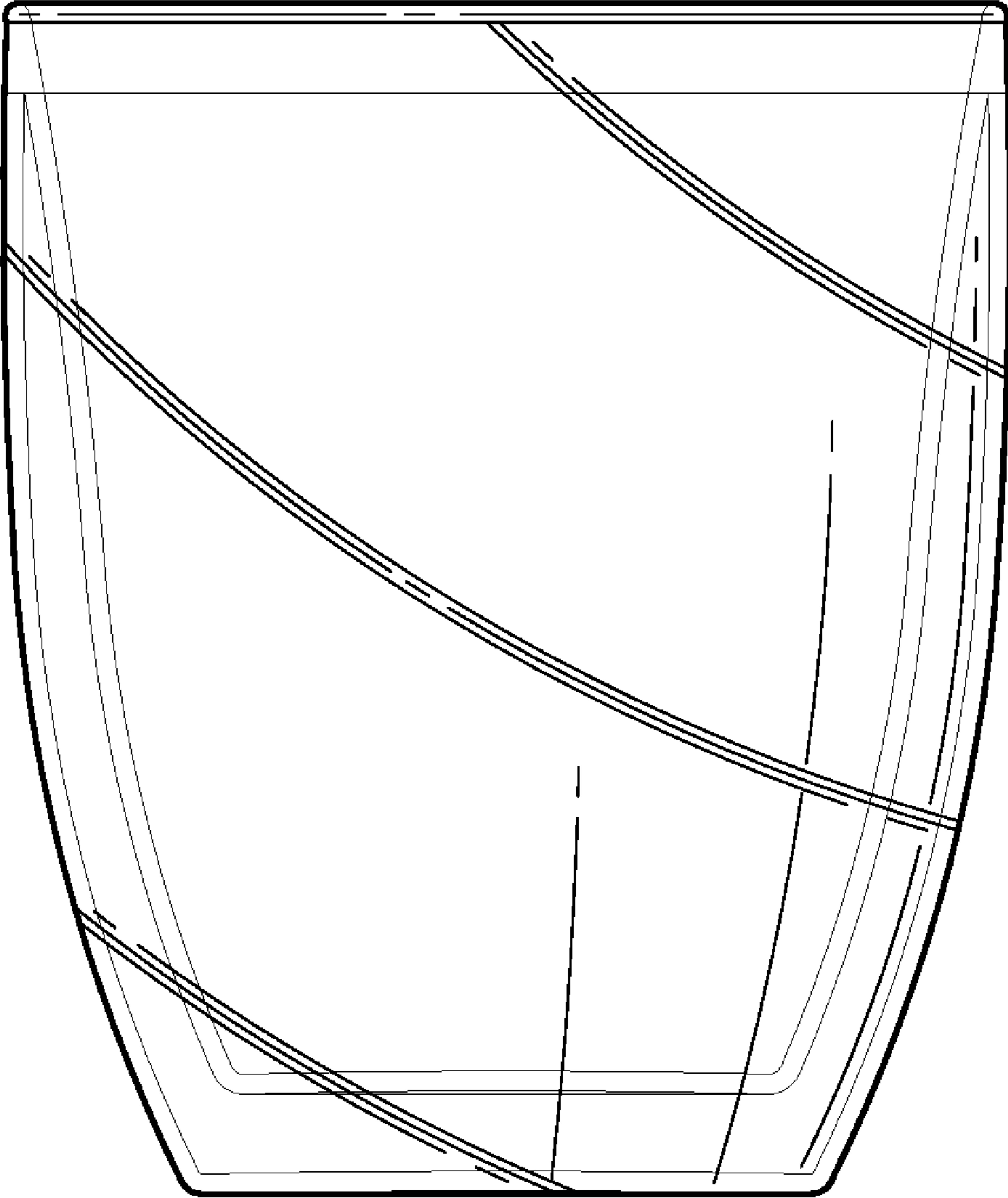
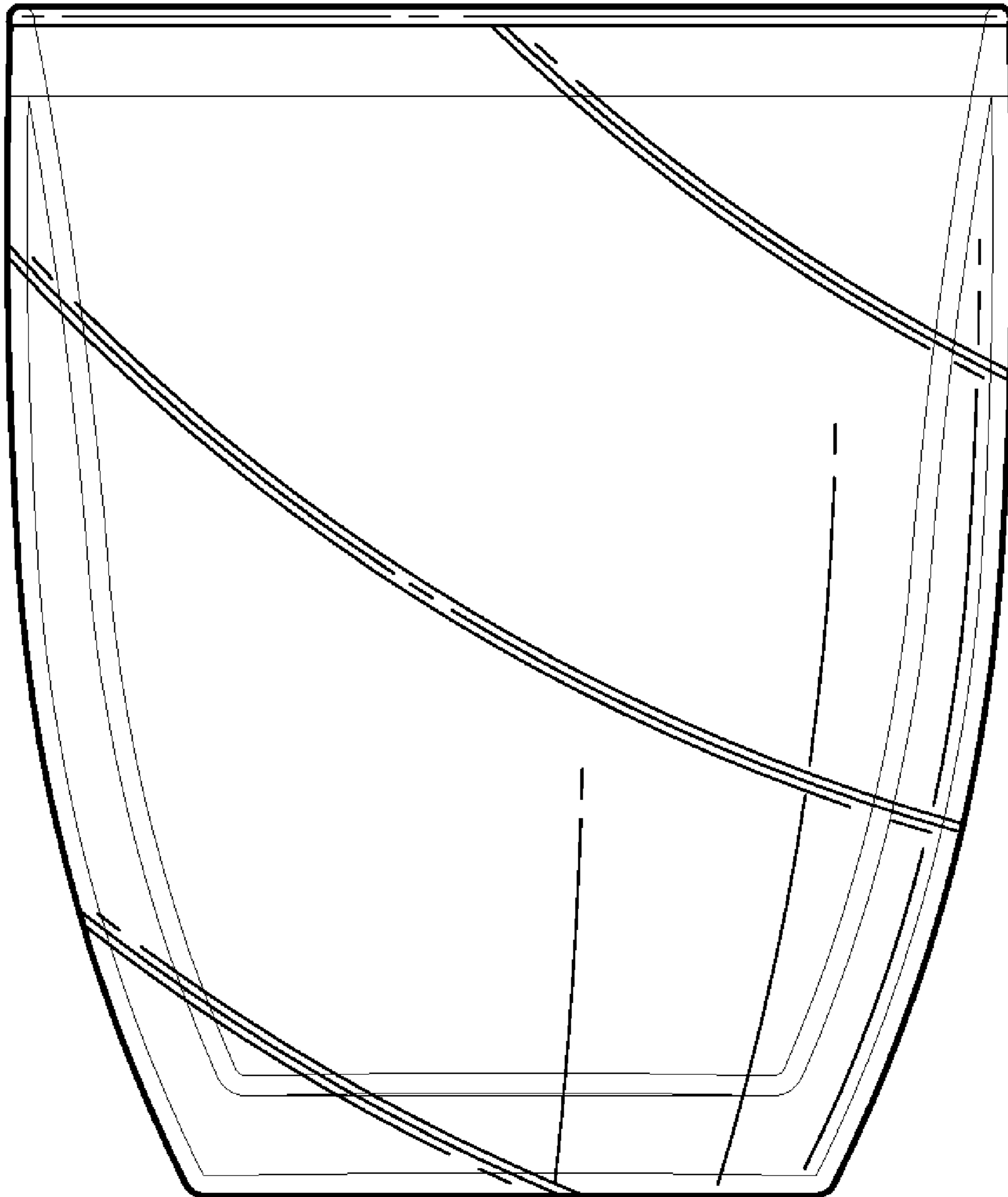

FIG. 2



**FIG. 3**

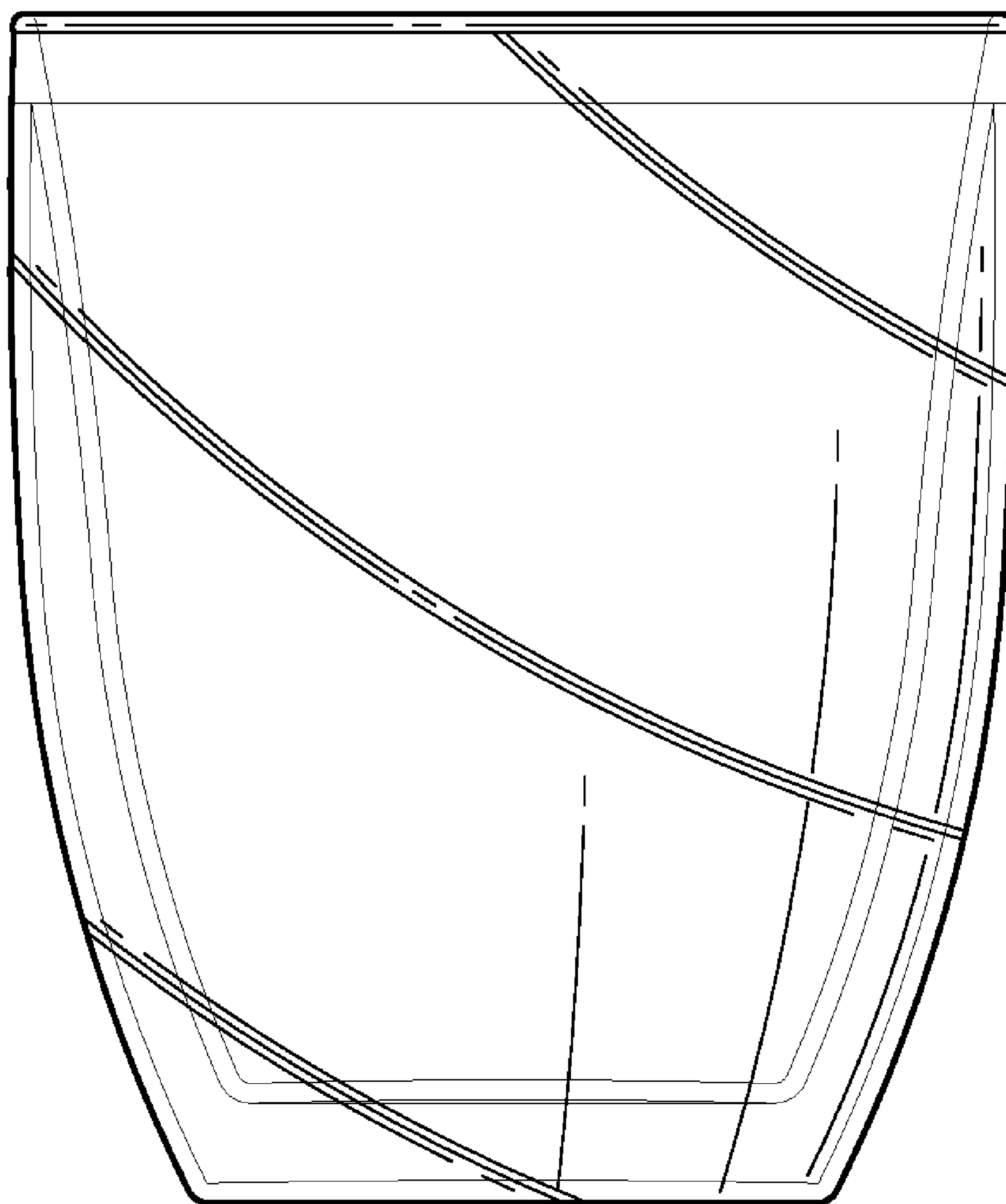
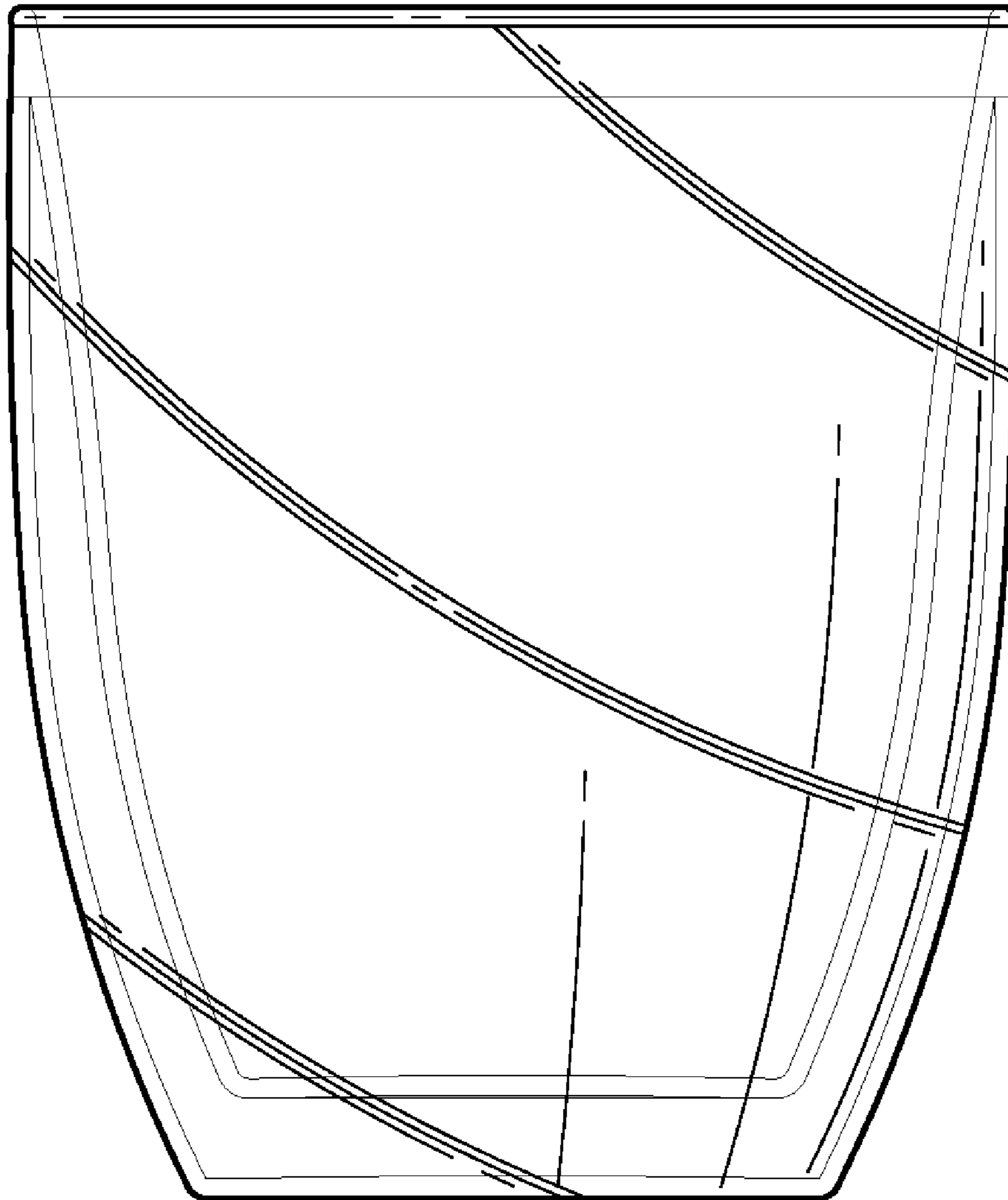

FIG. 4



**FIG. 5**

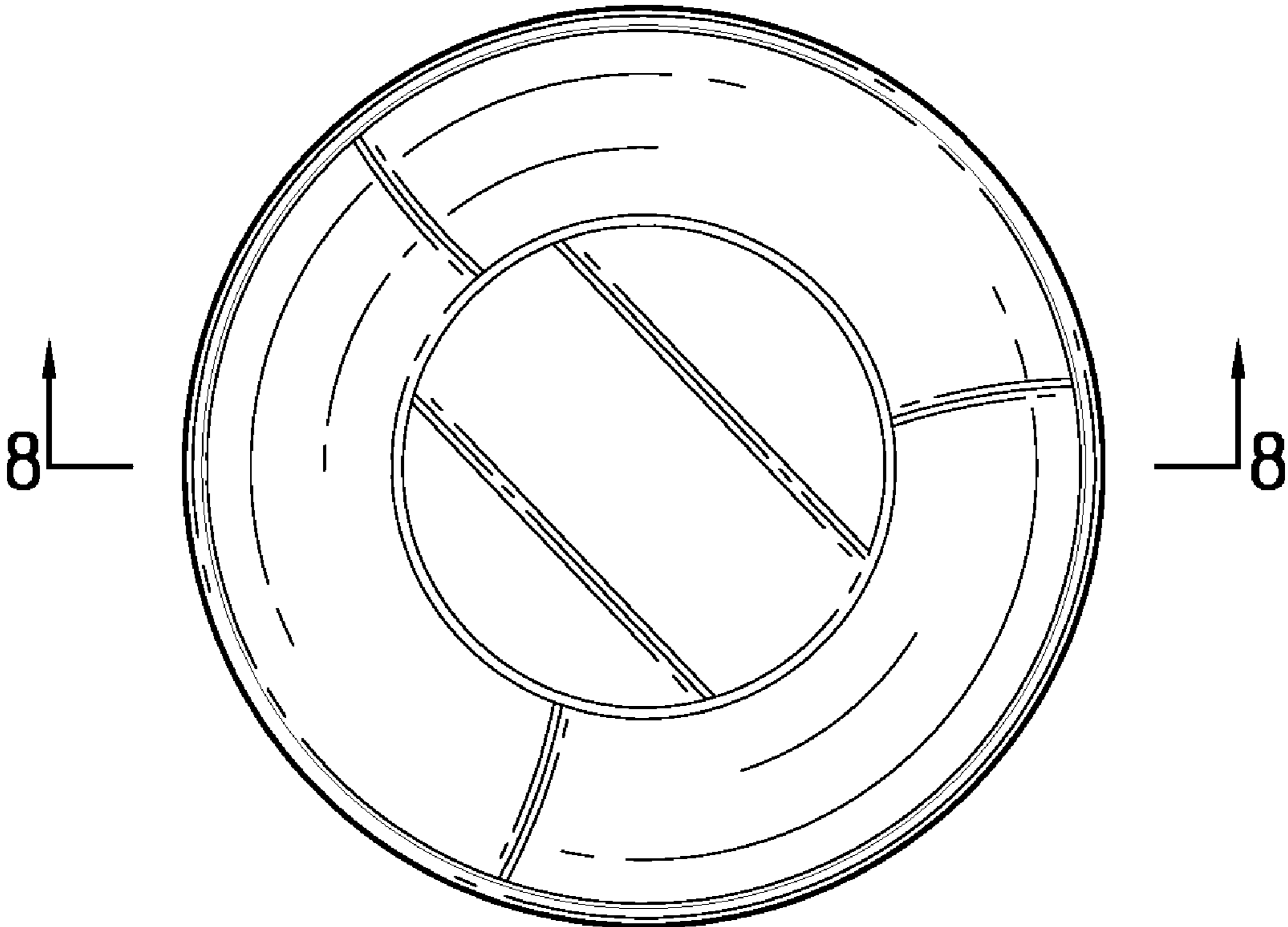

FIG. 6

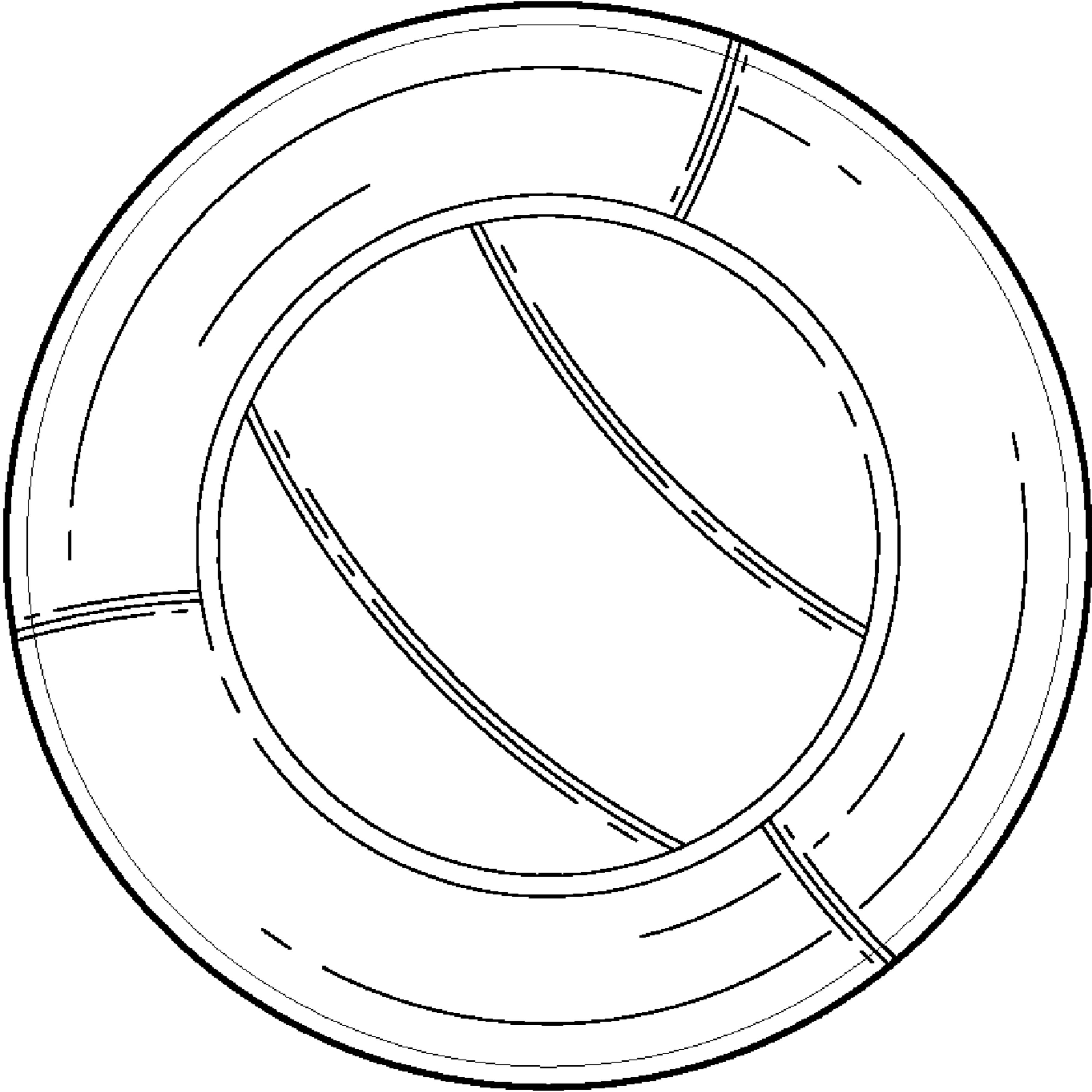

FIG. 7



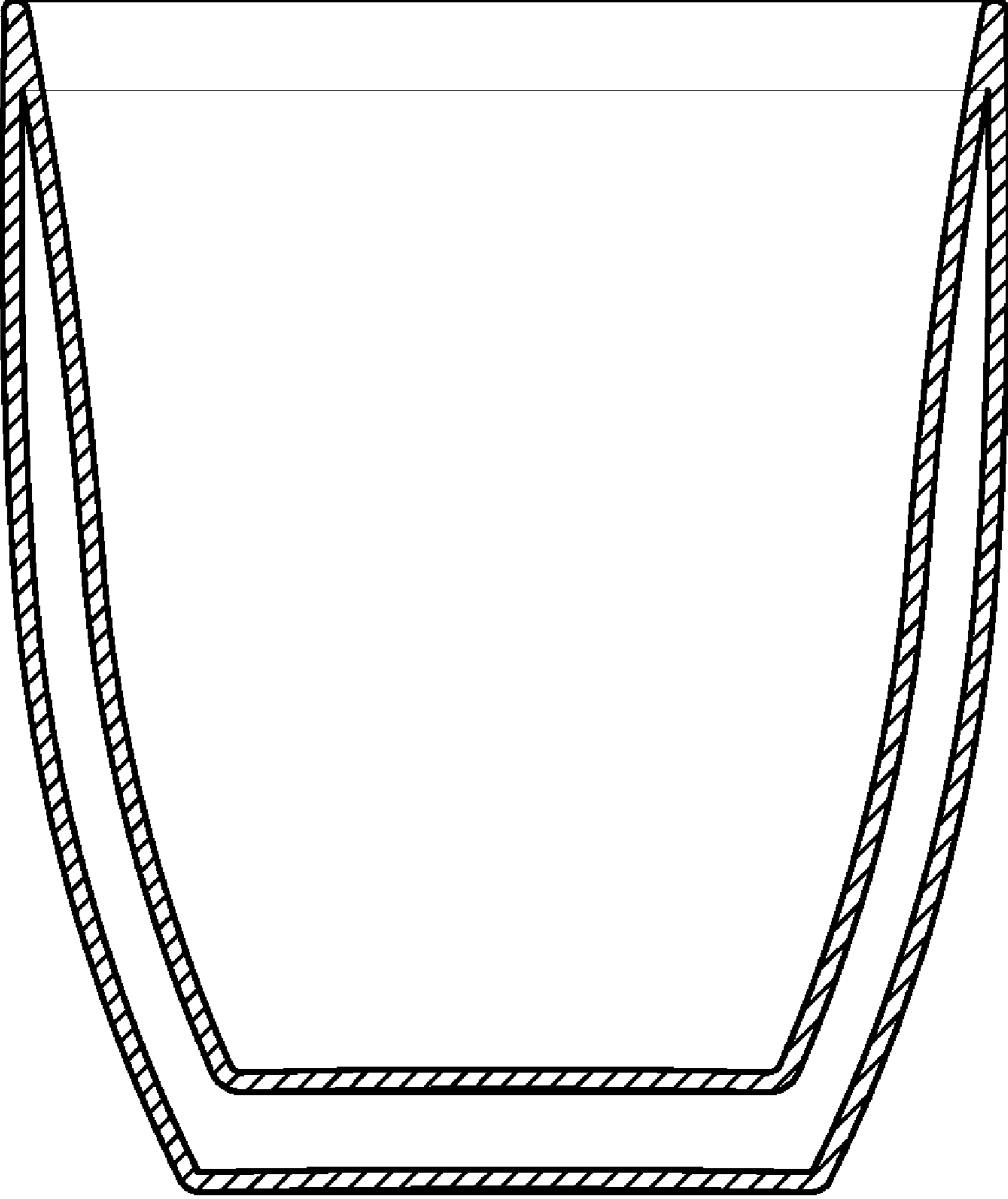

FIG. 8

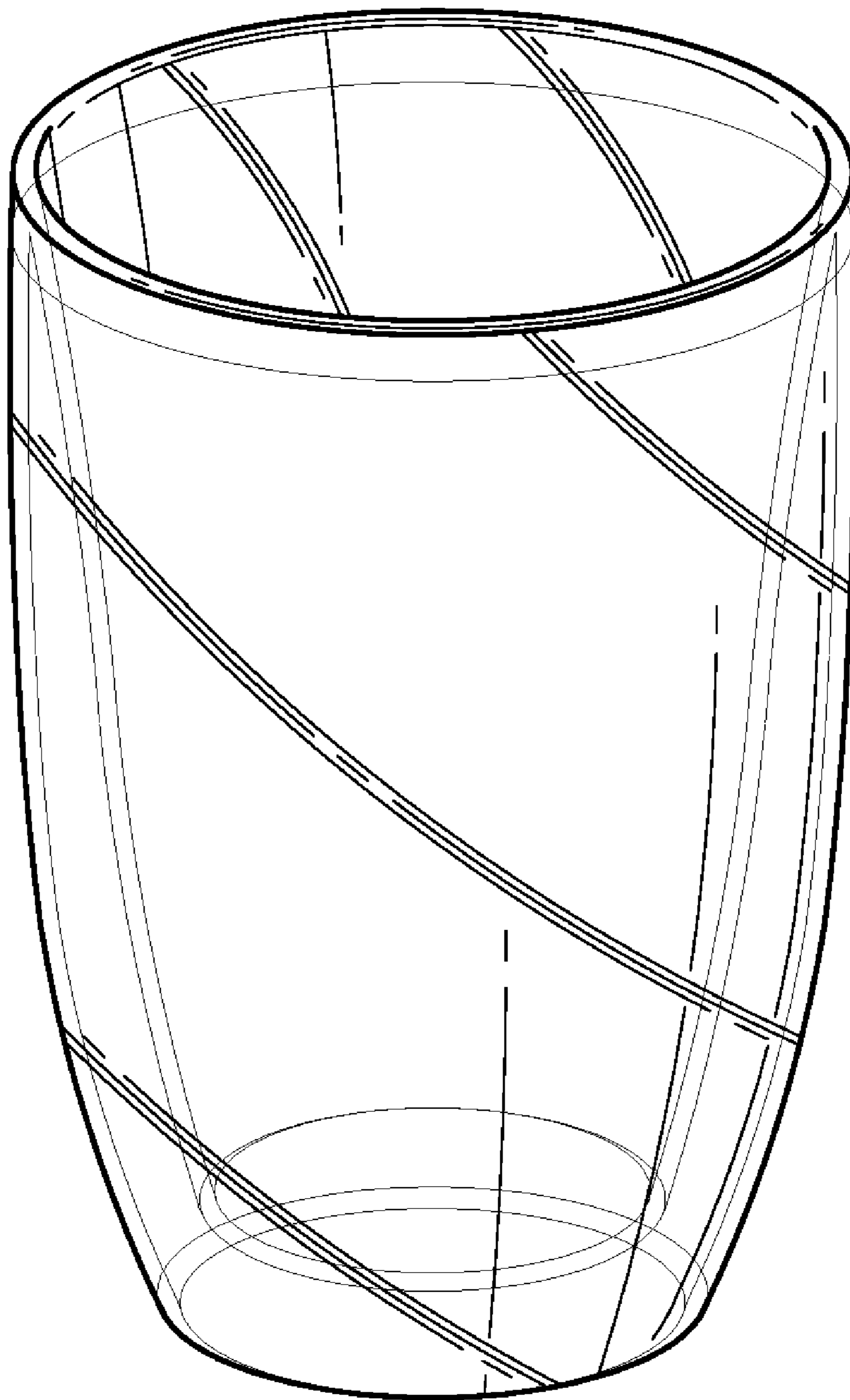
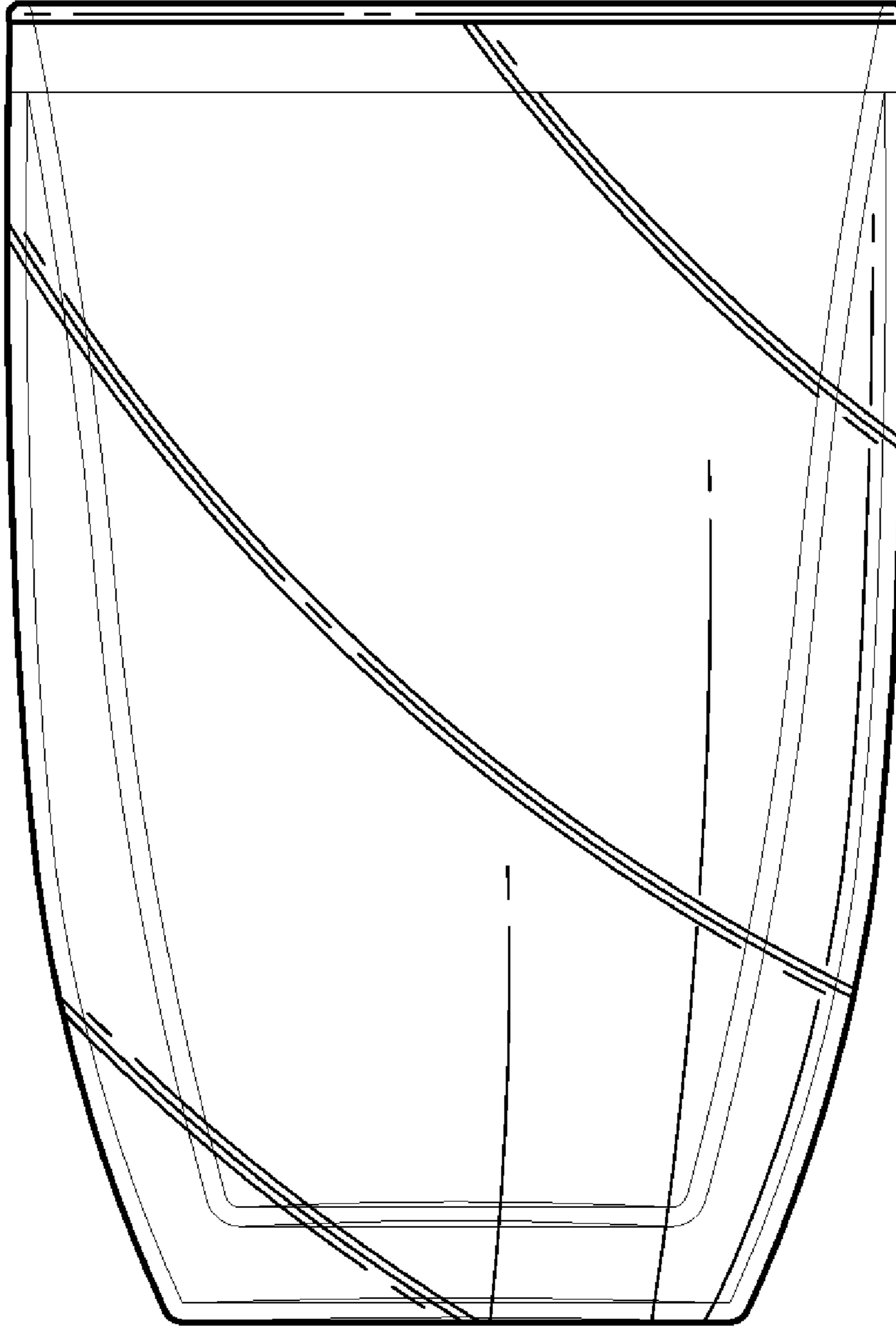
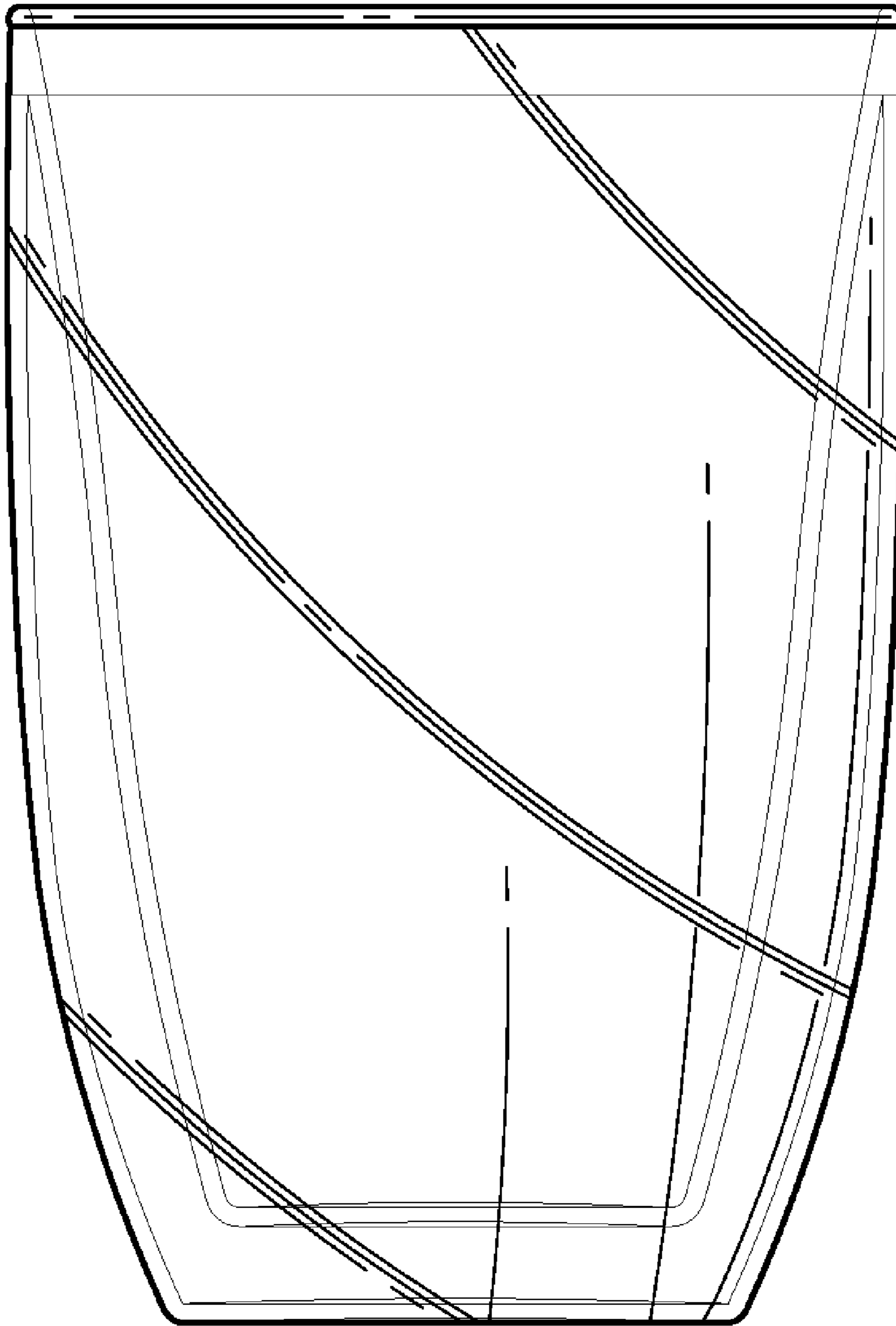

FIG. 9



**FIG. 10**



**FIG. 11**

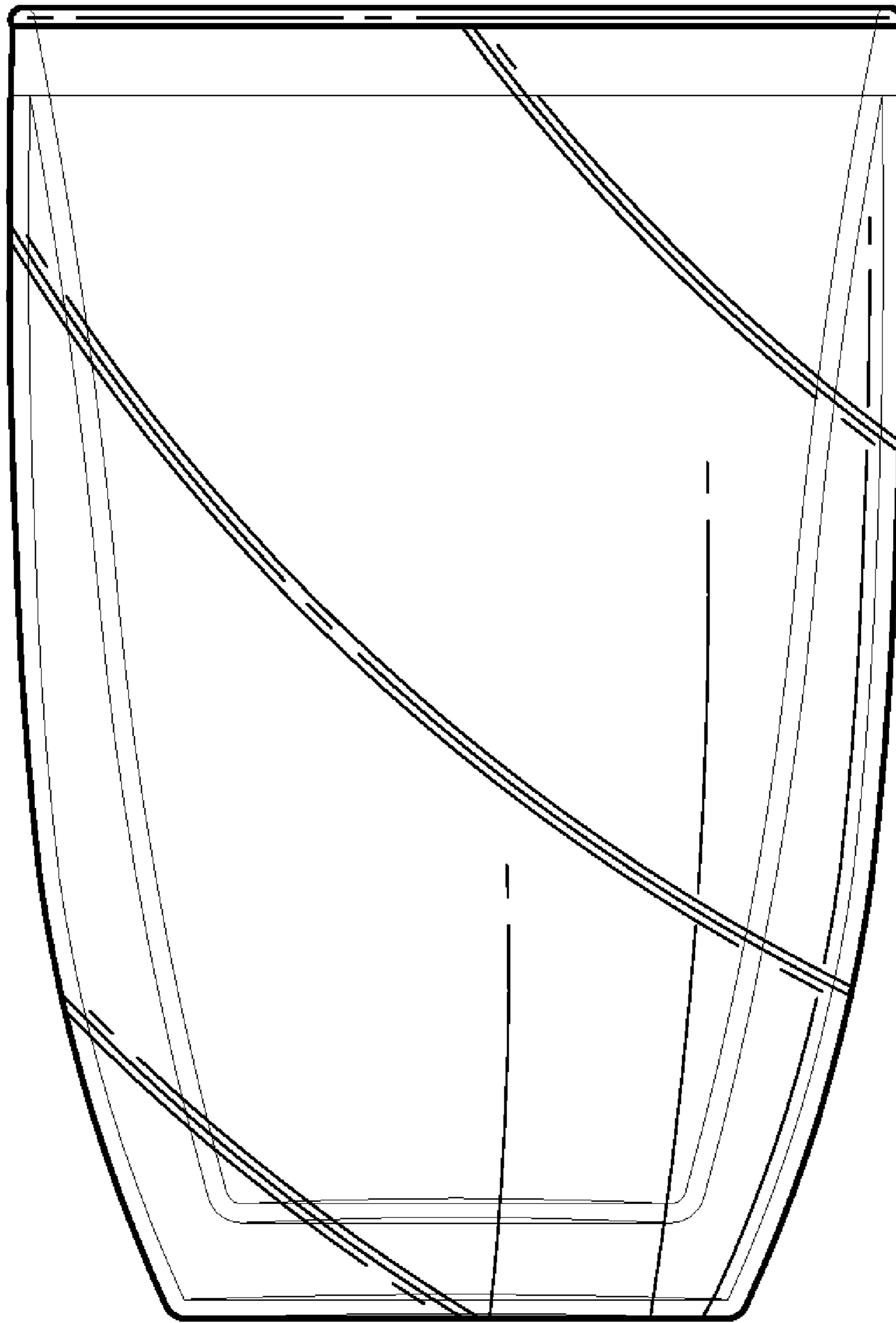

**FIG. 12**

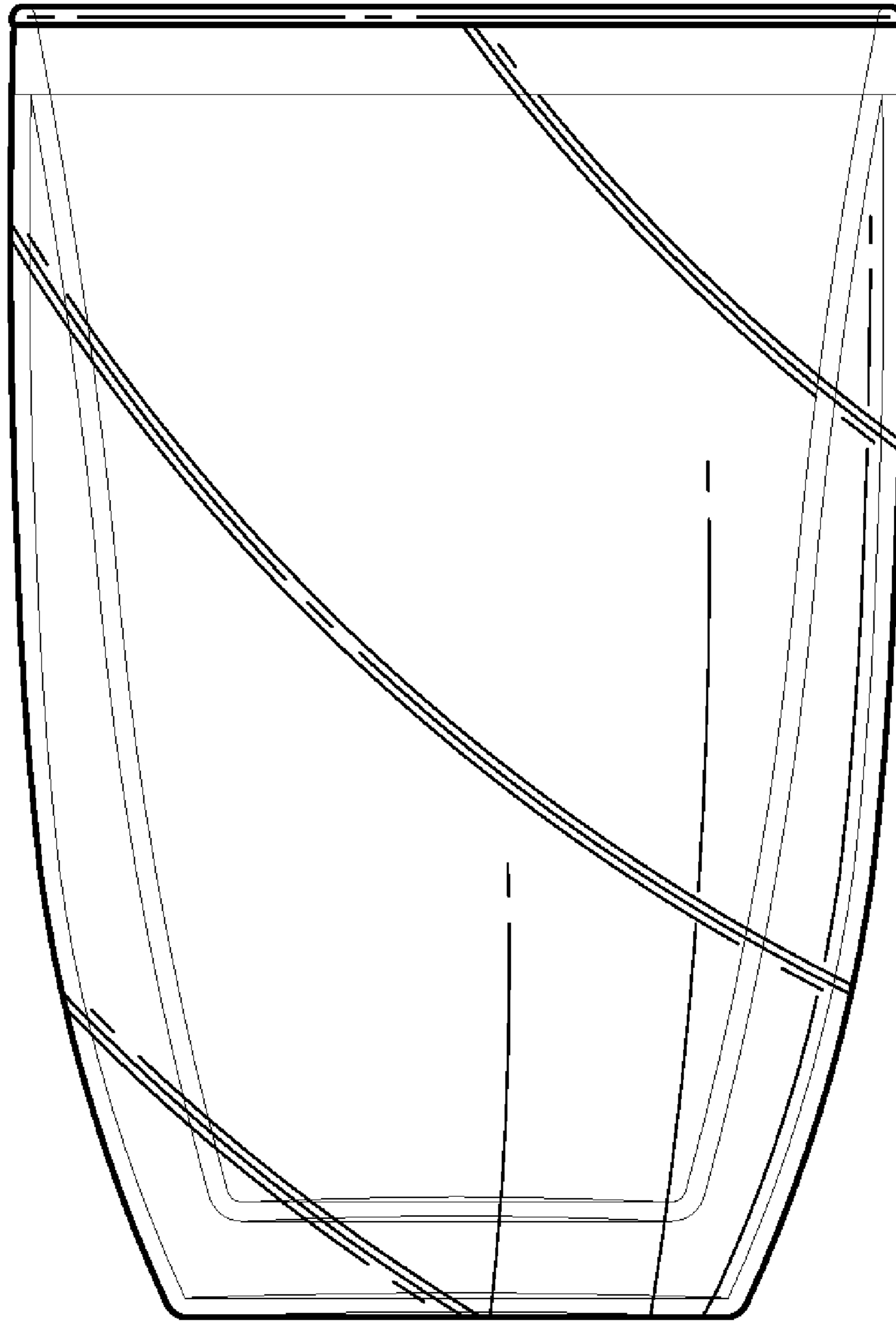

**FIG. 13**

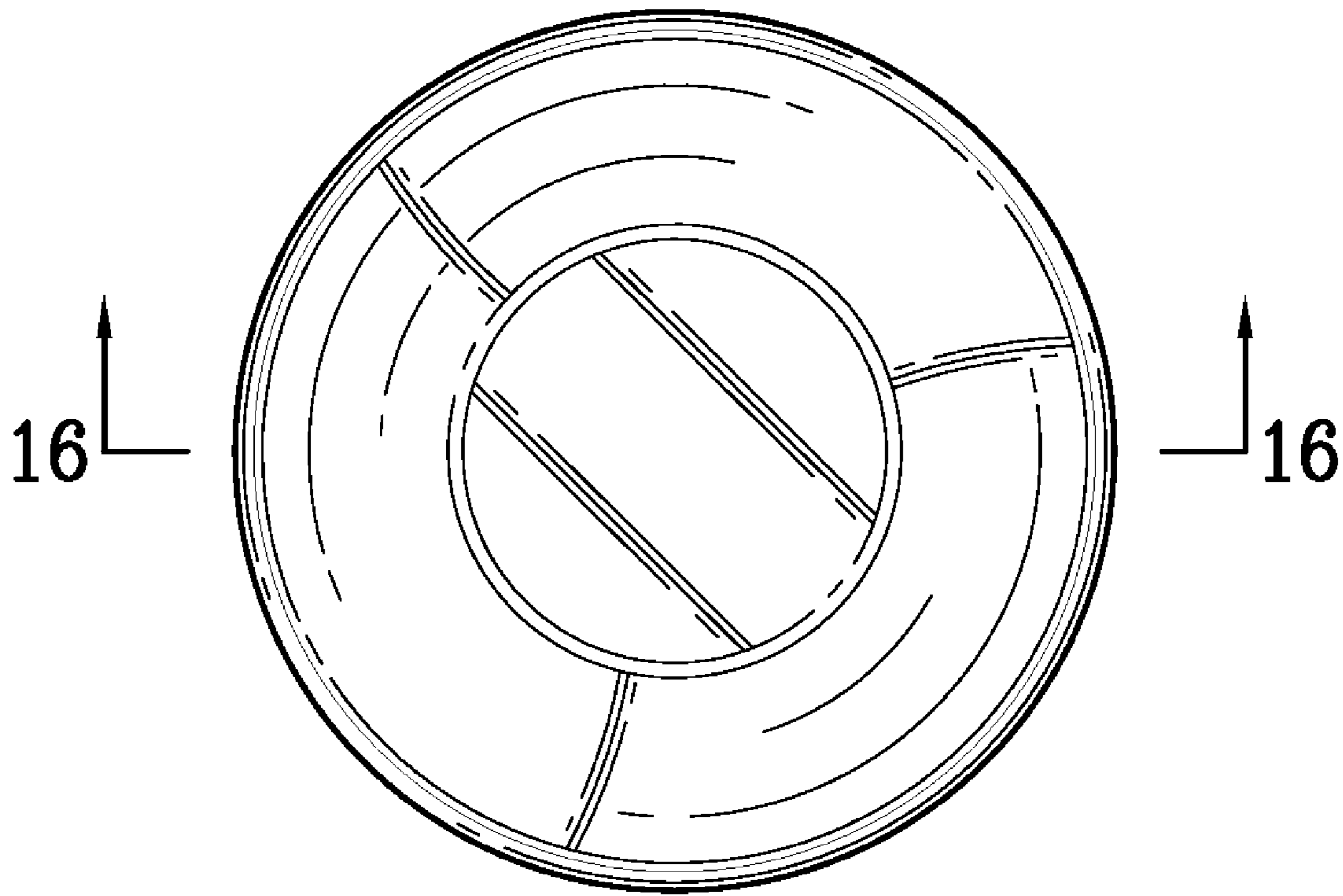
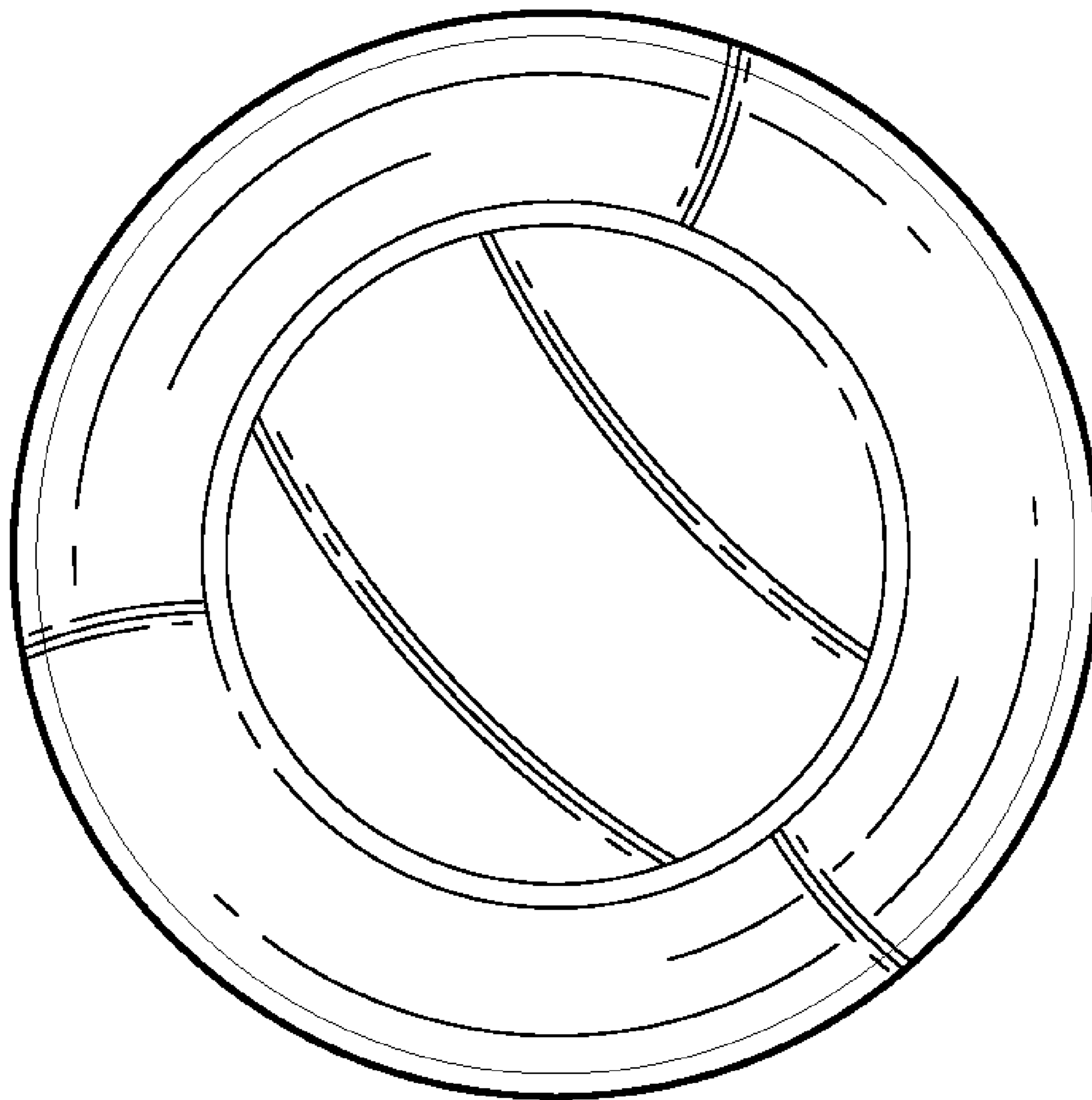
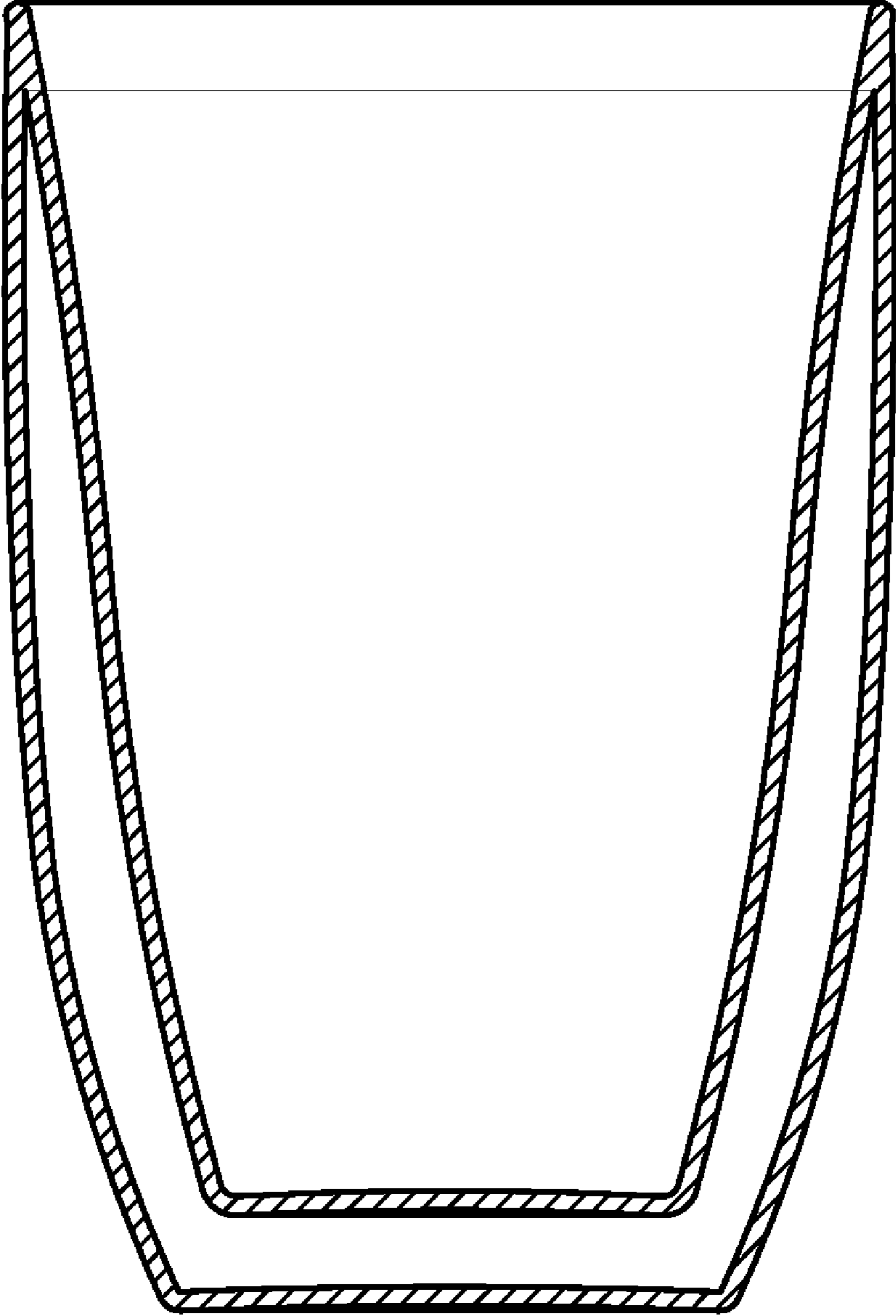

FIG. 14



**FIG. 15**





**FIG. 16**