



US00D553908S

(12) **United States Design Patent** (10) **Patent No.:** **US D553,908 S**  
**Bonini** (45) **Date of Patent:** **\*\* Oct. 30, 2007**

(54) **GROOVED WALL MUG, LID AND HOLDER**

(75) Inventor: **Santina Bonini**, Mid Levels (HK)

(73) Assignee: **Premier Merchandises Limited**, Kwai Chung-New Territories (HK)

(\*\*) Term: **14 Years**

(21) Appl. No.: **29/230,959**

(22) Filed: **May 27, 2005**

(30) **Foreign Application Priority Data**

Feb. 8, 2005 (HK) ..... 0500295

(51) **LOC (8) Cl.** ..... **07-01**

(52) **U.S. Cl.** ..... **D7/507; D7/532; D7/510**

(58) **Field of Classification Search** ..... D7/505,  
D7/624.1, 507, 509, 523, 532, 510, 511; 219/432;  
206/217; 215/387; 220/62.12, 703, 217  
See application file for complete search history.

(56) **References Cited**

**U.S. PATENT DOCUMENTS**

D70,476	S	*	6/1926	Heisey	.....	D7/532
D107,989	S	*	1/1938	Hansen	.....	D7/532
D107,991	S	*	1/1938	Hansen	.....	D7/532
D108,421	S	*	2/1938	Brill	.....	D7/532
D120,134	S	*	4/1940	Morrison	.....	D7/532
D160,259	S	*	9/1950	Gustkey	.....	D7/532
2,592,485	A	*	4/1952	Stair	.....	366/130
D228,721	S	*	10/1973	Todd	.....	D7/624.1
4,040,549	A	*	8/1977	Sadler	.....	224/483
4,224,764	A	*	9/1980	Dziewulski et al.	.....	47/71
D333,756	S	*	3/1993	Campbell	.....	D7/507
D359,196	S	*	6/1995	Nichols	.....	D7/570
5,531,353	A	*	7/1996	Ward et al.	.....	220/729
D375,659	S	*	11/1996	Lipic	.....	D7/624.1
D376,728	S	*	12/1996	Richards et al.	.....	D7/507
D378,619	S	*	3/1997	Ng	.....	D26/38

(Continued)

*Primary Examiner*—M. N. Pandozzi  
(74) *Attorney, Agent, or Firm*—Lipsitz & McAllister, LLC

(57) **CLAIM**

The ornamental design for a grooved wall mug, lid and holder, as shown and described.

**DESCRIPTION**

FIG. 1 is a top front perspective view of a grooved wall mug, lid, and holder showing my new design;

FIG. 2 is a front elevational view thereof;

FIG. 3 is a top plan view thereof;

FIG. 4 is a left side elevational view thereof;

FIG. 5 is a rear elevational view thereof;

FIG. 6 is a bottom plan view thereof;

FIG. 7 is an exploded left side elevational view thereof;

FIG. 8 is a side elevational view of the mug portion of the grooved wall mug, lid and holder with the lid and holder removed for ease of illustration;

FIG. 9 is a top plan view thereof;

FIG. 10 is a bottom plan view thereof;

FIG. 11 is a top plan view of the lid portion of the grooved wall mug, lid and holder with the mug and holder removed for ease of illustration;

FIG. 12 is a bottom plan view thereof;

FIG. 13 is a left side elevational view thereof;

FIG. 14 is a front elevational view thereof;

FIG. 15 is a rear elevational view thereof;

FIG. 16 is a top plan view of the holder portion of the grooved wall mug, lid, and holder with the mug and lid portion removed for ease of illustration;

FIG. 17 is a bottom plan view thereof; and,

FIG. 18 is a side elevational view thereof.

**1 Claim, 9 Drawing Sheets**

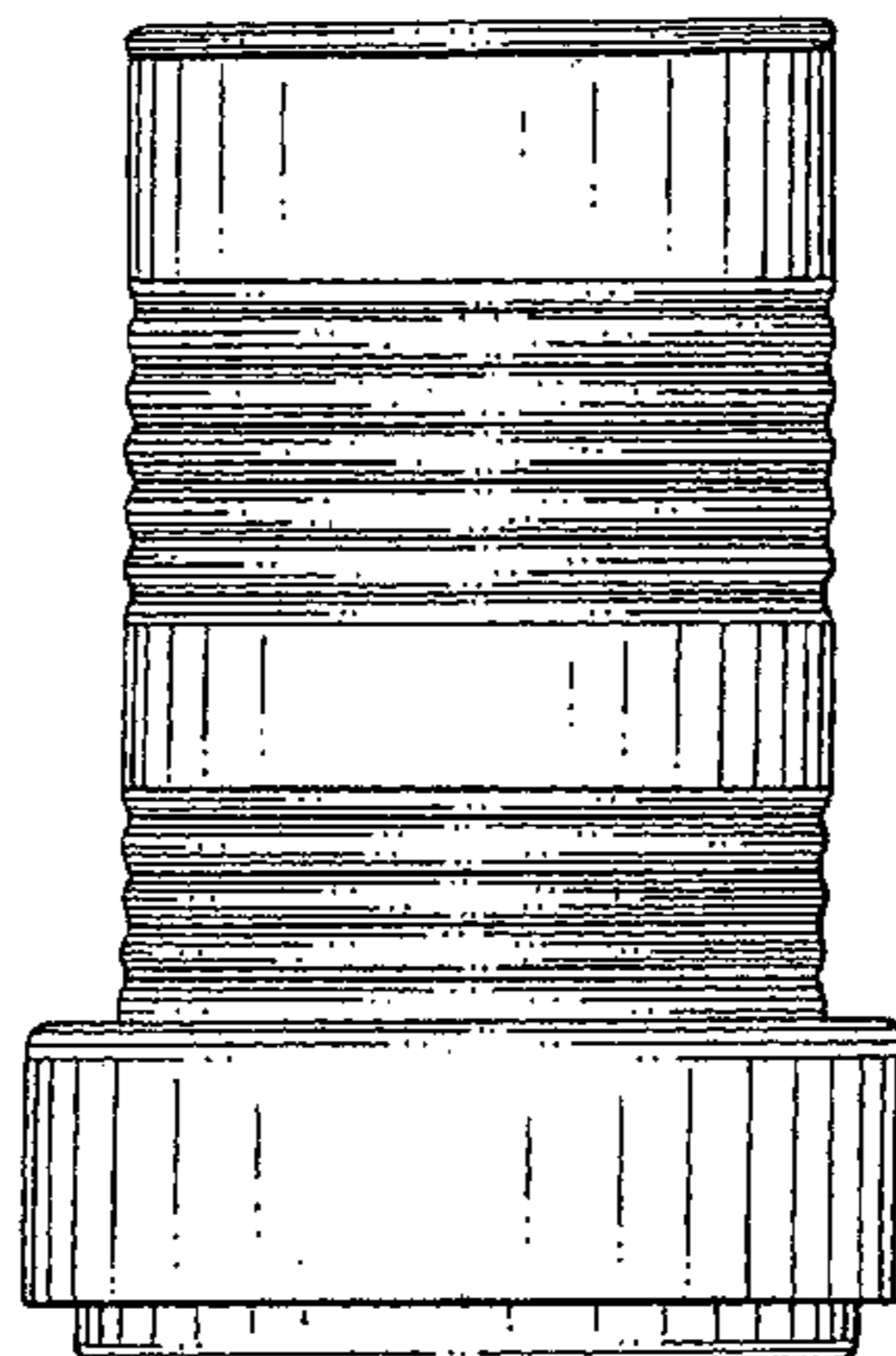
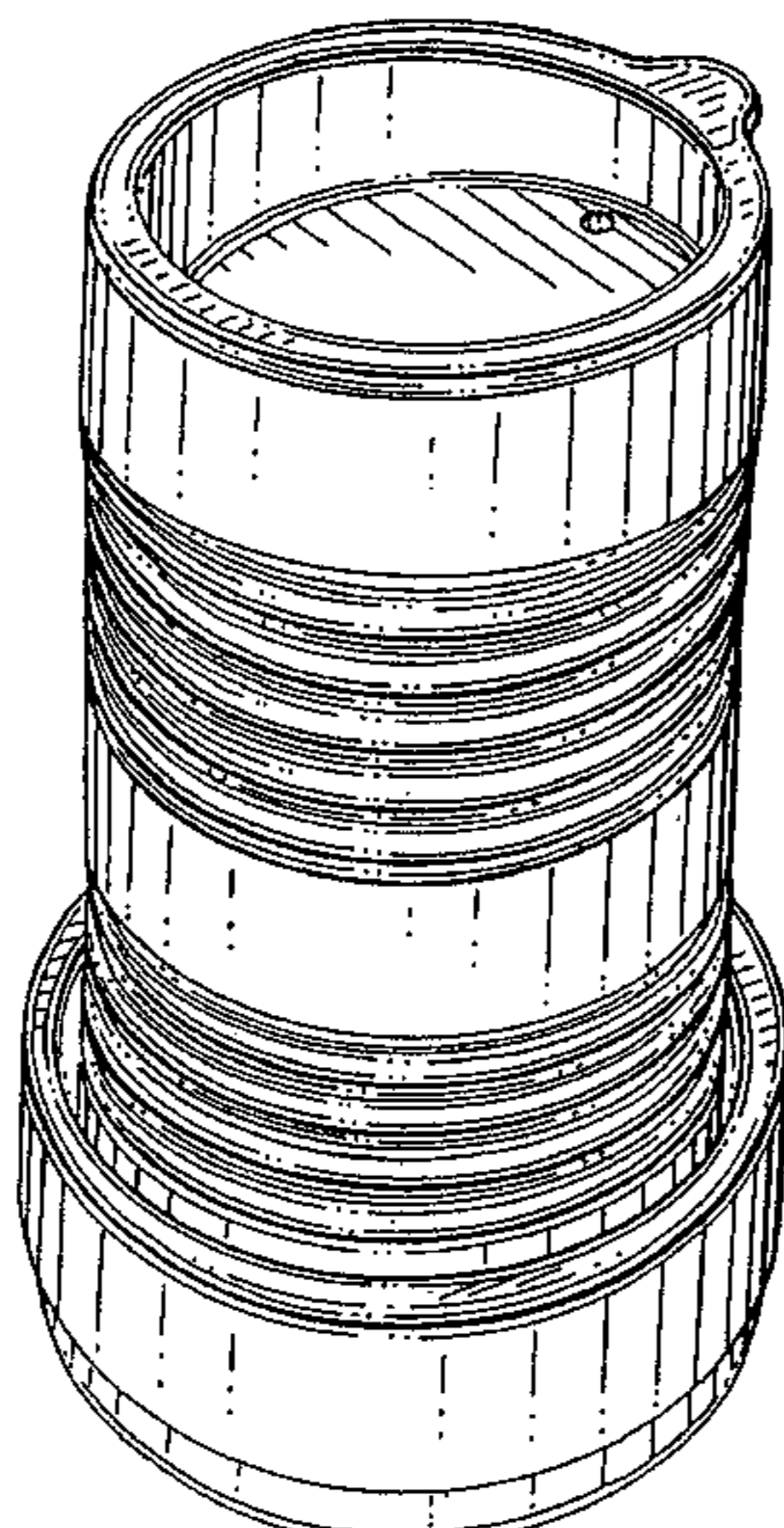

# US D553,908 S

Page 2

---

## U.S. PATENT DOCUMENTS

D410,174 S *	5/1999	Sheu .....	D7/510	D476,528 S *	7/2003	Janky et al. ....	D7/536
D417,590 S *	12/1999	Kato .....	D7/510	D497,079 S *	10/2004	Paggio .....	D7/507
D460,895 S *	7/2002	Lin .....	D7/533	6,834,838 B2 *	12/2004	Dennis et al. ....	248/311.2
D462,875 S *	9/2002	Norris et al. ....	D7/533	D503,072 S *	3/2005	Norris et al. ....	D7/532
6,450,363 B1 *	9/2002	Lin .....	220/758	D534,038 S *	12/2006	Kramer et al. ....	D7/510

\* cited by examiner

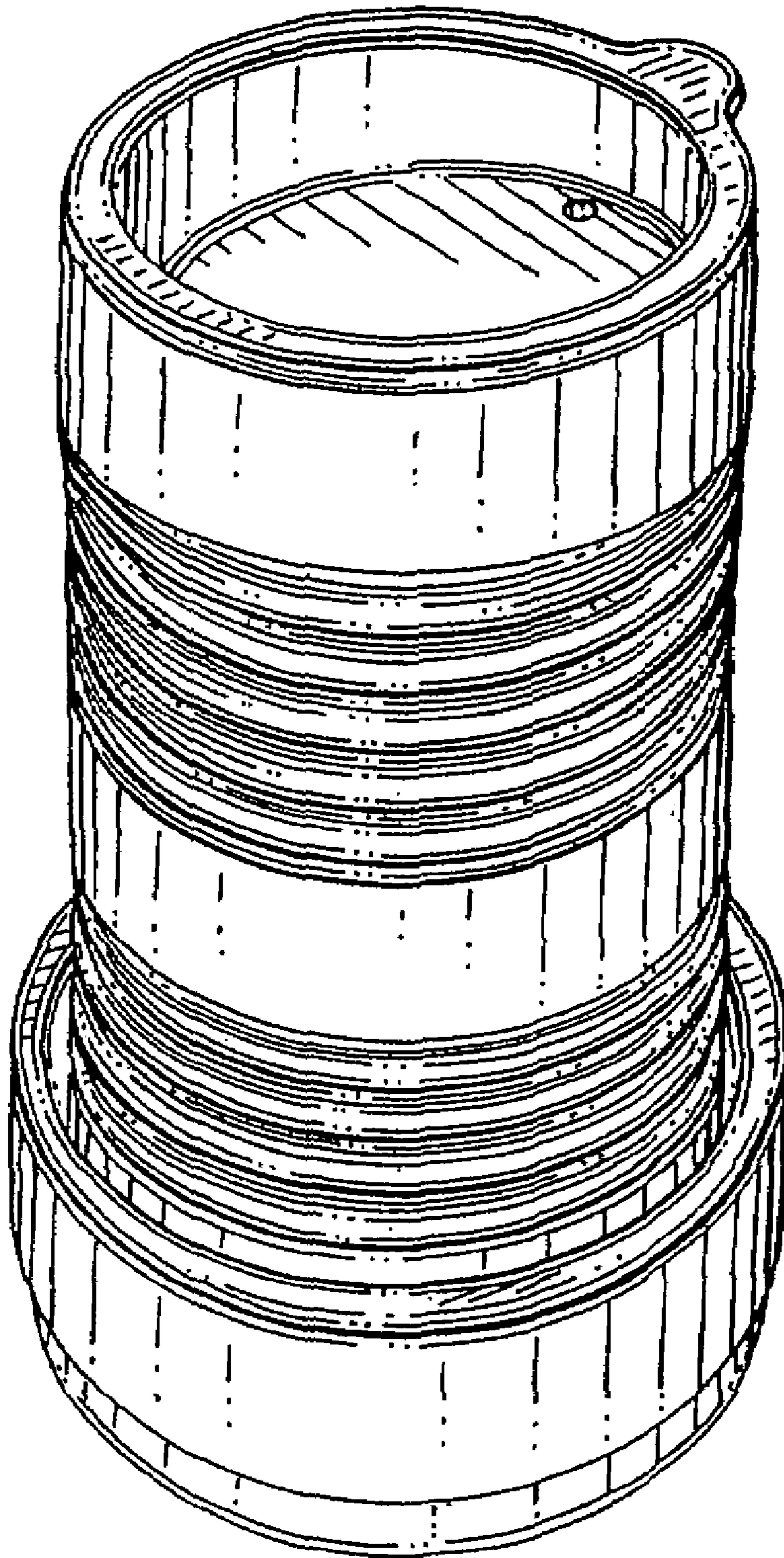

FIG. 1

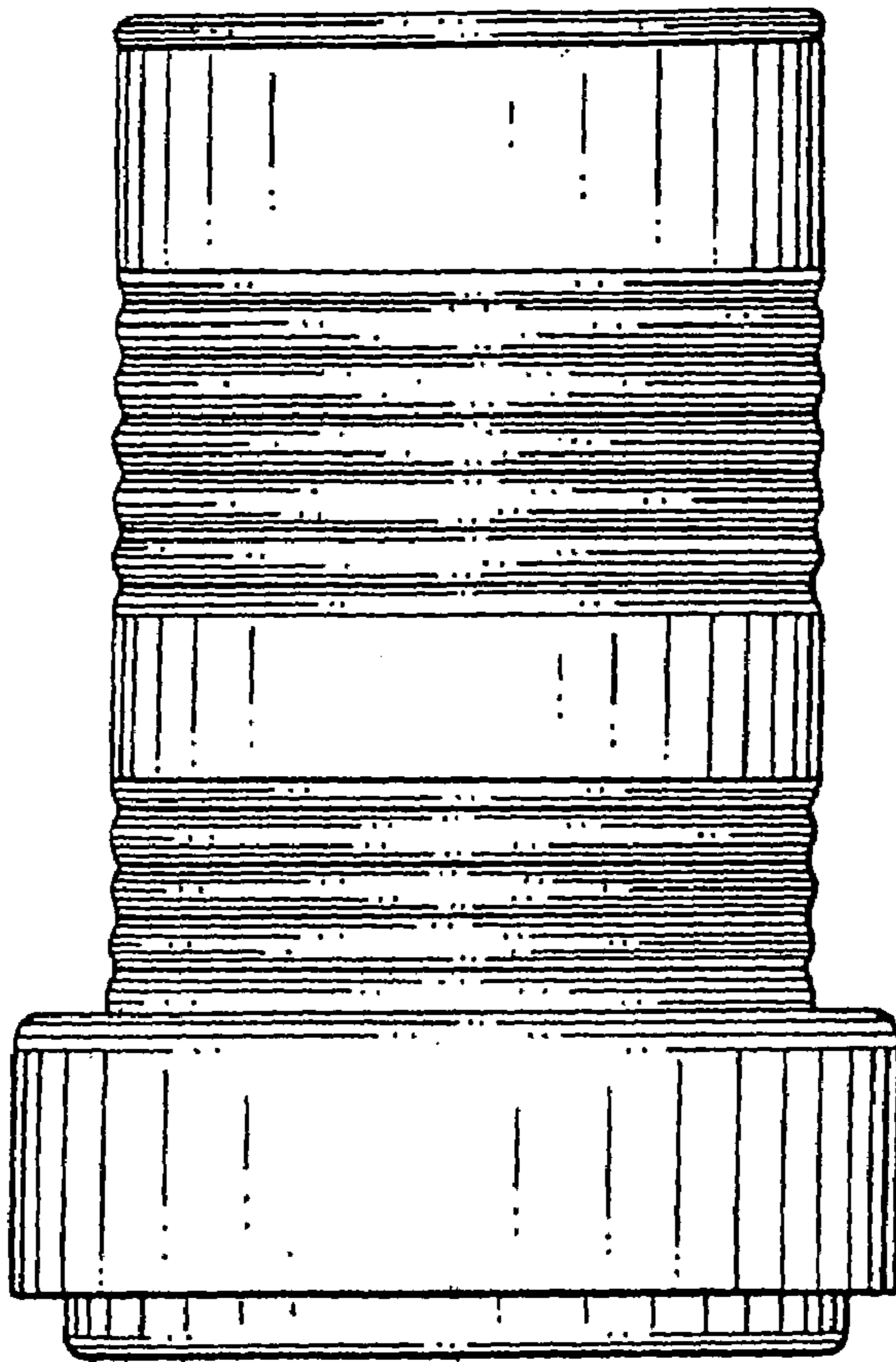

FIG. 2

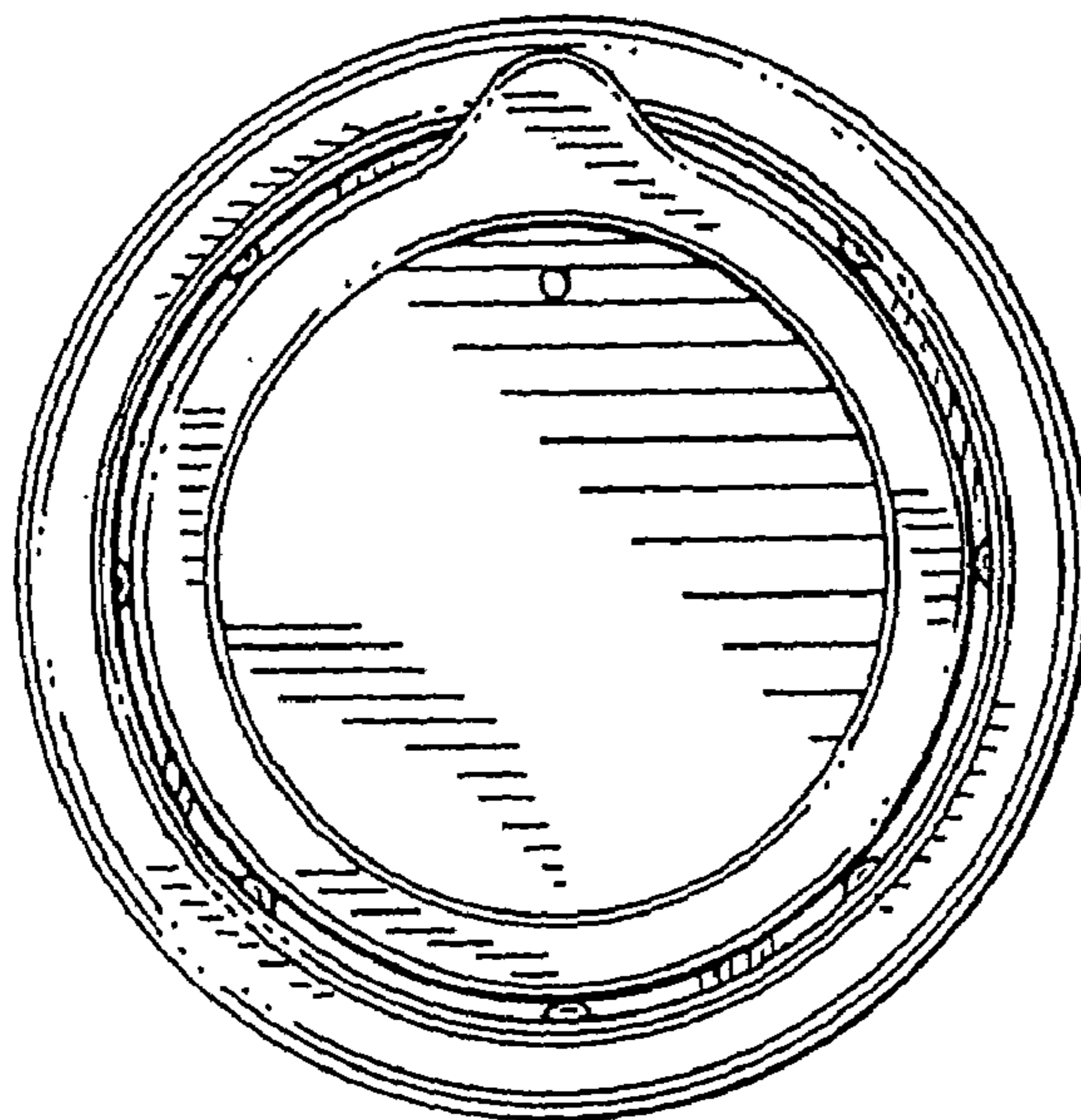
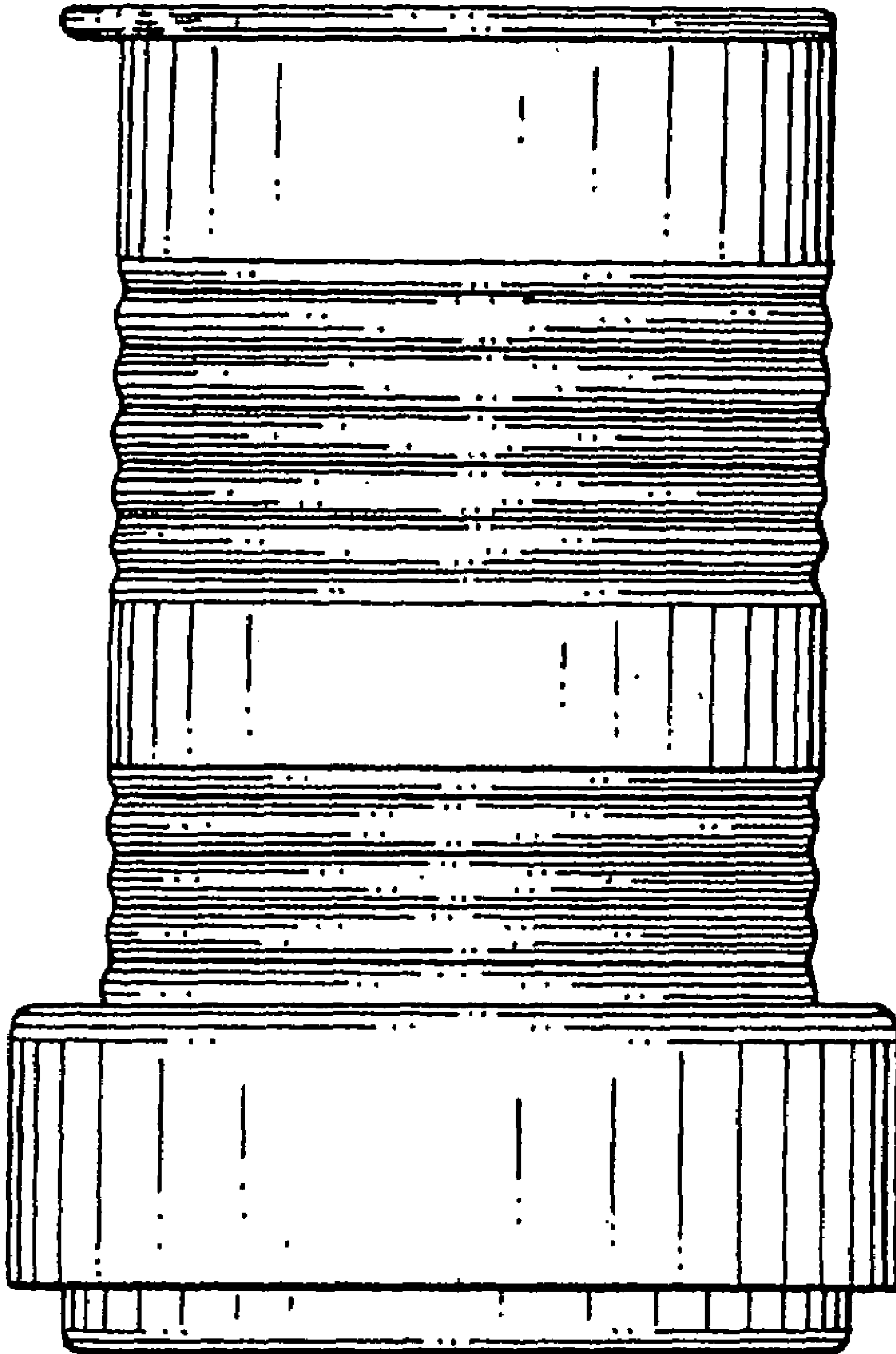

FIG. 3

# FIG. 4



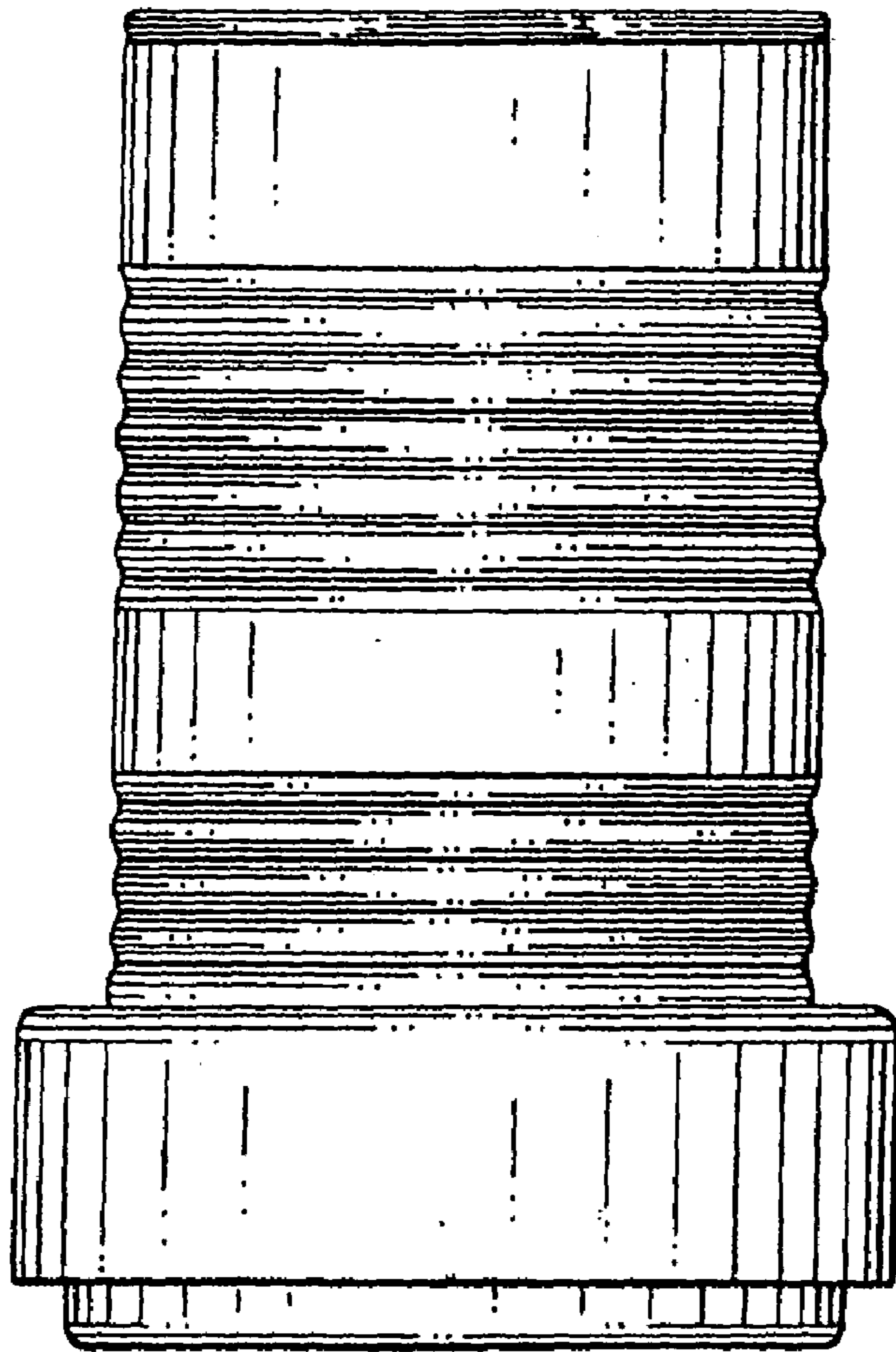

FIG. 5

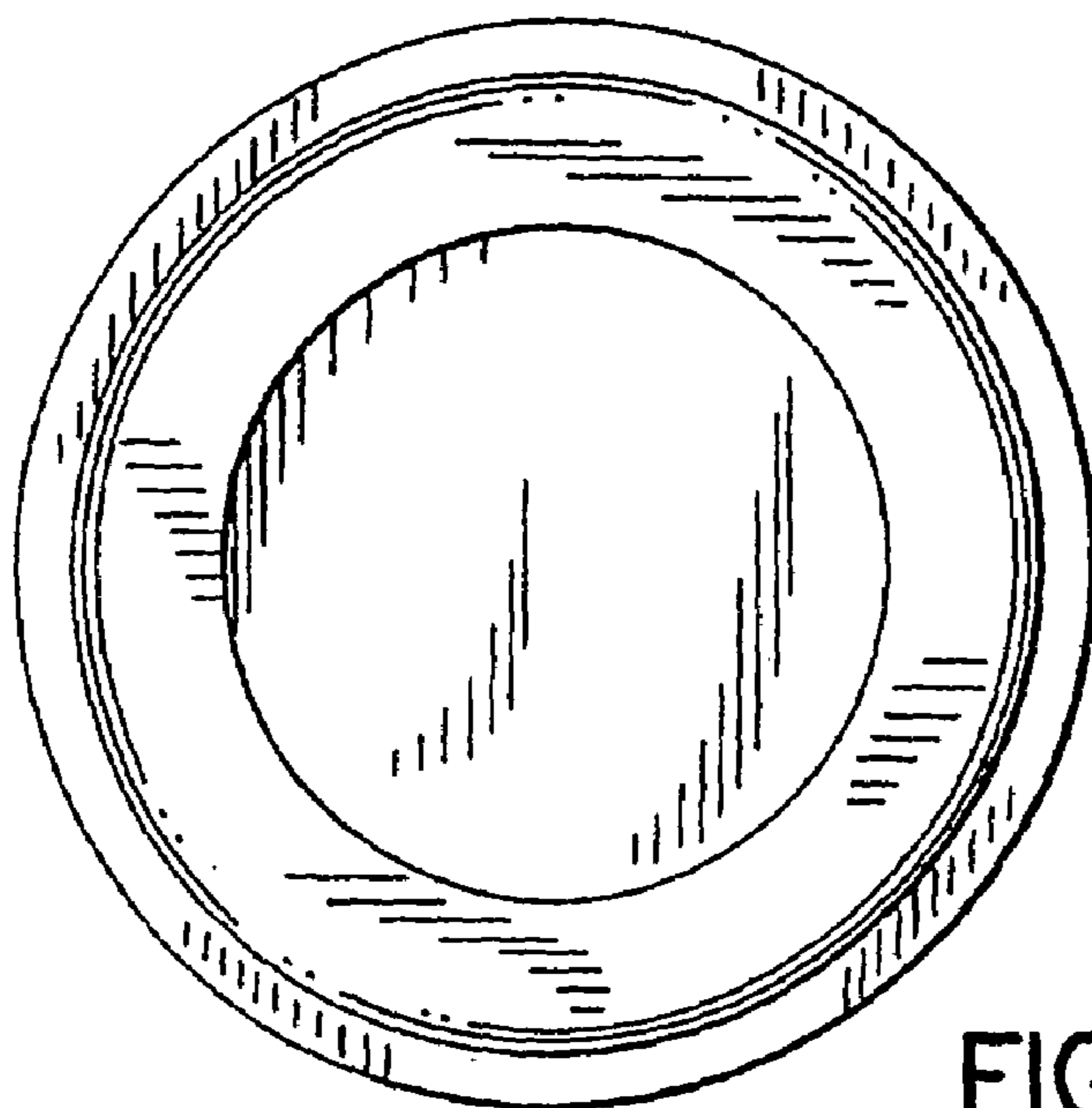
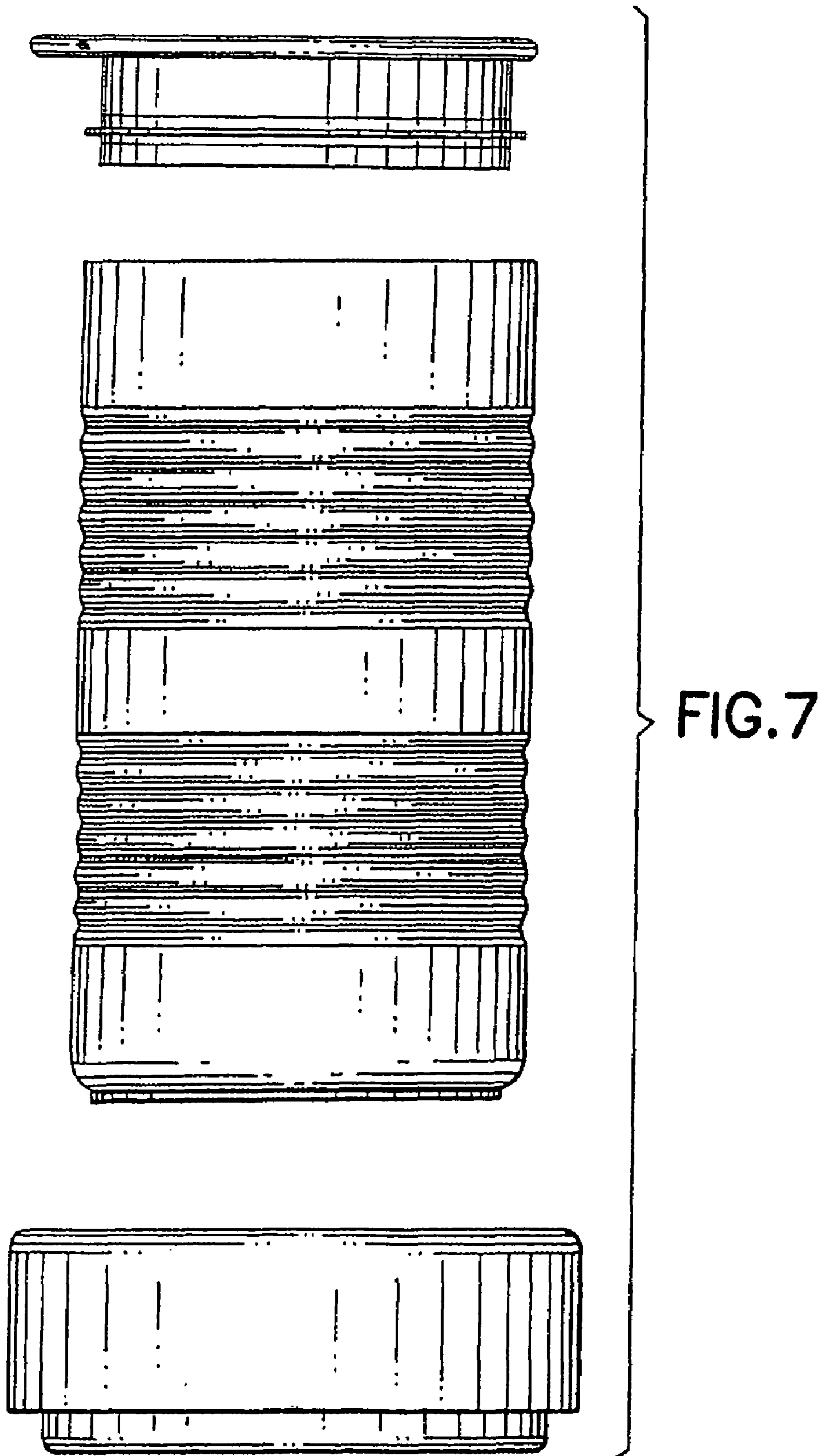

FIG. 6



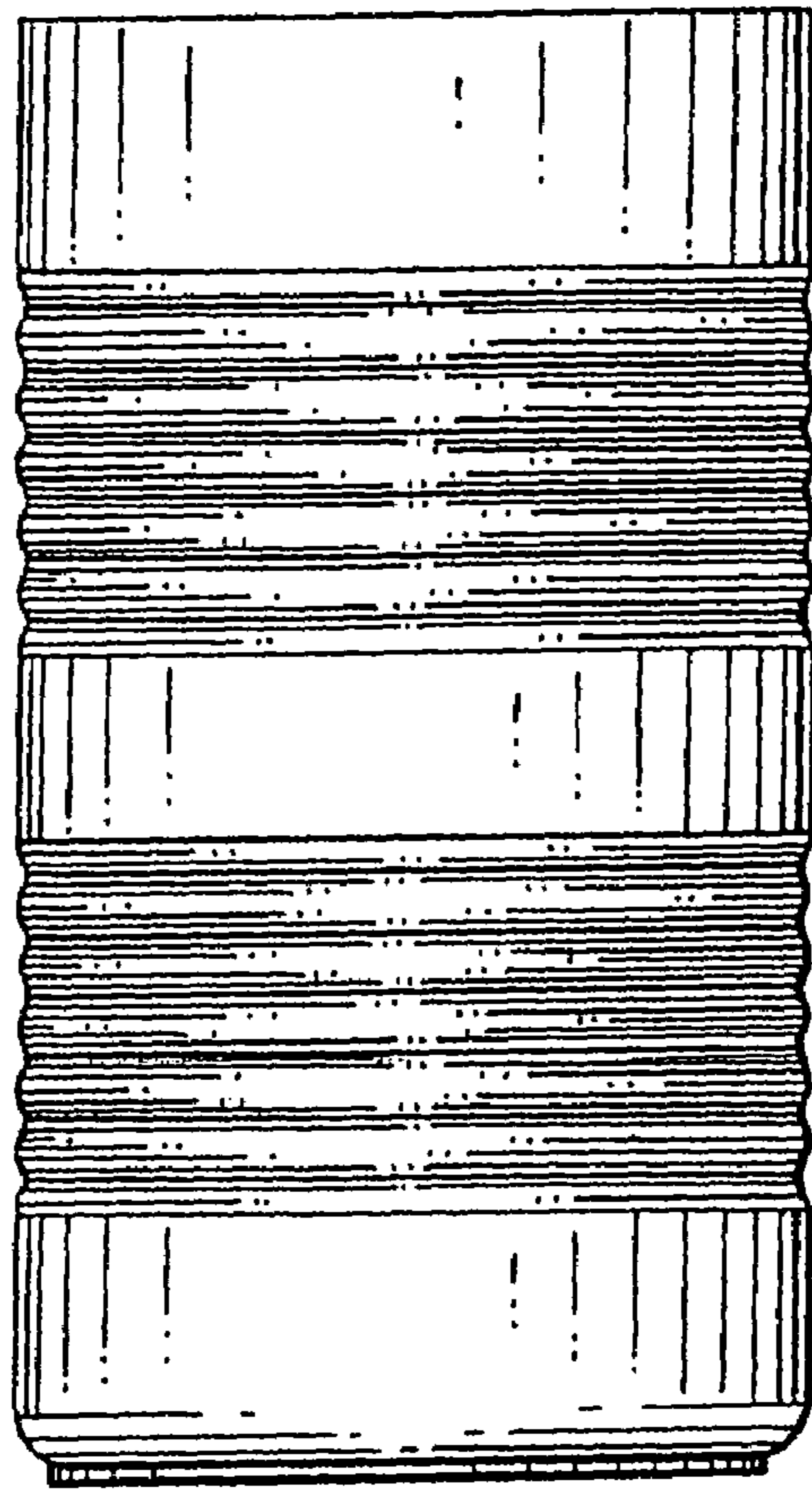

FIG. 8

FIG. 9

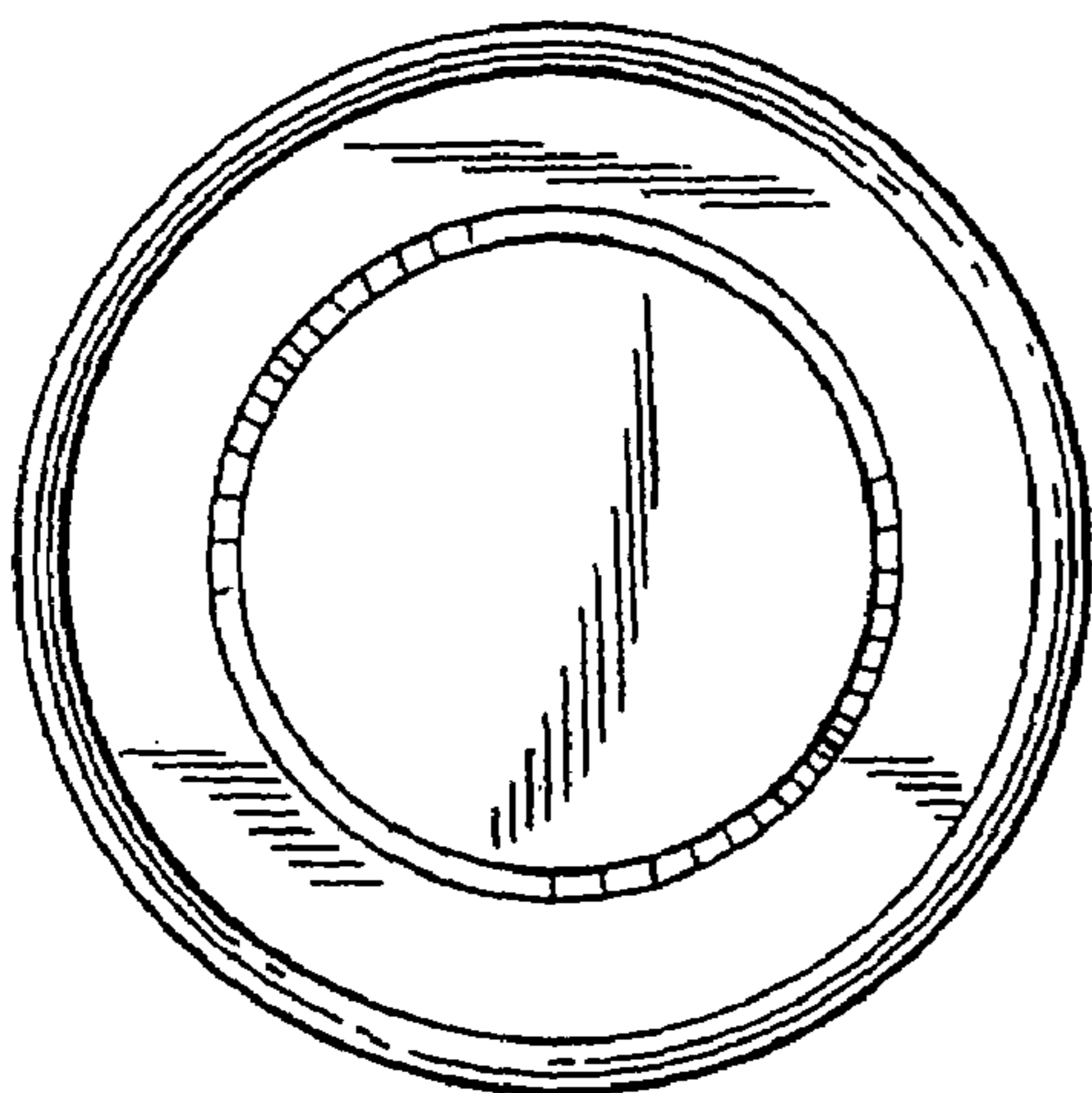
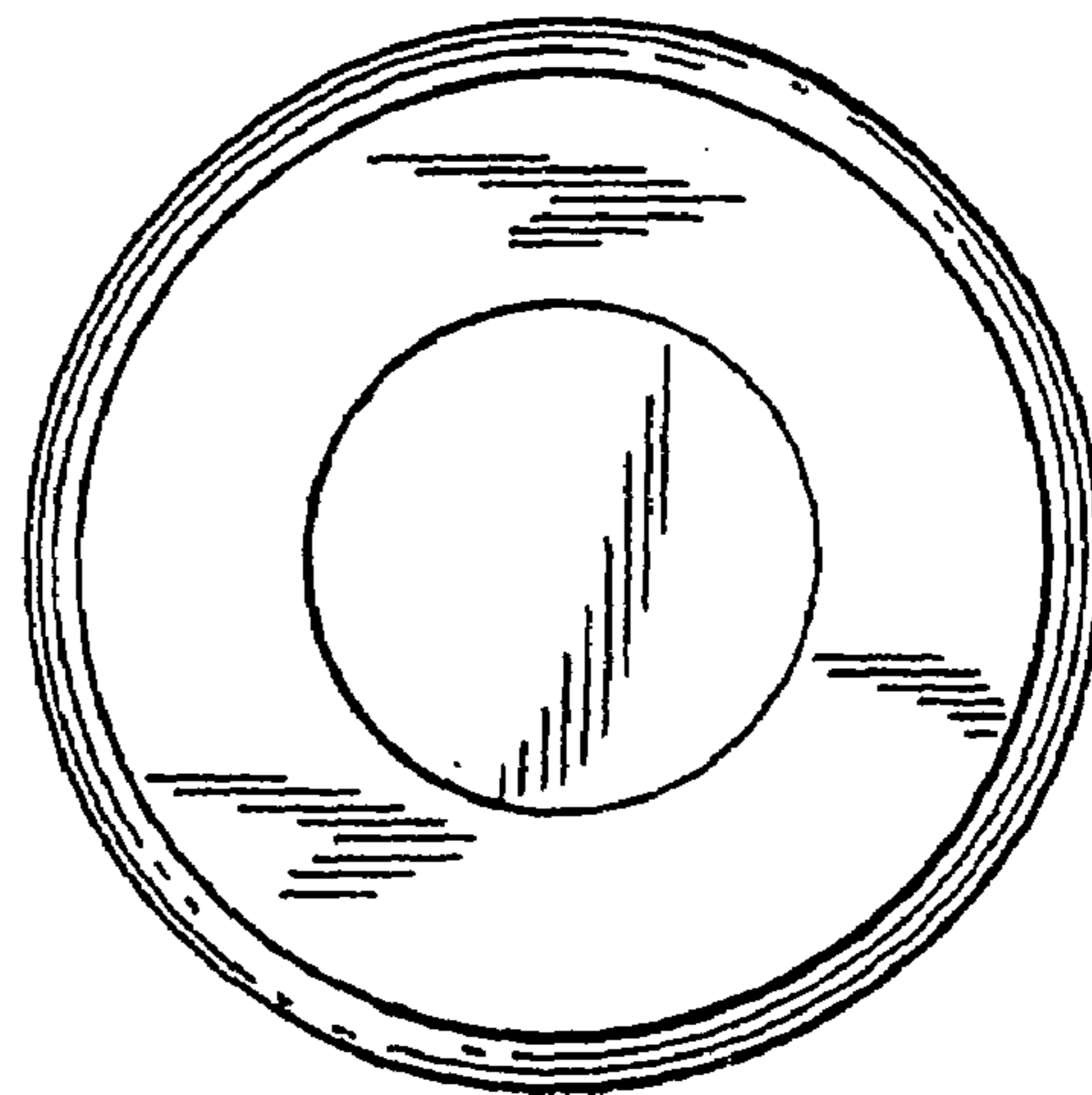

FIG. 10





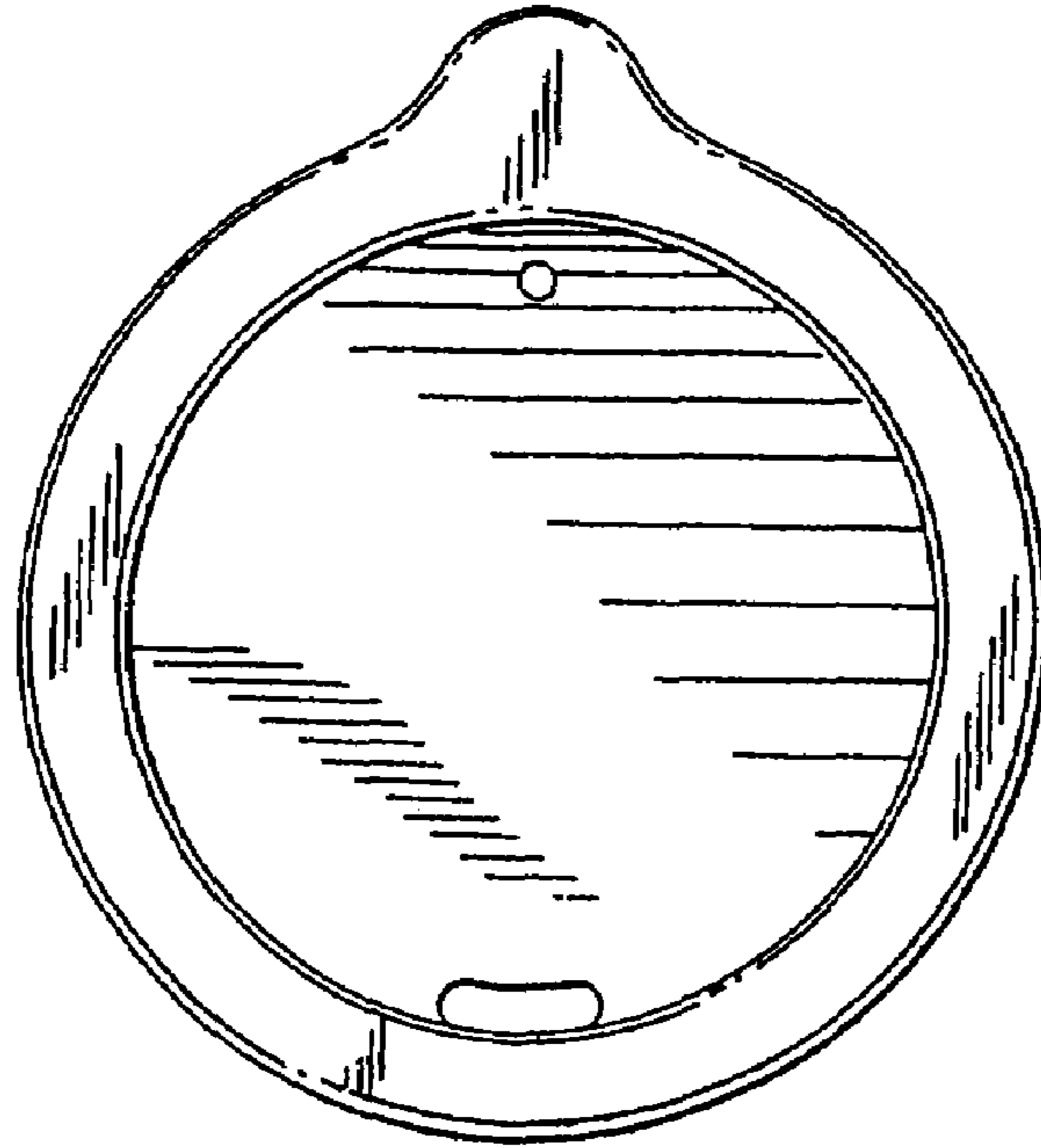

FIG. 11

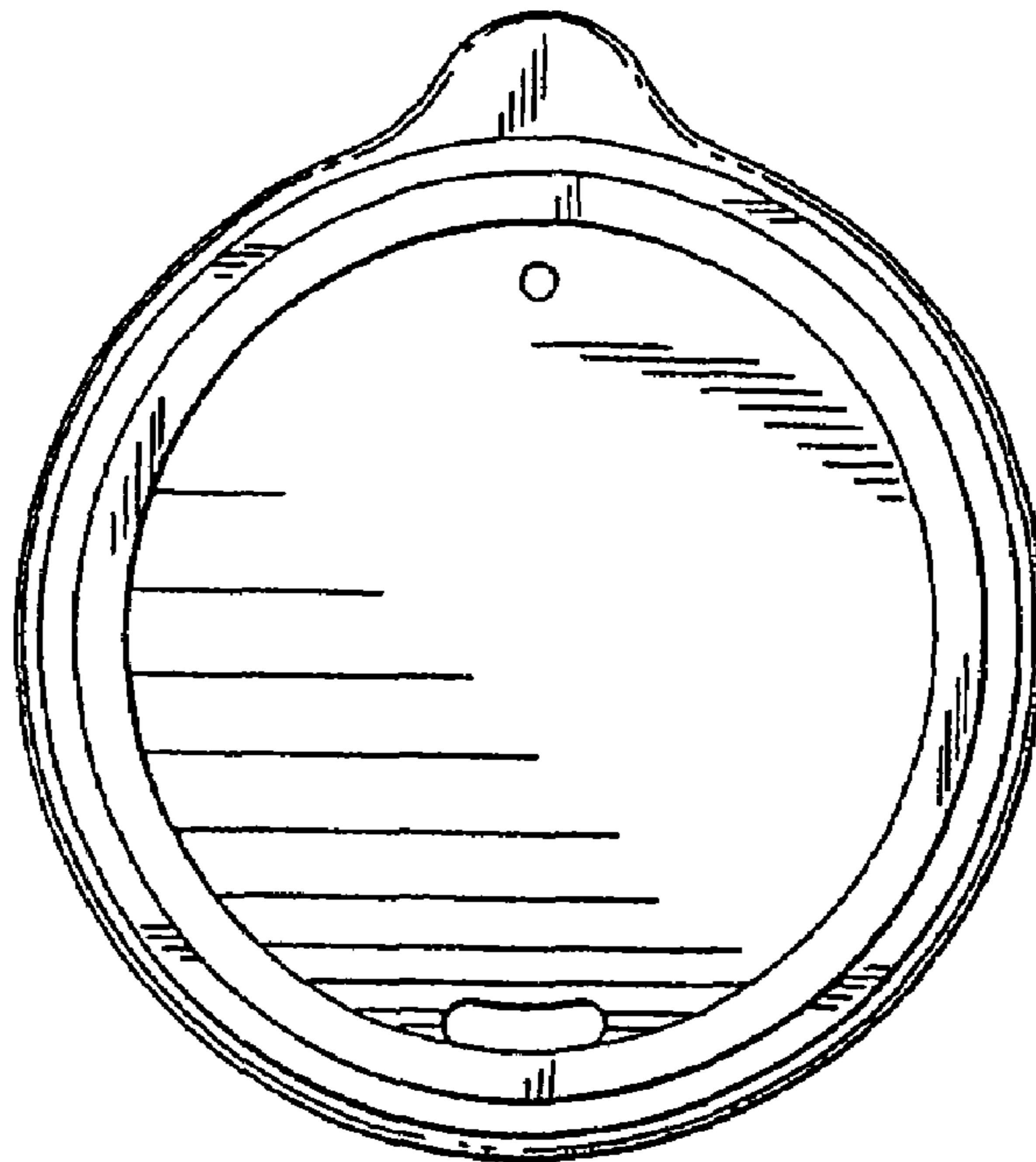

FIG. 12

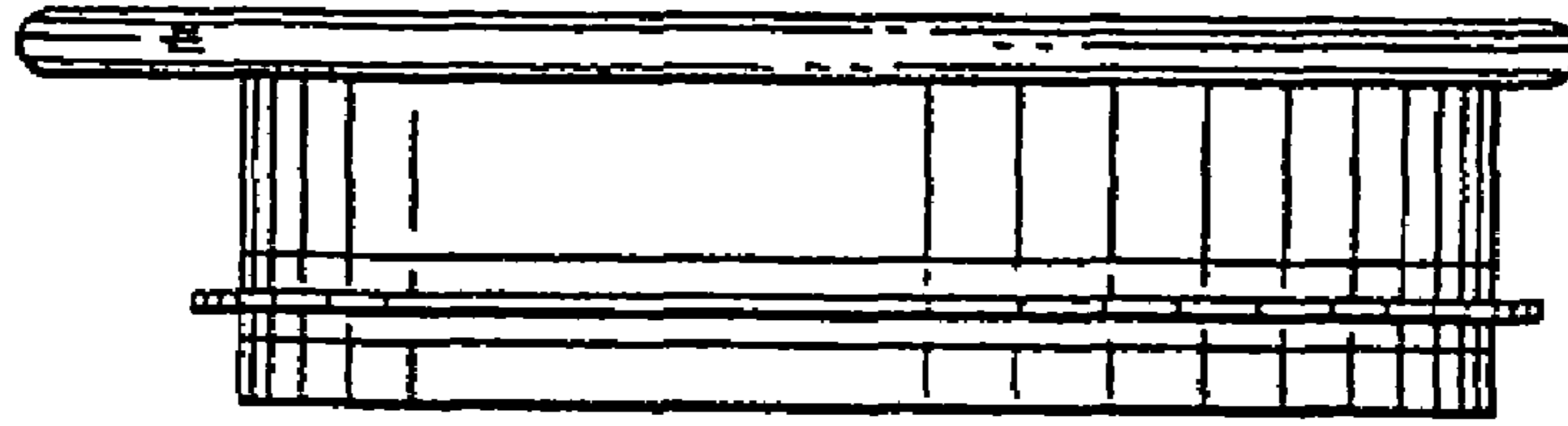

FIG. 13

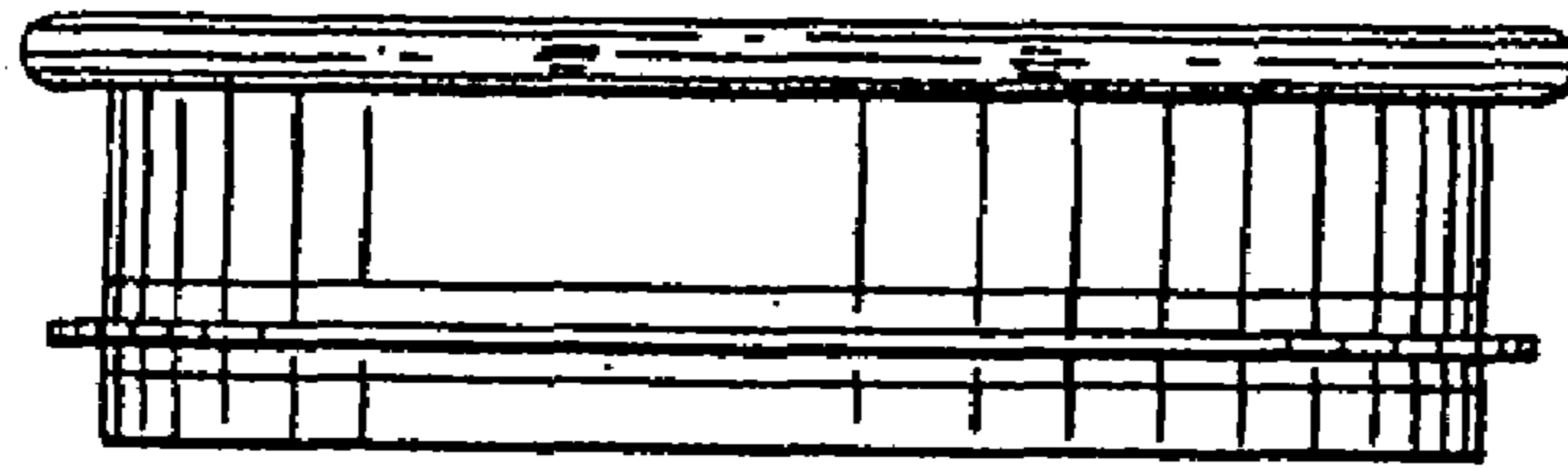

FIG. 14

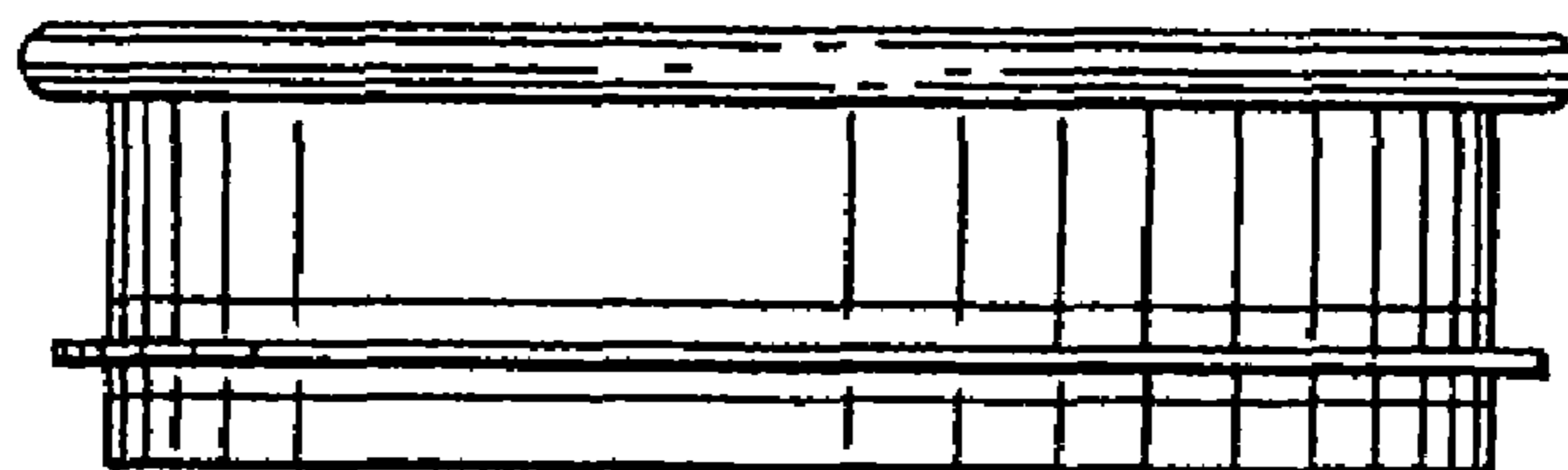

FIG. 15

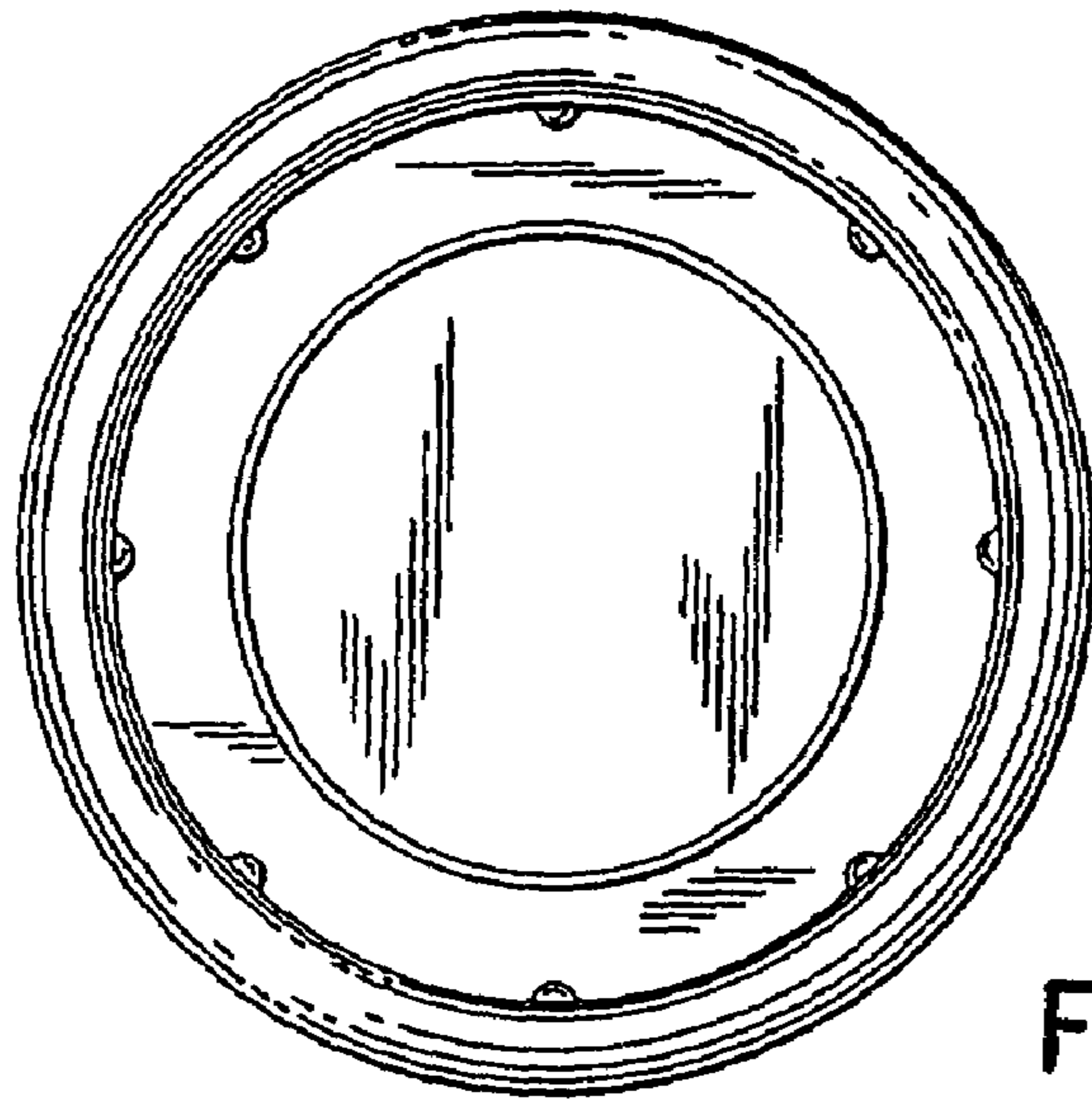

FIG. 16

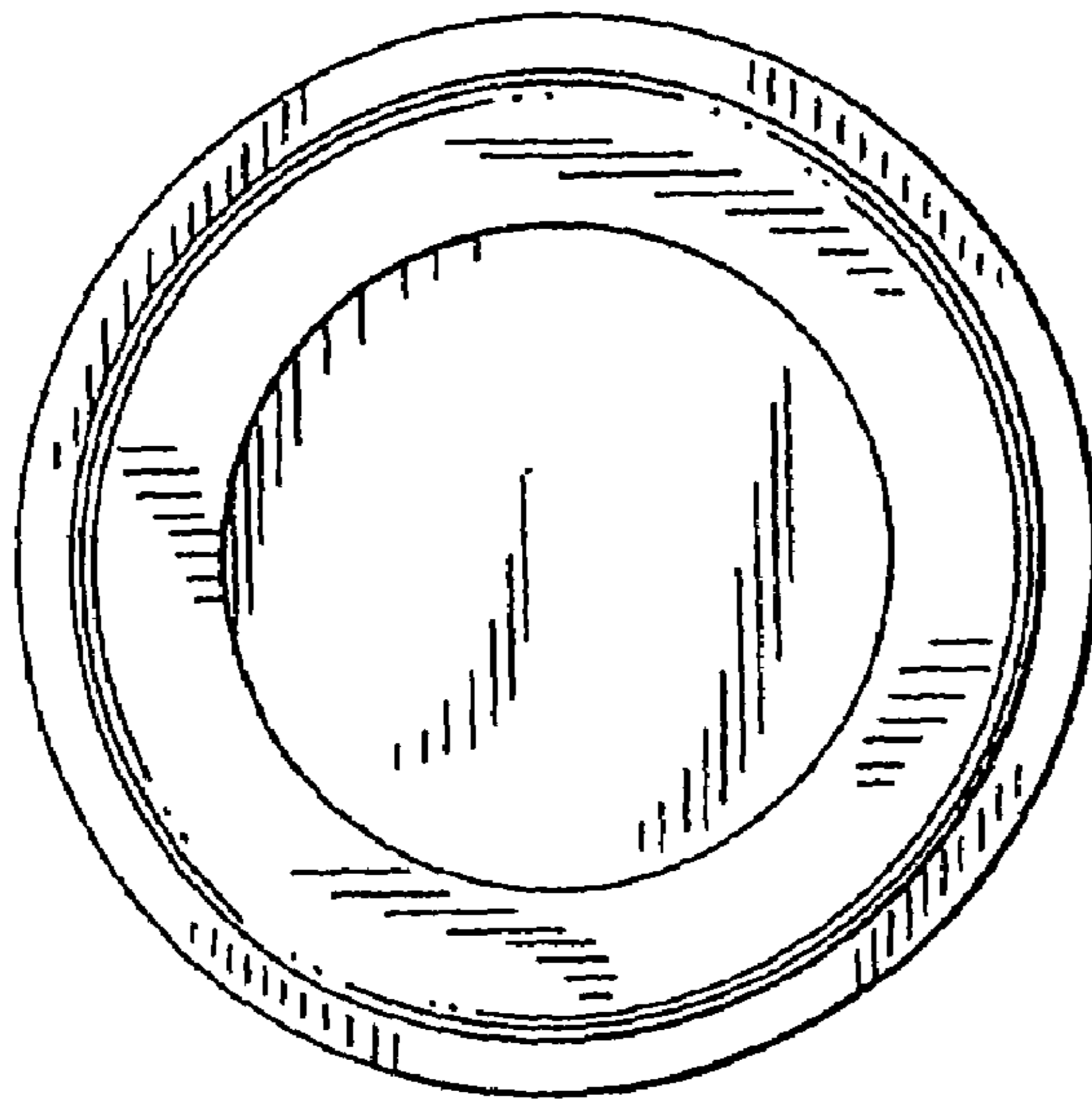

FIG. 17

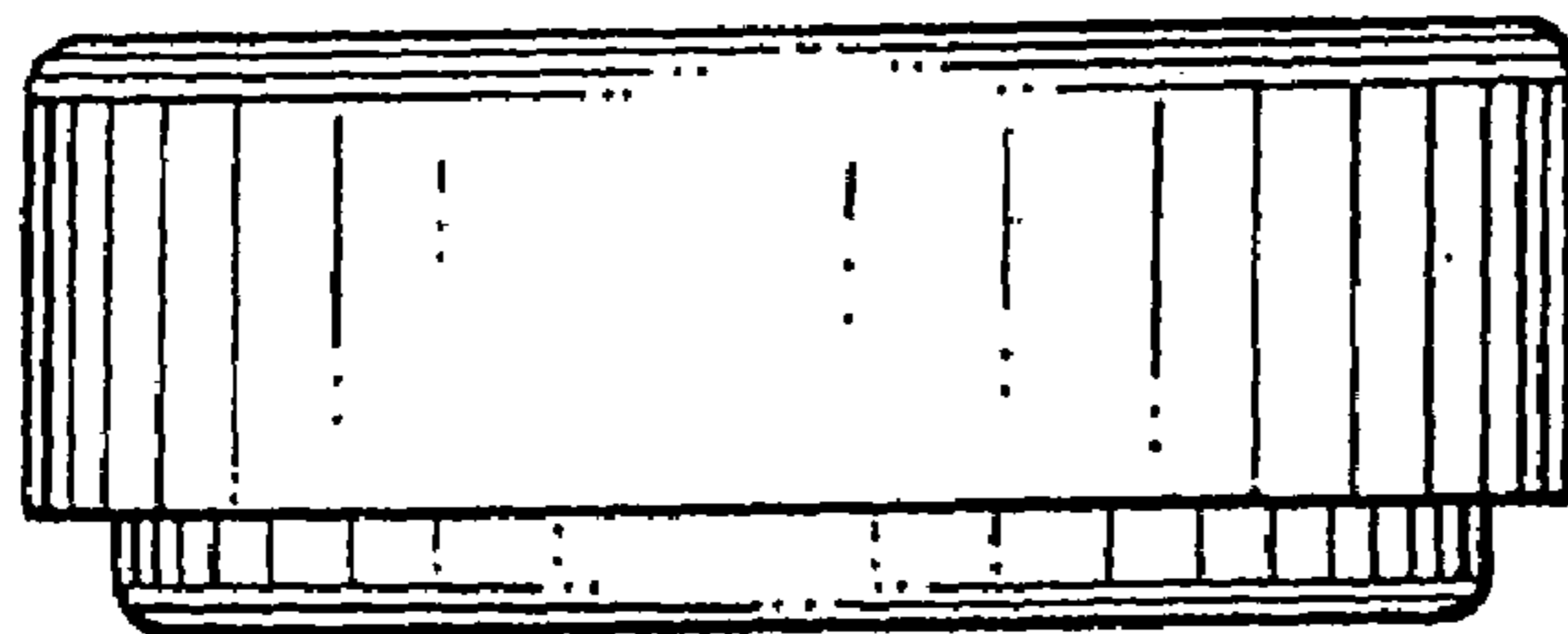

FIG. 18