



US00D553876S

(12) **United States Design Patent**
Walker

(10) **Patent No.:** **US D553,876 S**

(45) **Date of Patent:** **** Oct. 30, 2007**

(54) **CABINET**

(75) **Inventor:** **David Lamont Walker**, Chester, PA
(US)

(73) **Assignee:** **Zenith Products Corp.**, New Castle,
DE (US)

(**) **Term:** **14 Years**

(21) **Appl. No.:** **29/247,255**

(22) **Filed:** **Jun. 8, 2006**

(51) **LOC (8) Cl.** **06-04**

(52) **U.S. Cl.** **D6/432; D6/448**

(58) **Field of Classification Search** D6/408,
D6/432-448, 520, 523, 551; 312/34.2, 34.22,
312/114, 138.1, 204, 224; 206/389, 391,
206/804

See application file for complete search history.

(56) **References Cited**

U.S. PATENT DOCUMENTS

- D374,571 S * 10/1996 Paus D6/445
- D434,581 S * 12/2000 Spann, Jr. D6/445
- D488,323 S * 4/2004 Clucas D6/438
- D501,100 S * 1/2005 Walker D6/448

- D501,101 S * 1/2005 Harwanko D6/448
- D508,793 S * 8/2005 Walker D6/408
- D509,679 S * 9/2005 Katz et al. D6/436
- D522,269 S * 6/2006 Walker D6/432

* cited by examiner

Primary Examiner—Mimosa De

(74) *Attorney, Agent, or Firm*—Akin Gump Strauss Hauer &
Feld LLP

(57) **CLAIM**

The ornamental design for a cabinet, as shown and described.

DESCRIPTION

FIG. 1 is a front perspective view of a cabinet in accordance with my new design;

FIG. 2 is a front elevational view thereof;

FIG. 3 is a rear elevational view thereof;

FIG. 4 is a left side elevational view thereof;

FIG. 5 is a right side elevational view thereof;

FIG. 6 is a top plan view thereof; and,

FIG. 7 is a bottom plan view thereof.

1 Claim, 4 Drawing Sheets

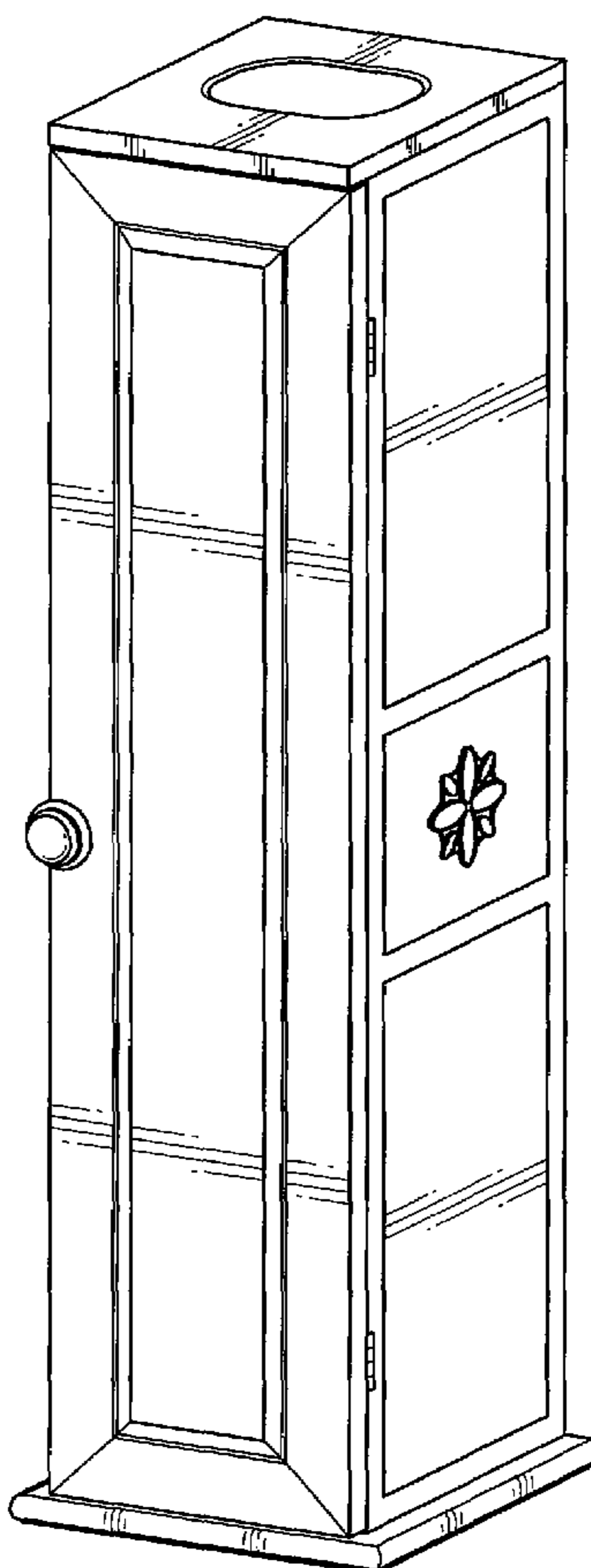



FIG. 1

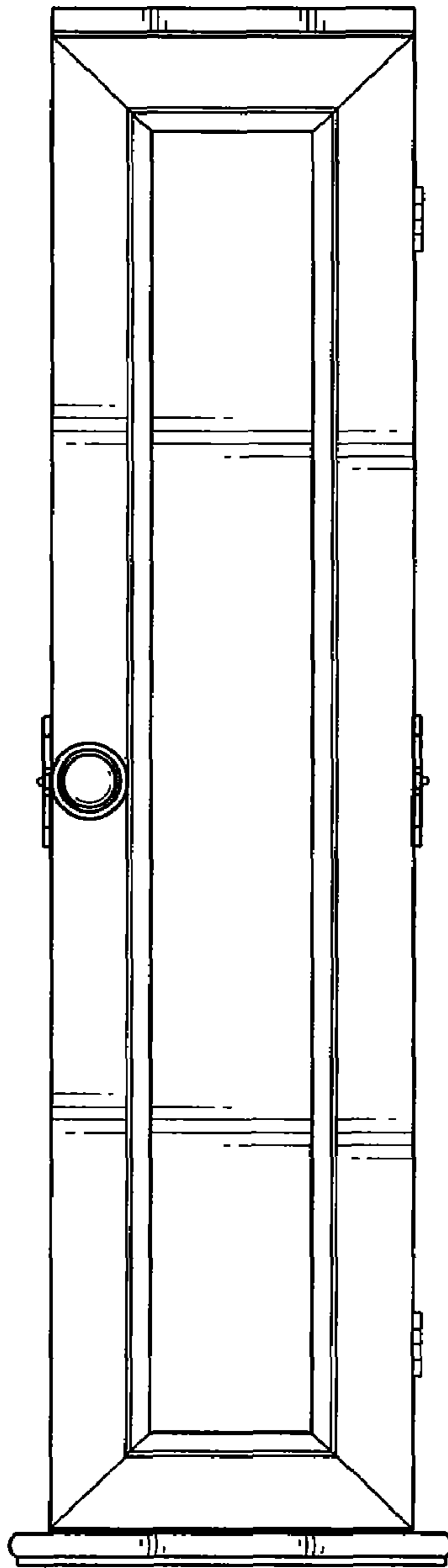

FIG. 2

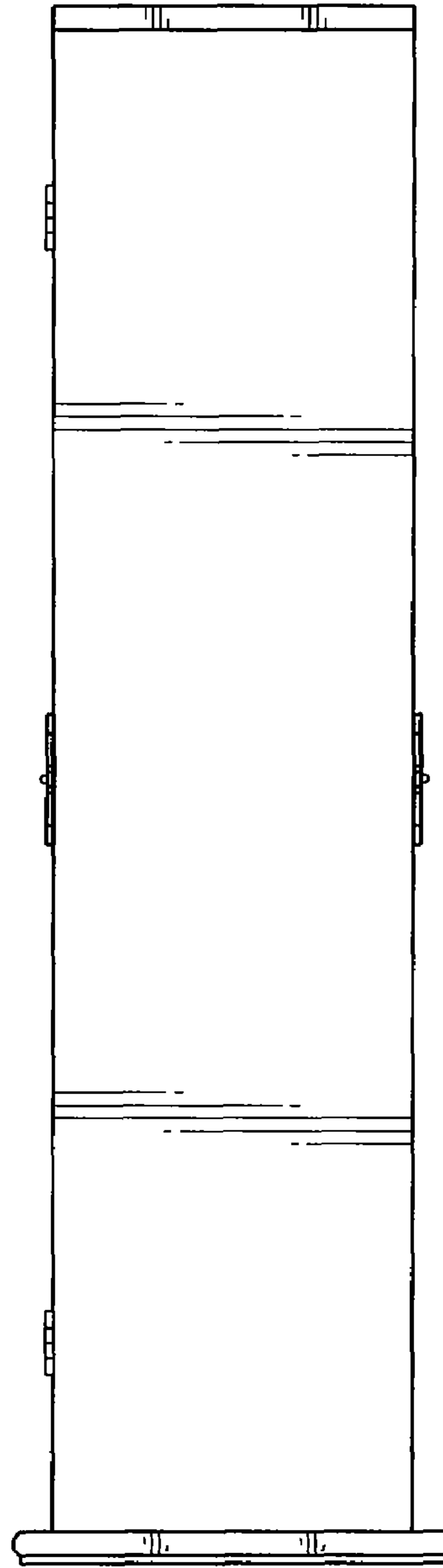

FIG. 3

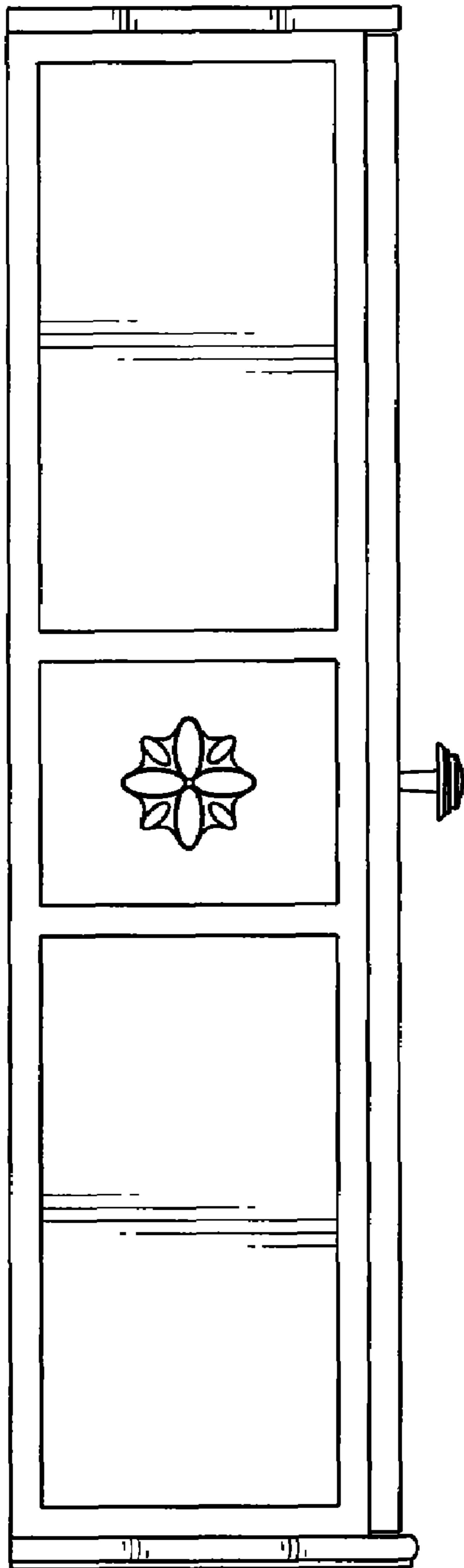

FIG. 4

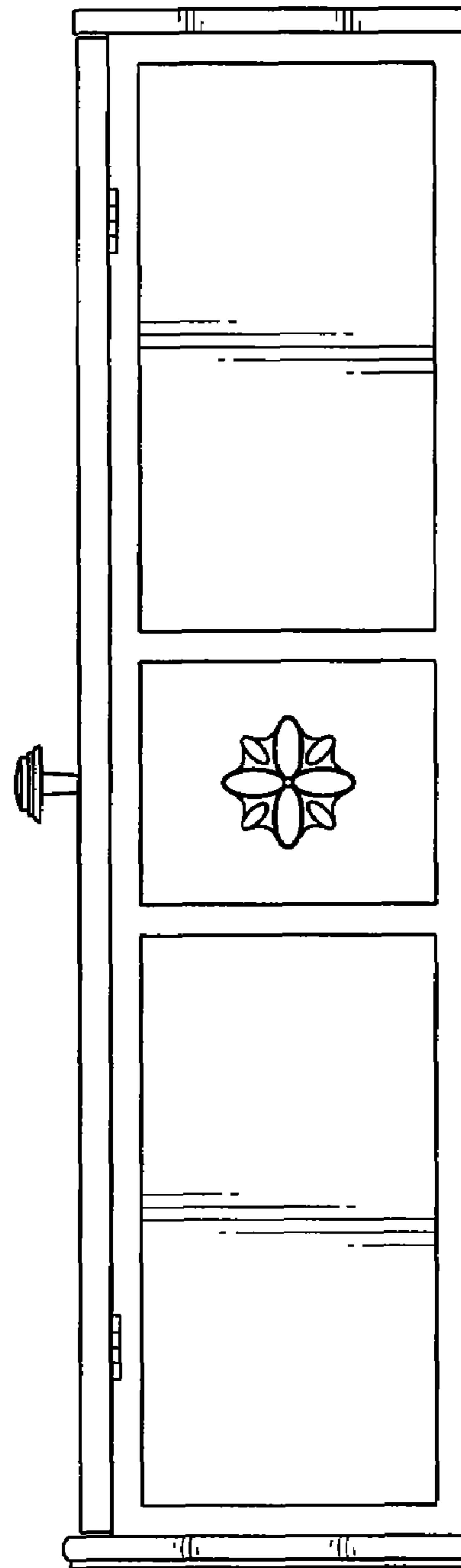

FIG. 5

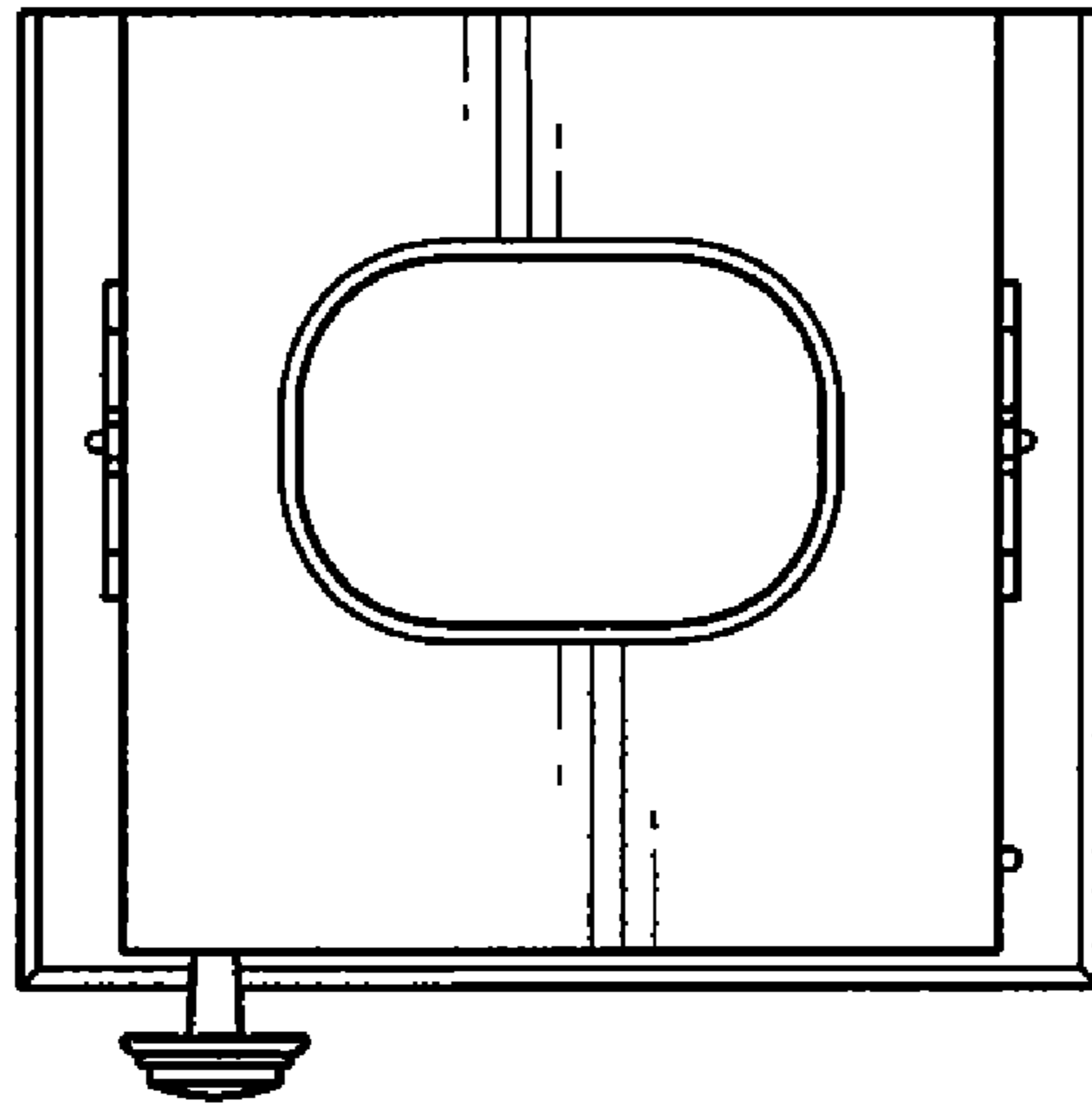

FIG. 6

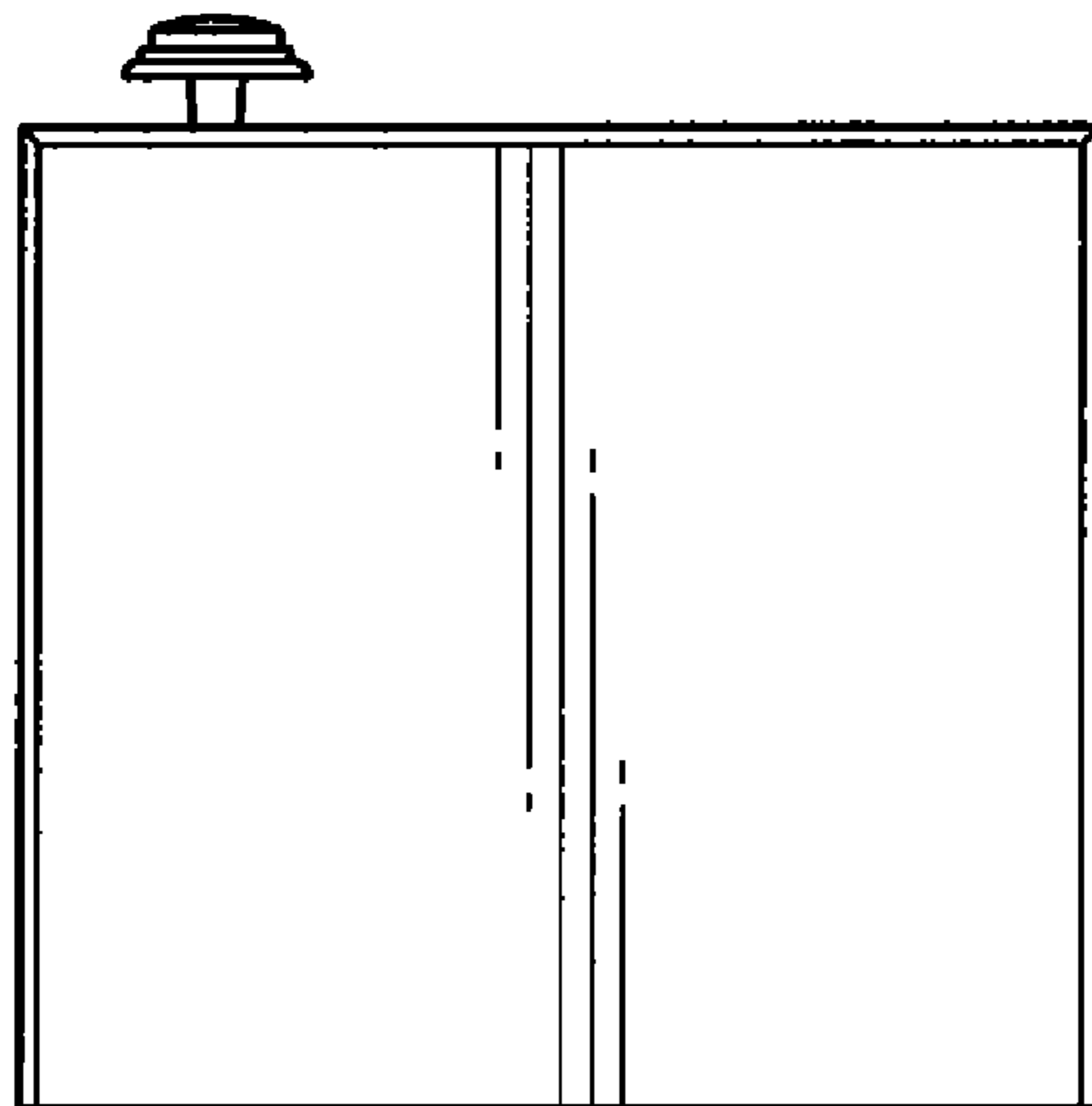

FIG. 7