



US00D553804S

(12) **United States Design Patent**
Kaposi

(10) **Patent No.:** **US D553,804 S**

(45) **Date of Patent:** **** Oct. 23, 2007**

(54) **FINGER GUARD**

(75) Inventor: **Sascha Kaposi**, Tacoma, WA (US)

(73) Assignee: **Progressive International Corporation**, Kent, WA (US)

(**) Term: **14 Years**

(21) Appl. No.: **29/247,310**

(22) Filed: **Jun. 9, 2006**

(51) **LOC (8) Cl.** **02-06**

(52) **U.S. Cl.** **D29/114; D11/26**

(58) **Field of Classification Search** D11/26-39;
63/15, 15.1-15.4, 15.45, 15.5, 15.6, 15.65,
63/15.7, 15.8, 26, 27; D29/113, 114; D7/695,
D7/387, 393, 394, 402, 405, 406; 2/21, 16,
2/163; 30/295, 298, 298.4, 296.1
See application file for complete search history.

(56) **References Cited**

U.S. PATENT DOCUMENTS

- D255,974 S * 7/1980 Jacoby D7/401.2
- D351,257 S * 10/1994 Roberts et al. D11/26
- D373,656 S * 9/1996 Sorrels D29/114
- D415,321 S * 10/1999 Silvey D29/114
- 6,237,148 B1 * 5/2001 Graham 2/21
- D465,306 S * 11/2002 Price D29/114
- D483,912 S * 12/2003 Prince et al. D11/26

- 6,729,510 B1 * 5/2004 Romanov 2/21
- D504,635 S * 5/2005 Jones D11/26
- D523,769 S * 6/2006 Arlanda D11/26
- D523,770 S * 6/2006 Arlanda D11/26
- D542,104 S * 5/2007 Holcomb et al. D7/695
- 2005/0150029 A1 * 7/2005 Votolato 2/16

* cited by examiner

Primary Examiner—Ian Simmons

Assistant Examiner—Melanie Levy

(74) *Attorney, Agent, or Firm*—Black Lowe & Graham, PLLC

(57) **CLAIM**

I claim the ornamental design for the finger guard, as shown.

DESCRIPTION

- FIG. 1 is a front view of the finger guard;
- FIG. 2 is a top view of the finger guard;
- FIG. 3 is a bottom view of the finger guard;
- FIG. 4 is a back view of the finger guard;
- FIG. 5 is a right side view of the finger guard;
- FIG. 6 is a left side view of the finger guard;
- FIG. 7 is a front perspective view of the finger guard; and,
- FIG. 8 is a back perspective view of the finger guard.

1 Claim, 4 Drawing Sheets

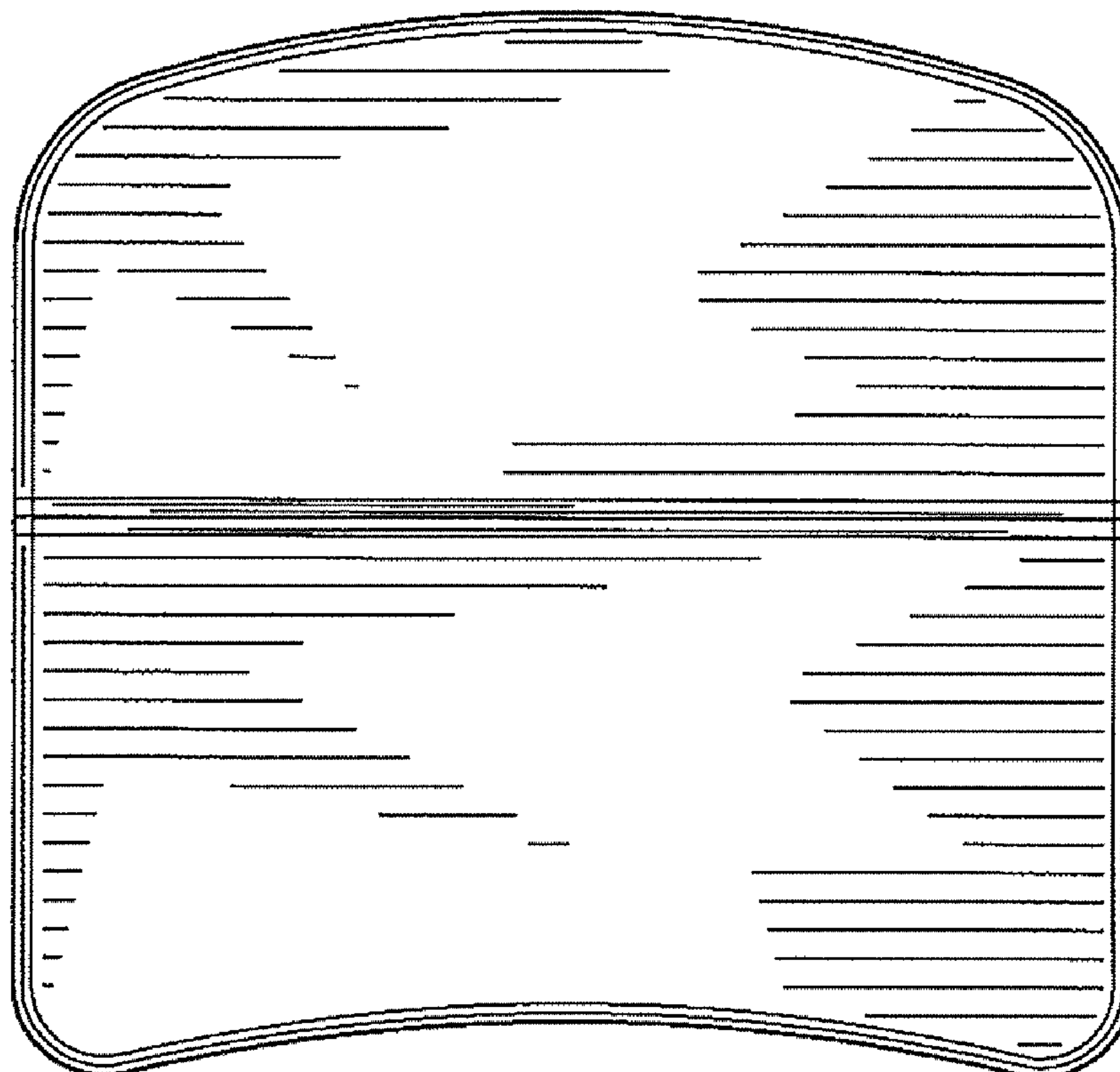

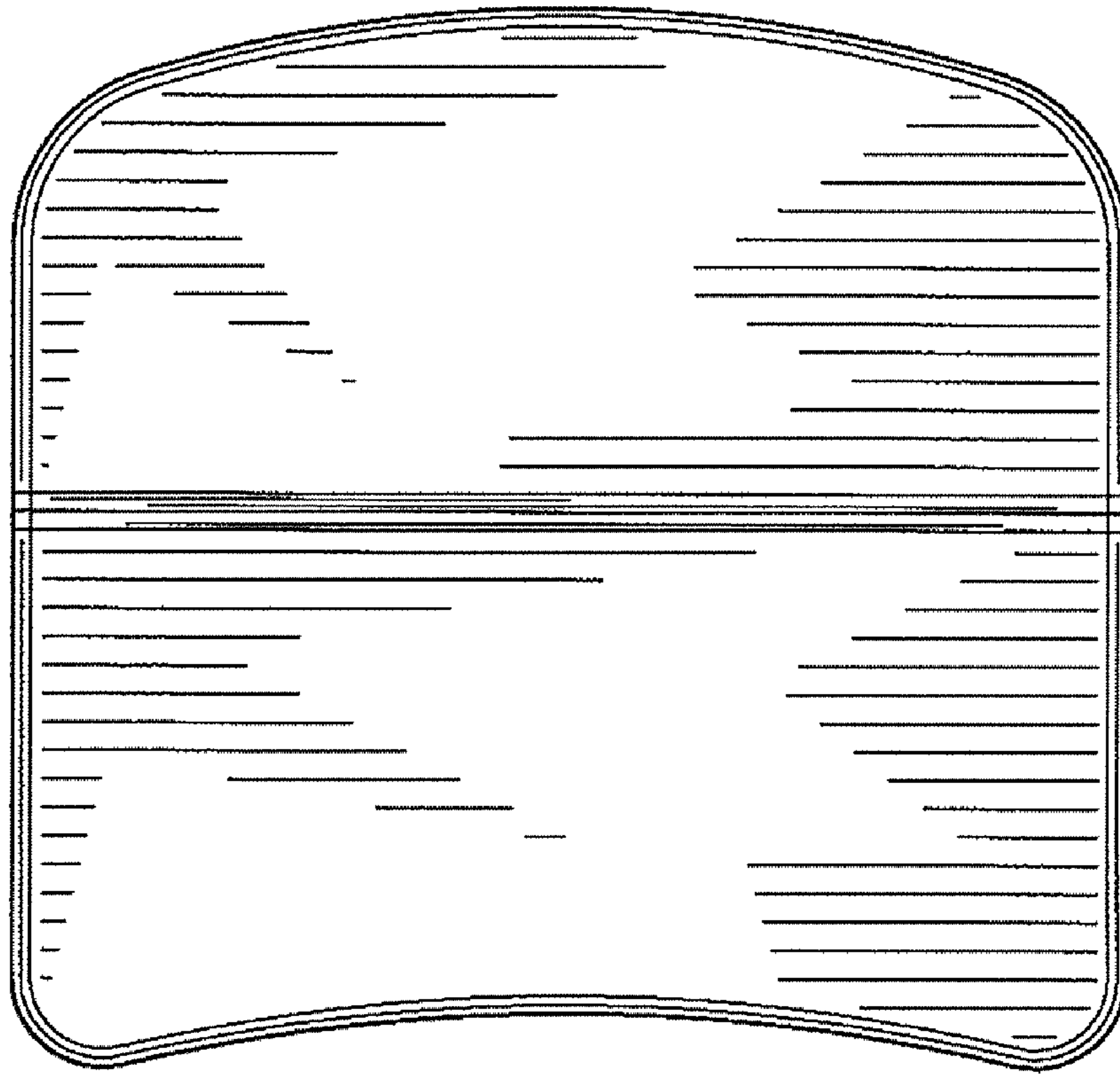

FIG. 1

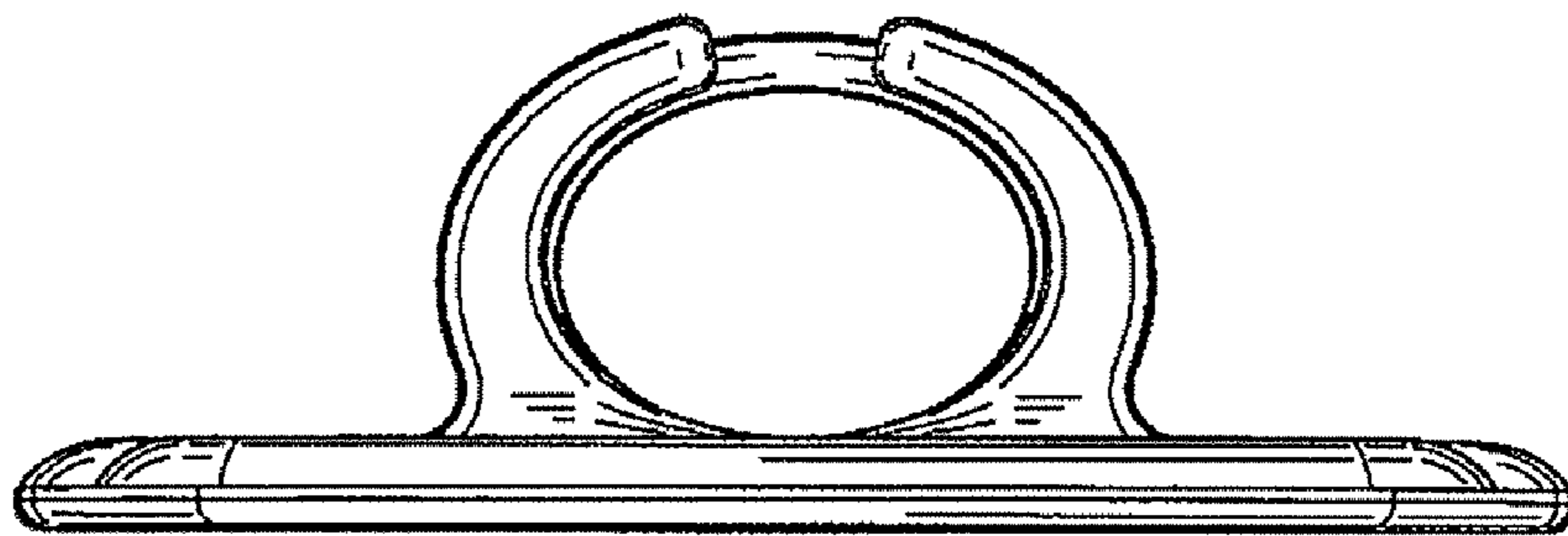

FIG. 2

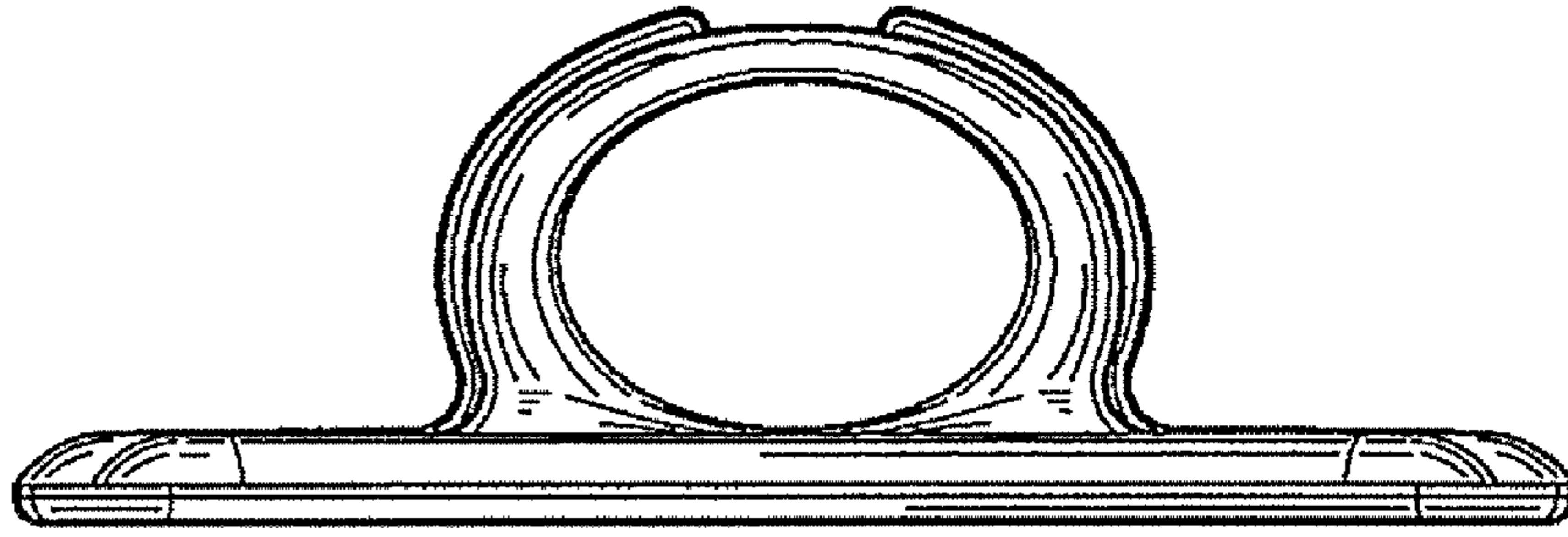

FIG. 3

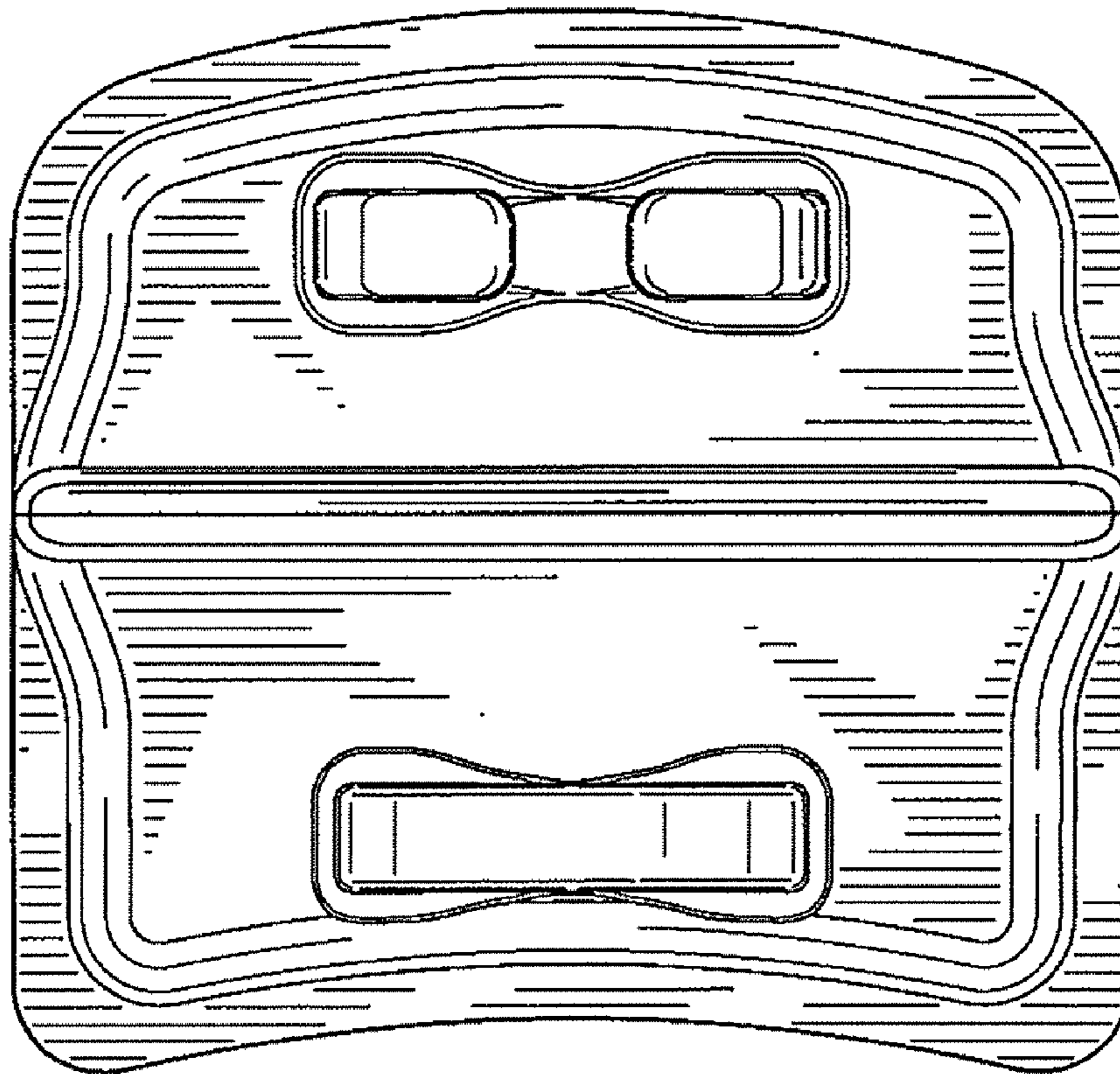

FIG. 4

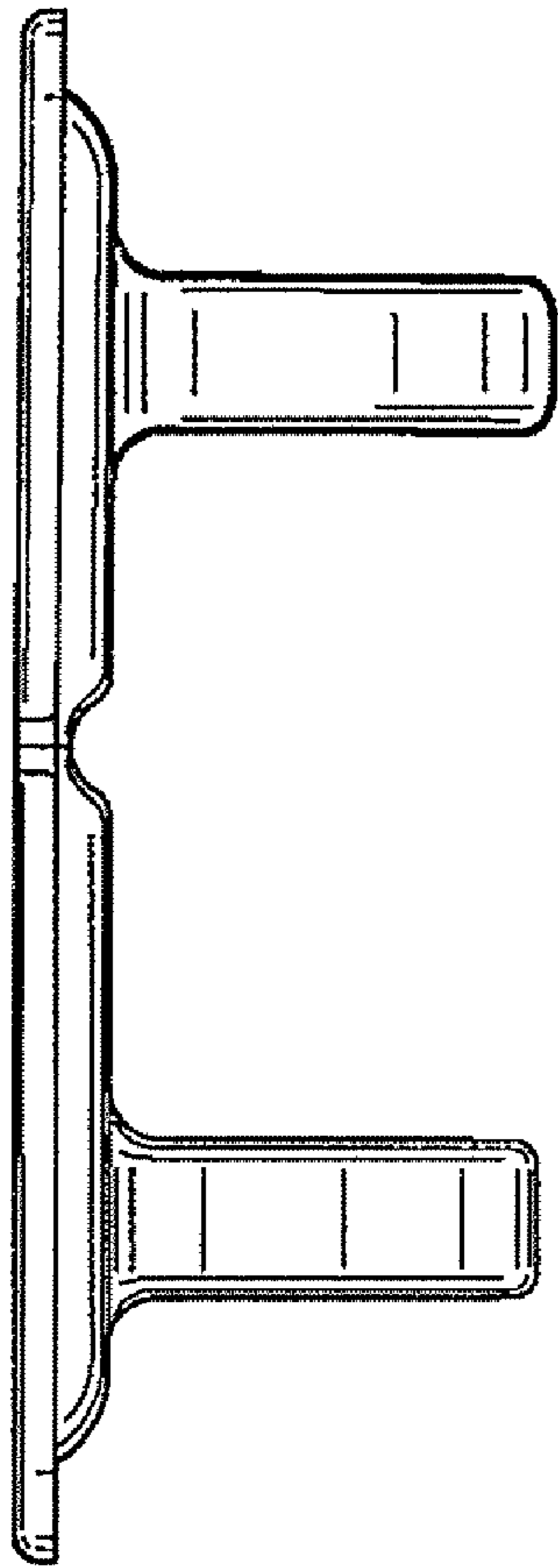

FIG. 5

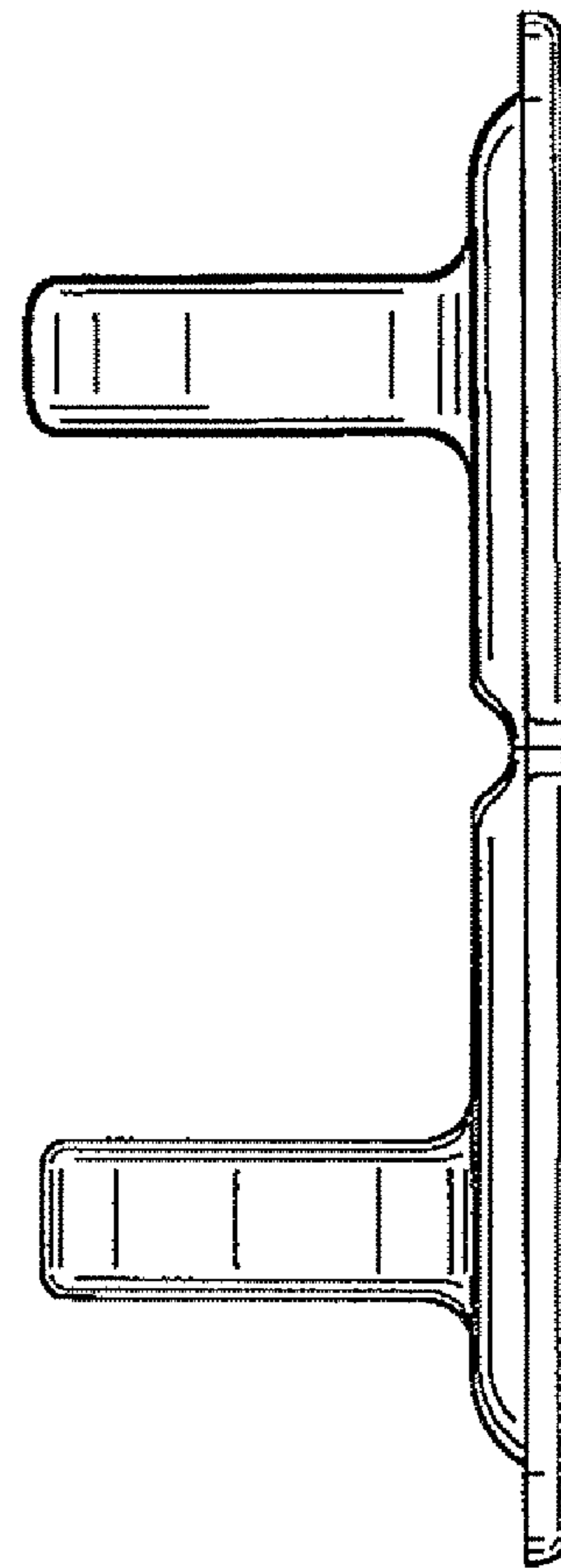

FIG. 6

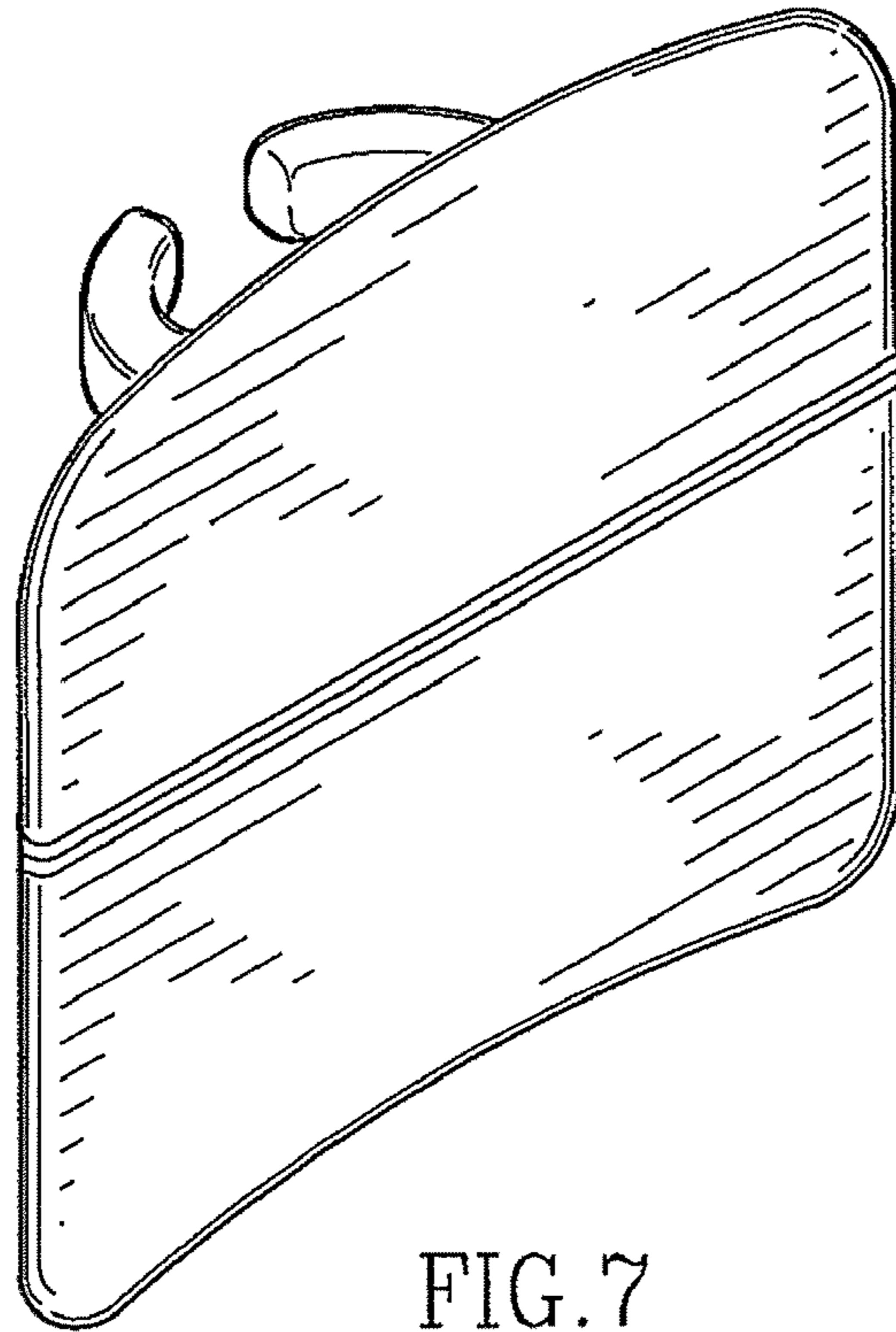

FIG. 7

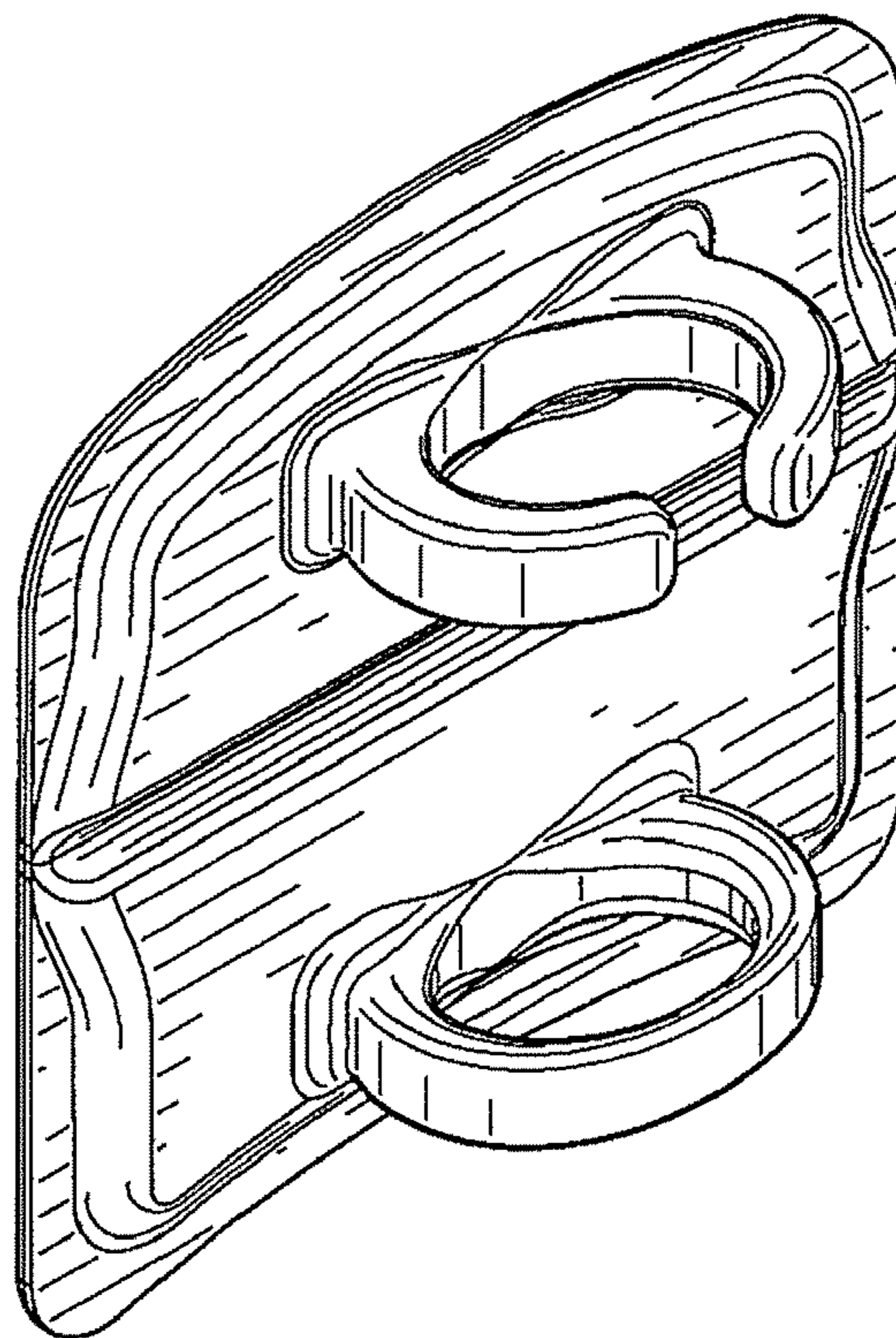

FIG. 8