



(12) **United States Design Patent**
Williams

(10) **Patent No.:** **US D553,799 S**
(45) **Date of Patent:** **** Oct. 23, 2007**

(54) **COSMETIC CASE**

(75) Inventor: **Douglas Williams**, White Plains, NY (US)

(73) Assignee: **Mana Products, Inc.**, Long Island City, NY (US)

(**) Term: **14 Years**

(21) Appl. No.: **29/266,374**

(22) Filed: **Sep. 19, 2006**

(51) **LOC (8) Cl.** **28-03**

(52) **U.S. Cl.** **D28/83**

(58) **Field of Classification Search** 132/286,
132/287, 288, 293-307, 312-318; 206/581,
206/823; D28/64.1, 64.3, 76-84

See application file for complete search history.

(56) **References Cited**

U.S. PATENT DOCUMENTS

D308,756 S *	6/1990	Turner	D3/275
5,353,947 A *	10/1994	Zinnbauer et al.	206/581
D473,681 S *	4/2003	Thorpe	D28/83
D478,688 S *	8/2003	Thorpe et al.	D28/83
2004/0206370 A1 *	10/2004	Byun	132/287

* cited by examiner

Primary Examiner—Jennifer Rivard

(74) *Attorney, Agent, or Firm*—Day Pitney LLP

(57) **CLAIM**

The ornamental design for a cosmetic case, as shown and described.

DESCRIPTION

FIG. 1 is a perspective view of the cosmetic case according to my new design;

FIG. 2 is a top elevational view of the cosmetic case;

FIG. 3 is a front elevational view thereof;

FIG. 4 is a bottom elevational view thereof;

FIG. 5 is a rear elevational view thereof;

FIG. 6 is a left-side elevational view of the cosmetic case;

FIG. 7 is a right-side elevational view thereof;

FIG. 8 is a perspective view of the cosmetic case with the upper and lower portions thereof separated from one another;

FIG. 9 is a perspective view of the upper portion of the cosmetic case in an open condition;

FIG. 10 is an elevational view of the bottom of the upper portion of the cosmetic case;

FIG. 11 is an elevational view of the front of the upper portion thereof;

FIG. 12 is an elevational view of the rear of the upper portion thereof;

FIG. 13 is an elevational view of the left side of the upper portion thereof;

FIG. 14 is an elevational view of the right side of the upper portion thereof;

FIG. 15 is a perspective view of the lower portion of the cosmetic case in an open condition;

FIG. 16 is an elevational view of the front of the lower portion of the cosmetic case;

FIG. 17 is an elevational view of the left side of the lower portion thereof;

FIG. 18 is an elevational view of the right side of the lower portion thereof;

FIG. 19 is an elevational view of the right side of the lower portion of the cosmetic case in an open condition; and,

FIG. 20 is an elevational view of the bottom of the lower portion of the cosmetic case in an open condition.

The upper and lower portions of the claimed design are disclosed separately for convenience of illustration. The broken lines are shown for illustrative purposes only and form no part of the claimed design.

1 Claim, 8 Drawing Sheets

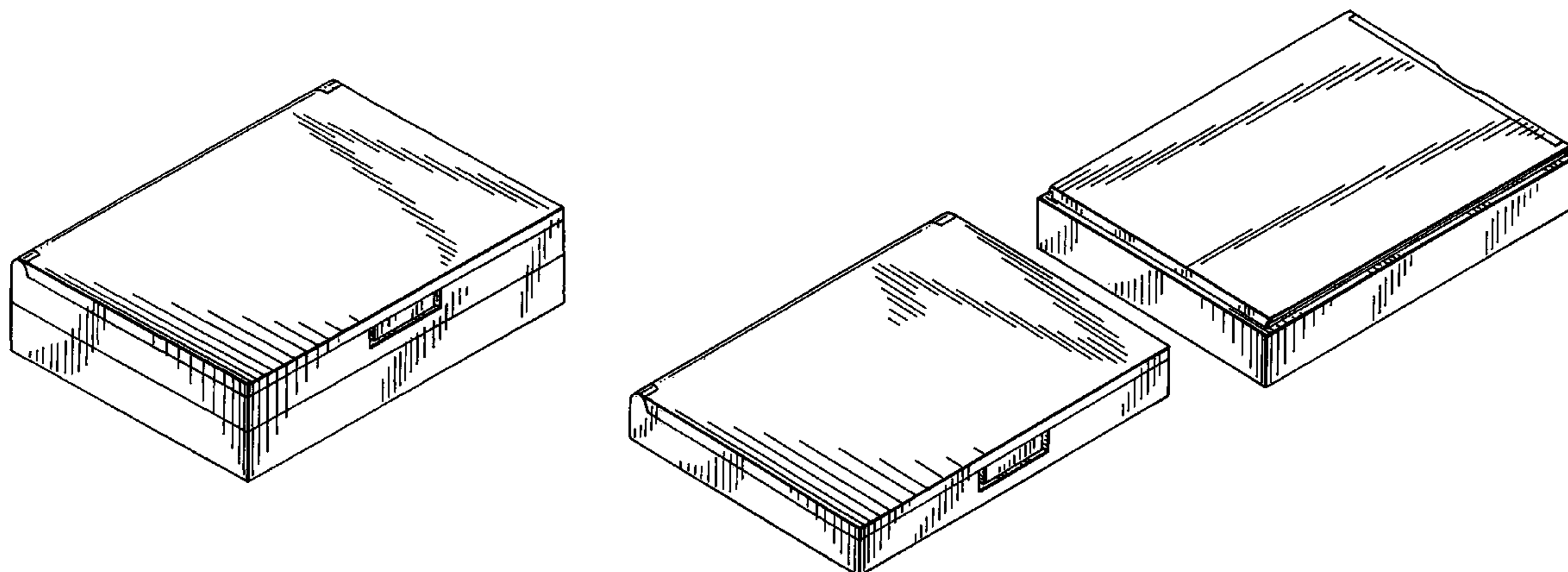

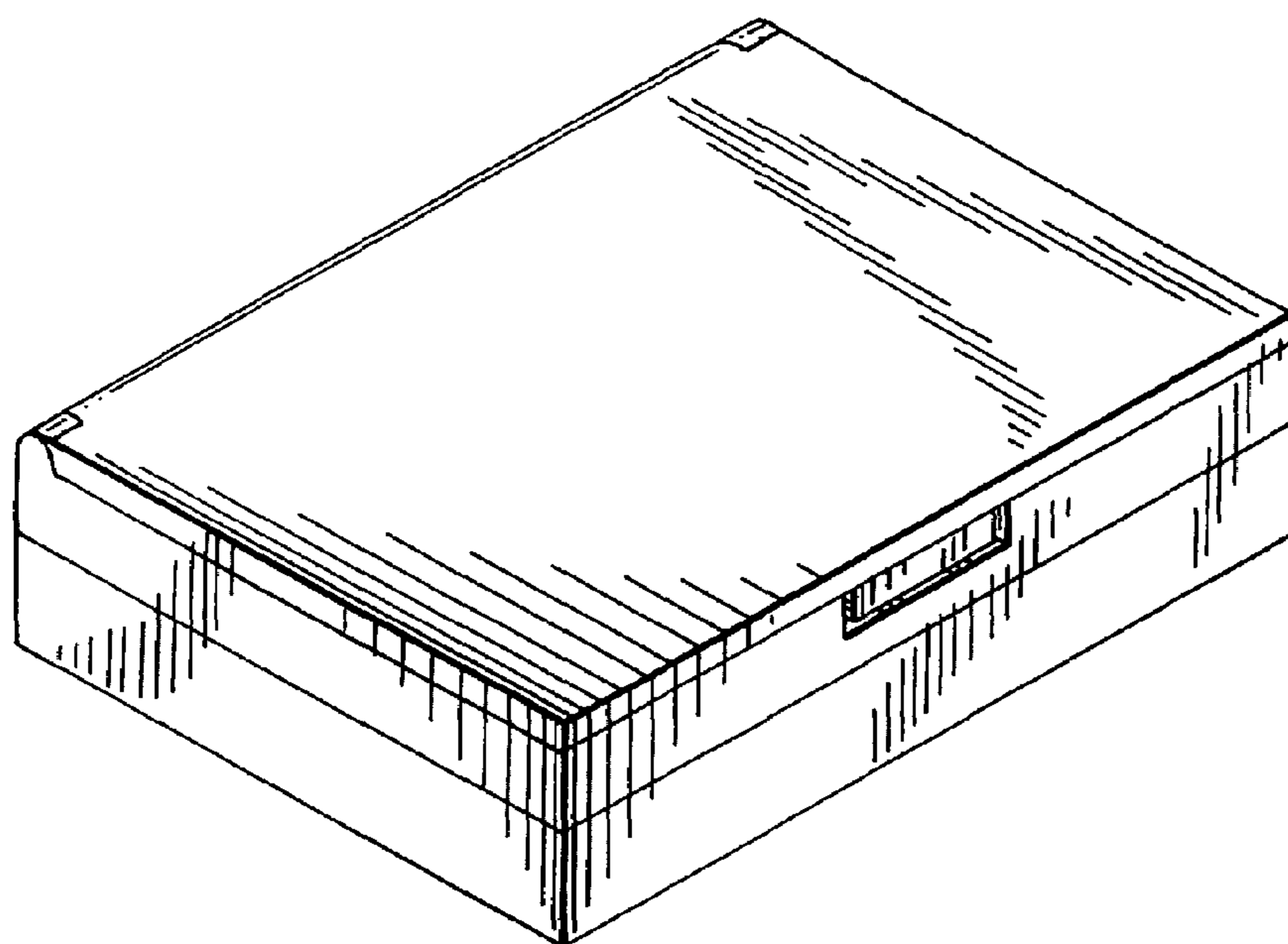

FIG. 1

FIG. 2

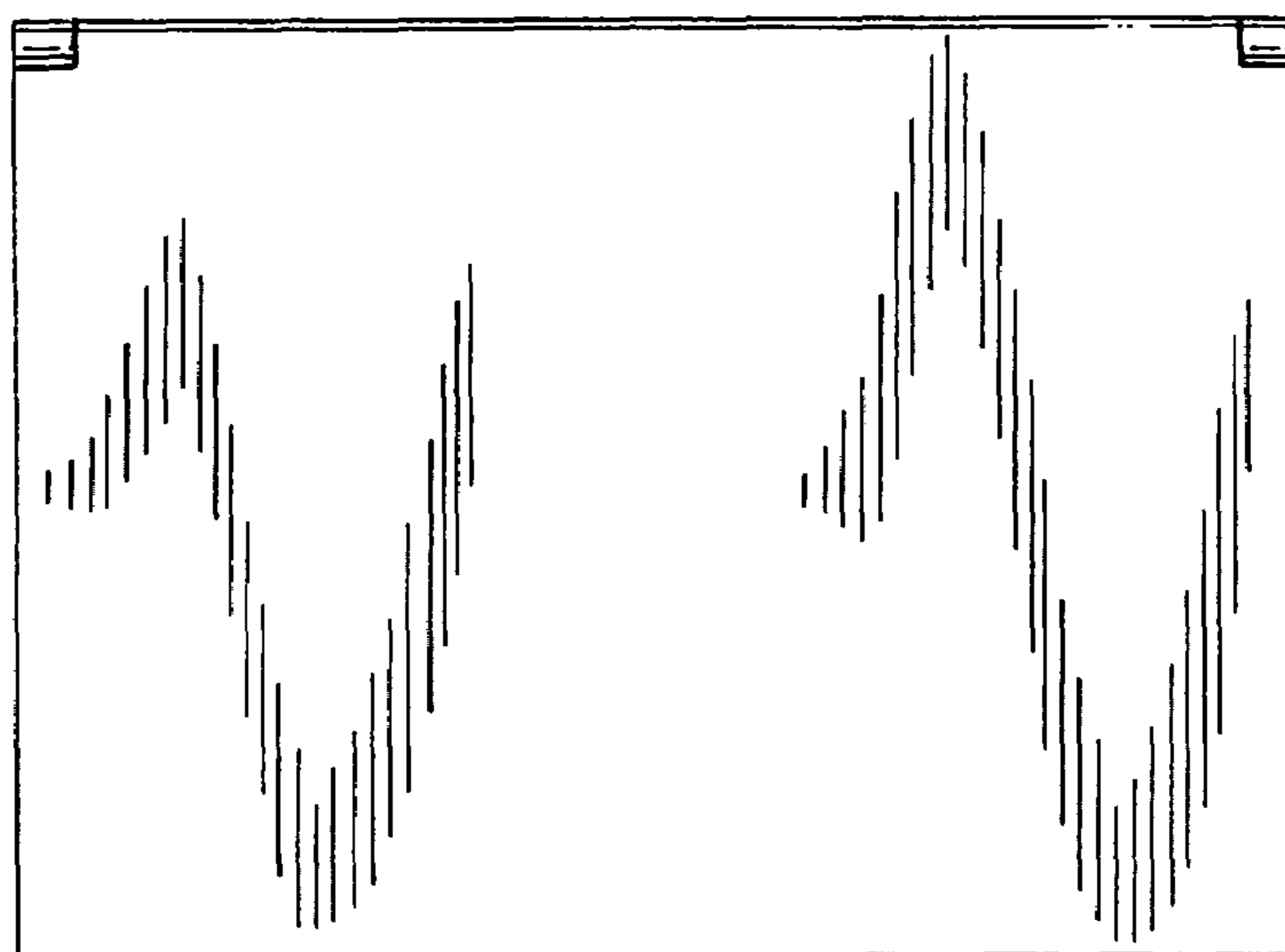

FIG. 3

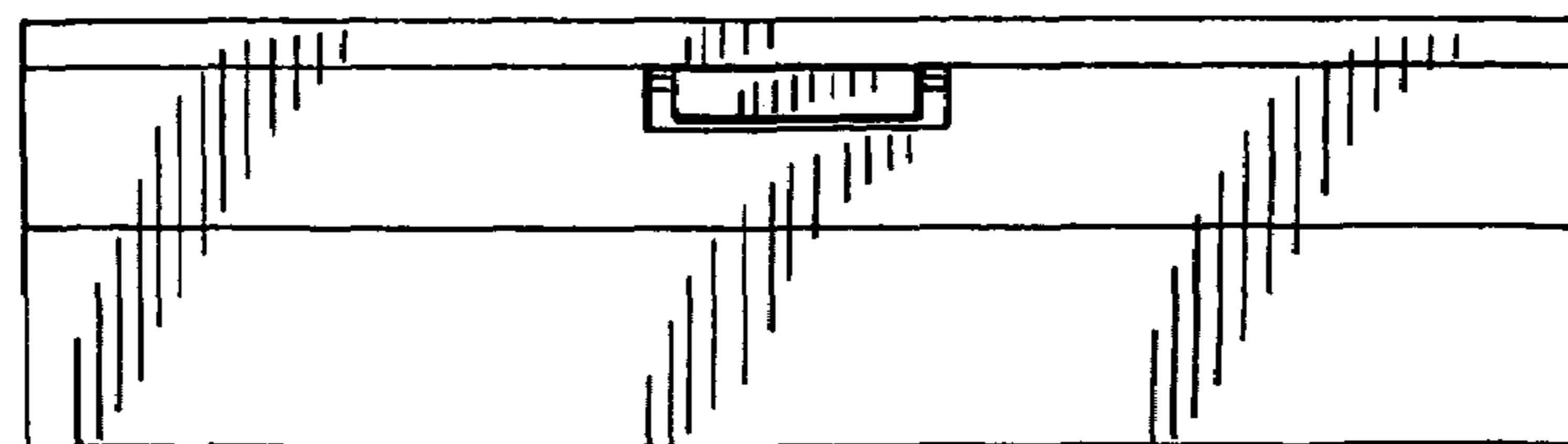

FIG. 5

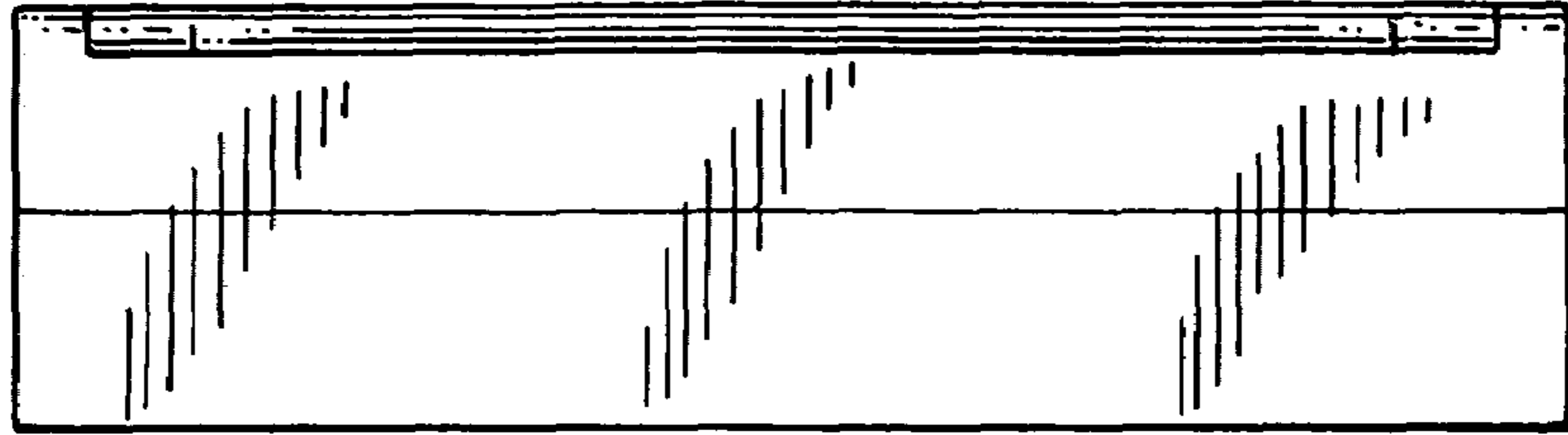

FIG. 4

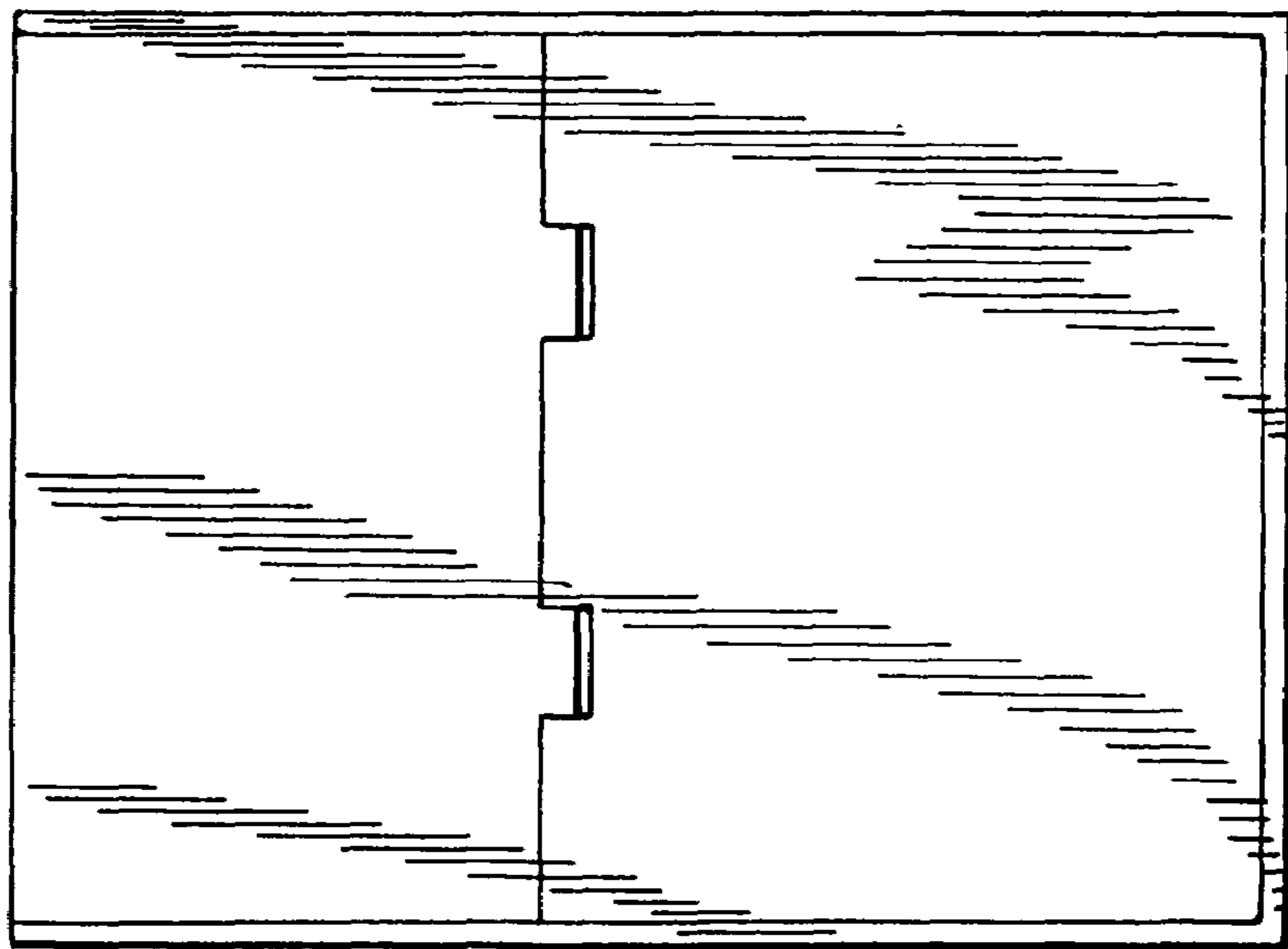

FIG. 6

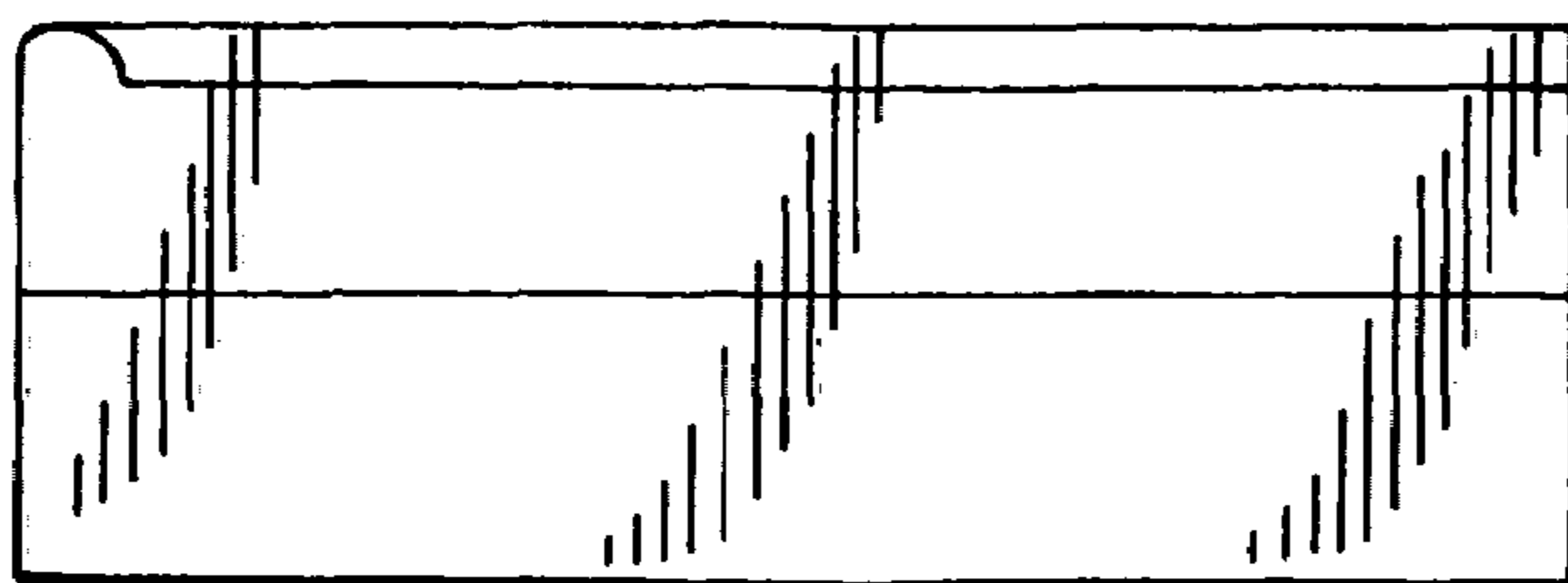

FIG. 7

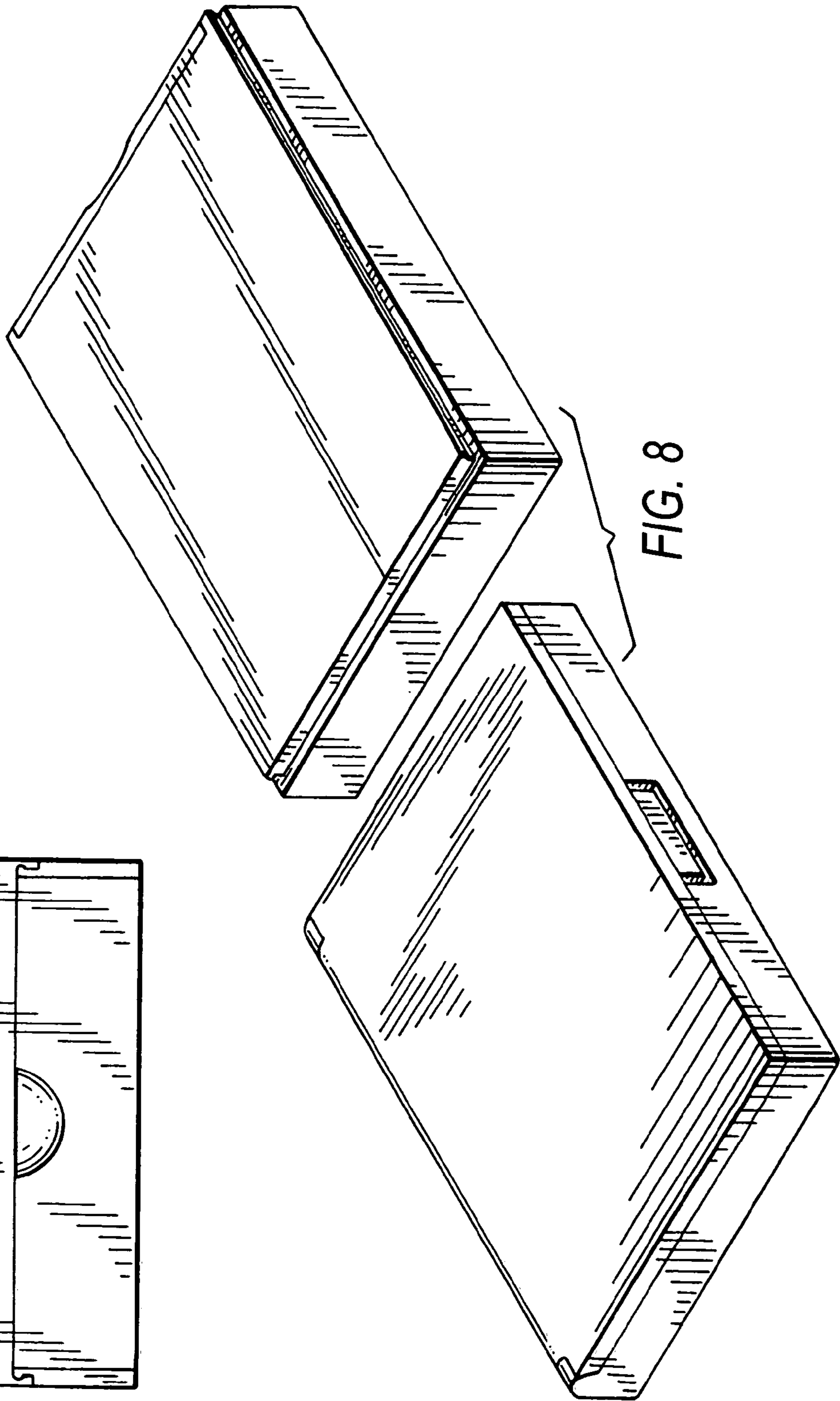
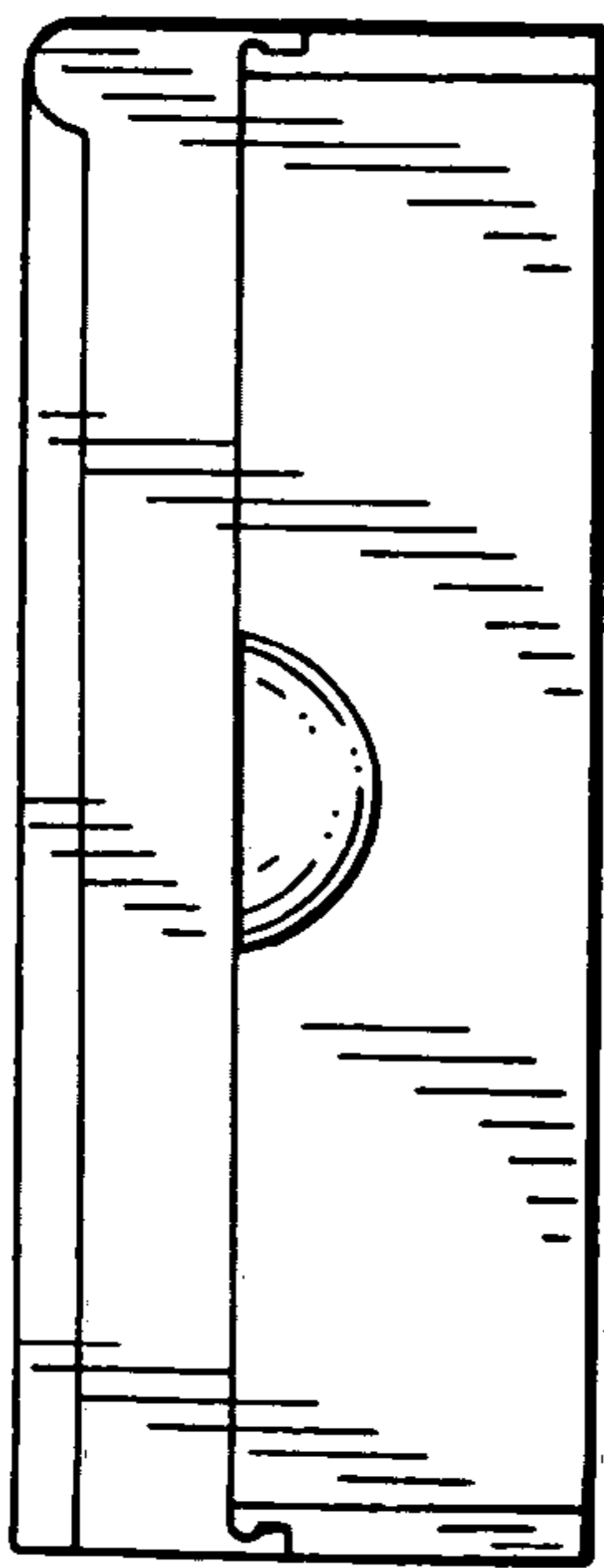

FIG. 8

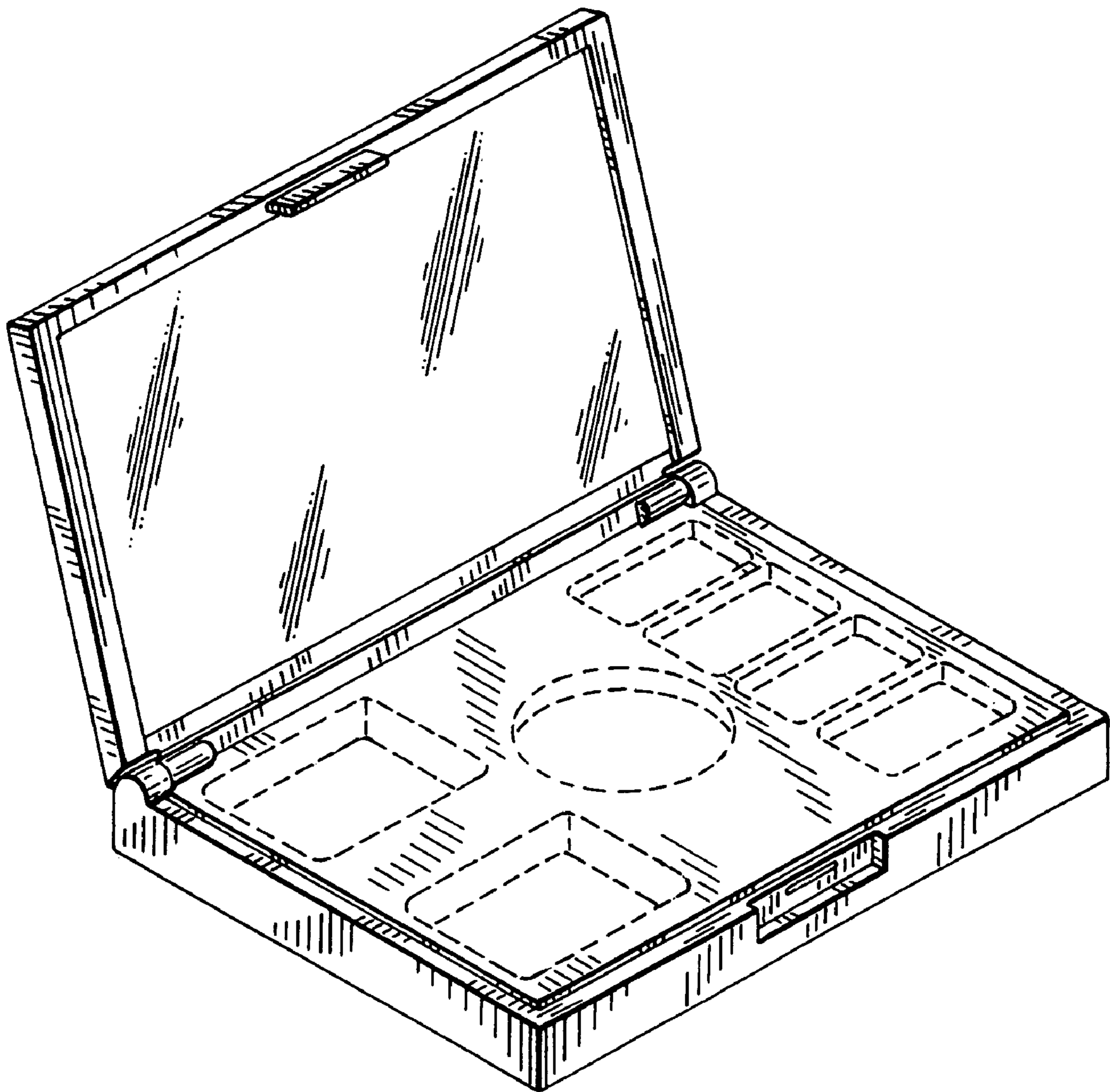

FIG. 9

FIG. 11

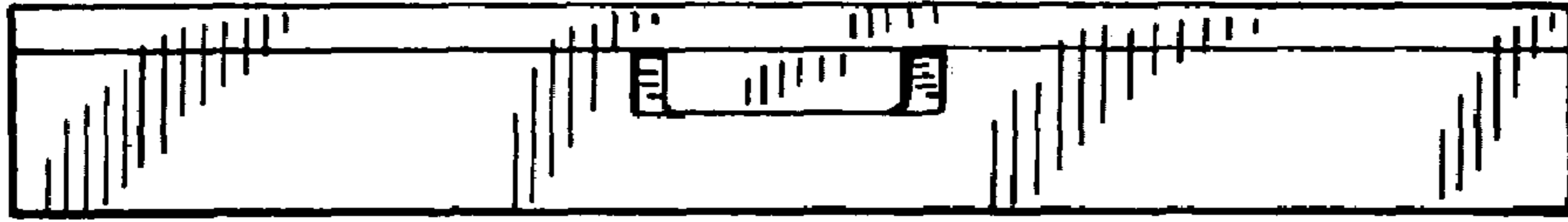
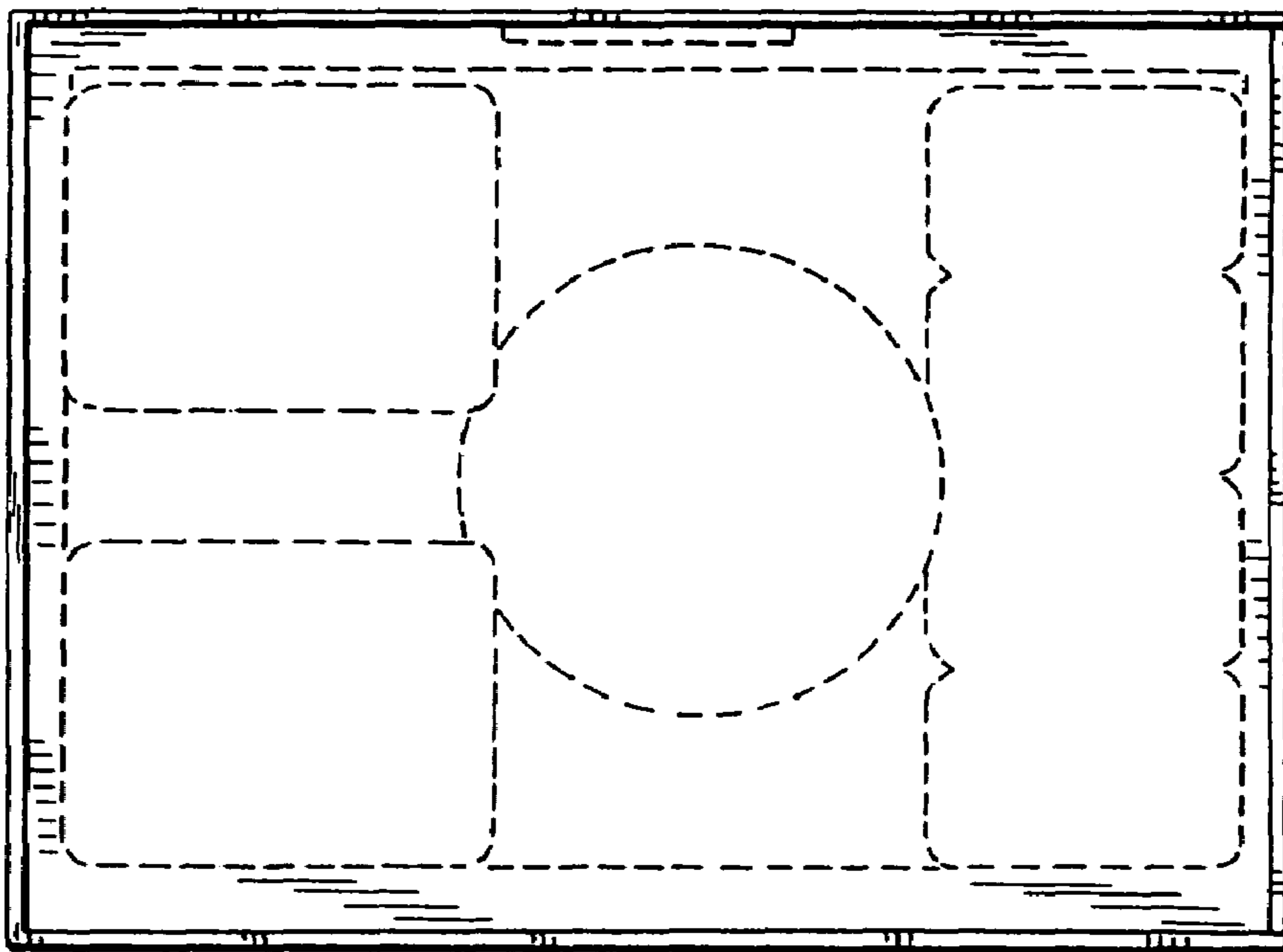

FIG. 10



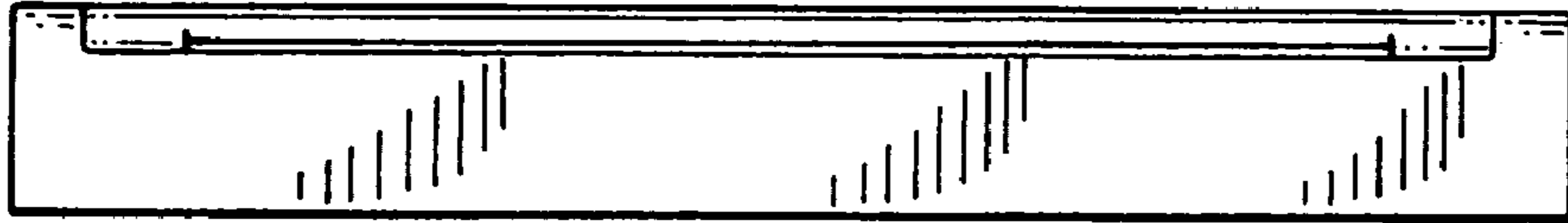

FIG. 12

FIG. 13

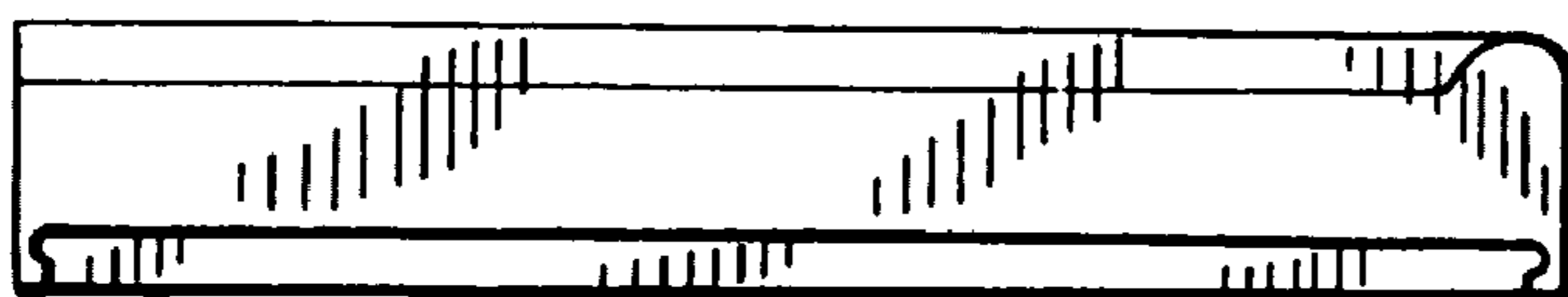
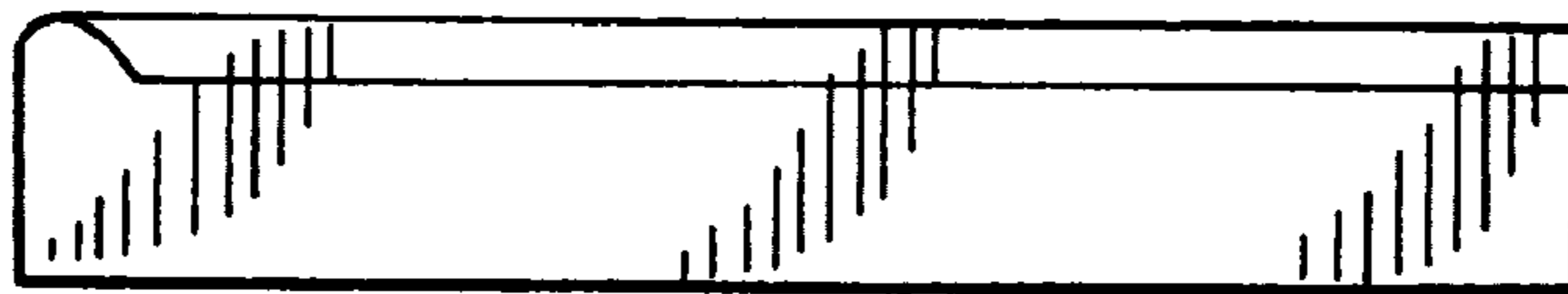

FIG. 14

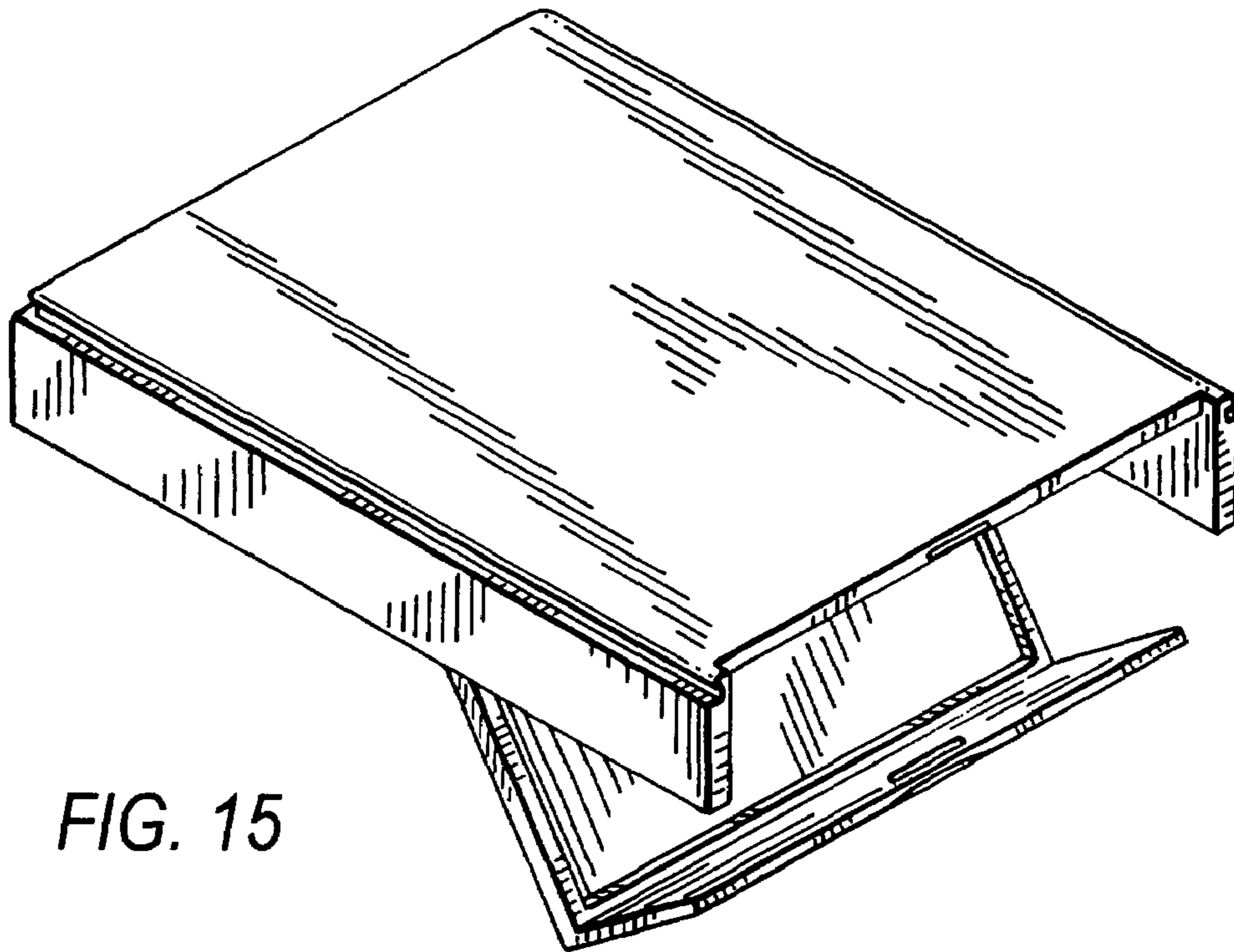

FIG. 15



FIG. 16

FIG. 17

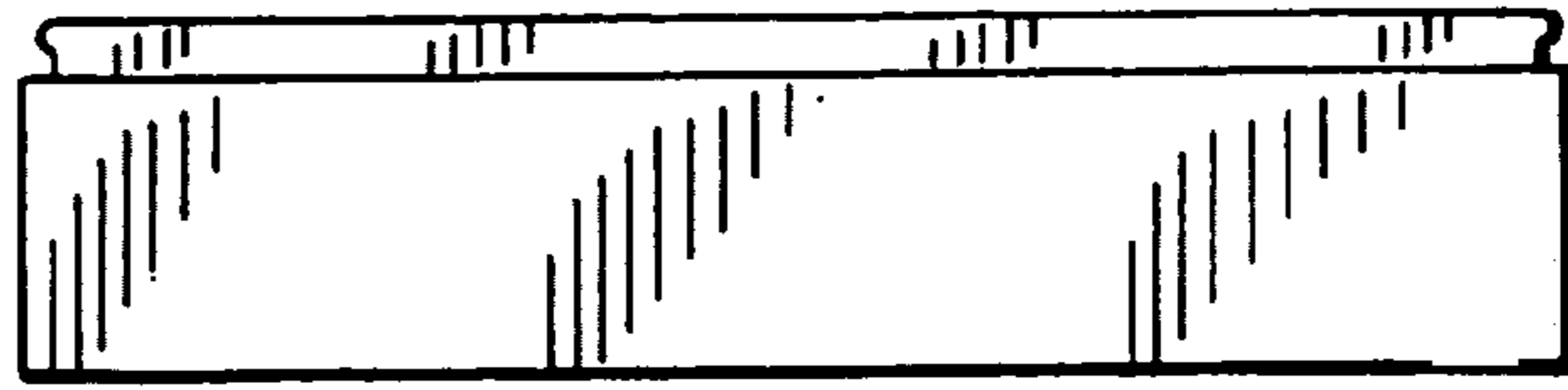

FIG. 18



FIG. 19

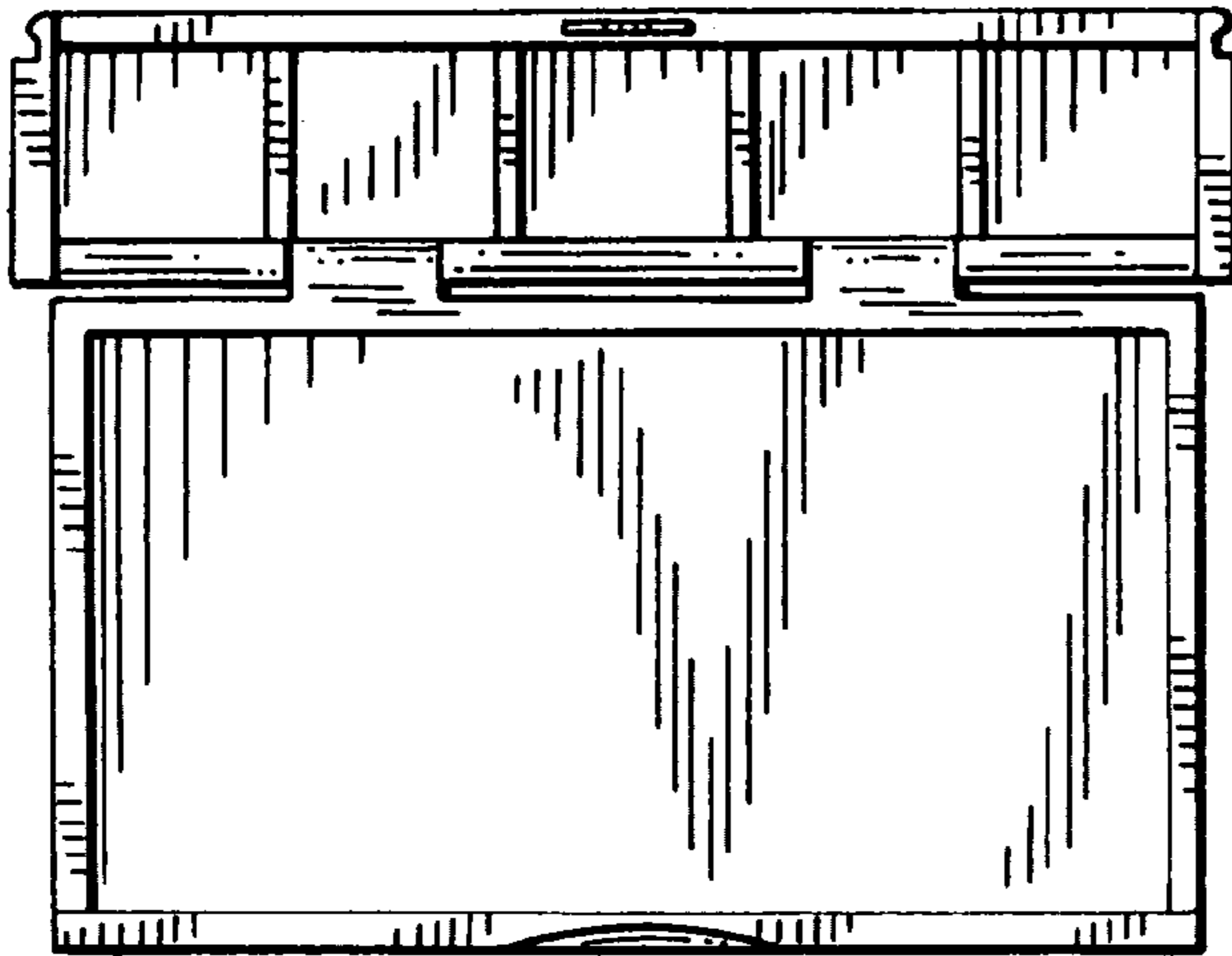

FIG. 20

