



US00D553789S

(12) **United States Design Patent**
Akinrele et al.

(10) **Patent No.:** **US D553,789 S**

(45) **Date of Patent:** **** Oct. 23, 2007**

(54) **LUMINAIRE**

(75) Inventors: **Dylan Akinrele**, Leonia, NJ (US);
Thomas Russello, Freehold, NJ (US)

(73) Assignee: **Genlyte Thomas Group, LLC**,
Louisville, KY (US)

(**) Term: **14 Years**

(21) Appl. No.: **29/197,941**

(22) Filed: **Jan. 22, 2004**

(51) **LOC (8) Cl.** **26-99**

(52) **U.S. Cl.** **D26/118**

(58) **Field of Classification Search** D26/113-136,
D26/67, 85, 71, 63; D30/199; 362/153,
362/147, 431, 307, 269, 310, 311, 404; D11/143,
D11/155

See application file for complete search history.

(56) **References Cited**

U.S. PATENT DOCUMENTS

D59,788 S	*	11/1921	Schwartz et al.	D26/128
D323,897 S	*	2/1992	Compton	D26/24
D336,534 S	*	6/1993	Lin	D26/63
D380,853 S	*	7/1997	Johnson	D26/128
D417,303 S	*	11/1999	Rahn	D26/67
D421,147 S	*	2/2000	Herst et al.	D26/113
D434,519 S	*	11/2000	Herst et al.	D26/113
D447,590 S	*	9/2001	Raouf et al.	D26/71

D456,551 S	*	4/2002	Russello et al.	D26/85
D456,552 S	*	4/2002	Russello et al.	D26/85
D456,928 S	*	5/2002	Russello et al.	D26/85
D459,519 S	*	6/2002	Russello et al.	D26/85
D468,046 S	*	12/2002	Bernard et al.	D26/85

* cited by examiner

Primary Examiner—Freda S. Nunn

Assistant Examiner—Kevin K. Rudzinski

(74) *Attorney, Agent, or Firm*—John F. Salazar; Middleton
Reutlinger

(57) **CLAIM**

The ornamental design for a luminaire, as shown and described.

DESCRIPTION

FIG. 1 is a perspective view of the design for a luminaire.

FIG. 2 is a top view of the design.

FIG. 3 is a front side view of the design.

FIG. 4 is a left side view of the design.

FIG. 5 is a right side view of the design.

FIG. 6 is a back side view of the design; and,

FIG. 7 is a bottom view of the design.

The broken lines are for illustrative purposes only and form no part of the claimed design.

1 Claim, 7 Drawing Sheets

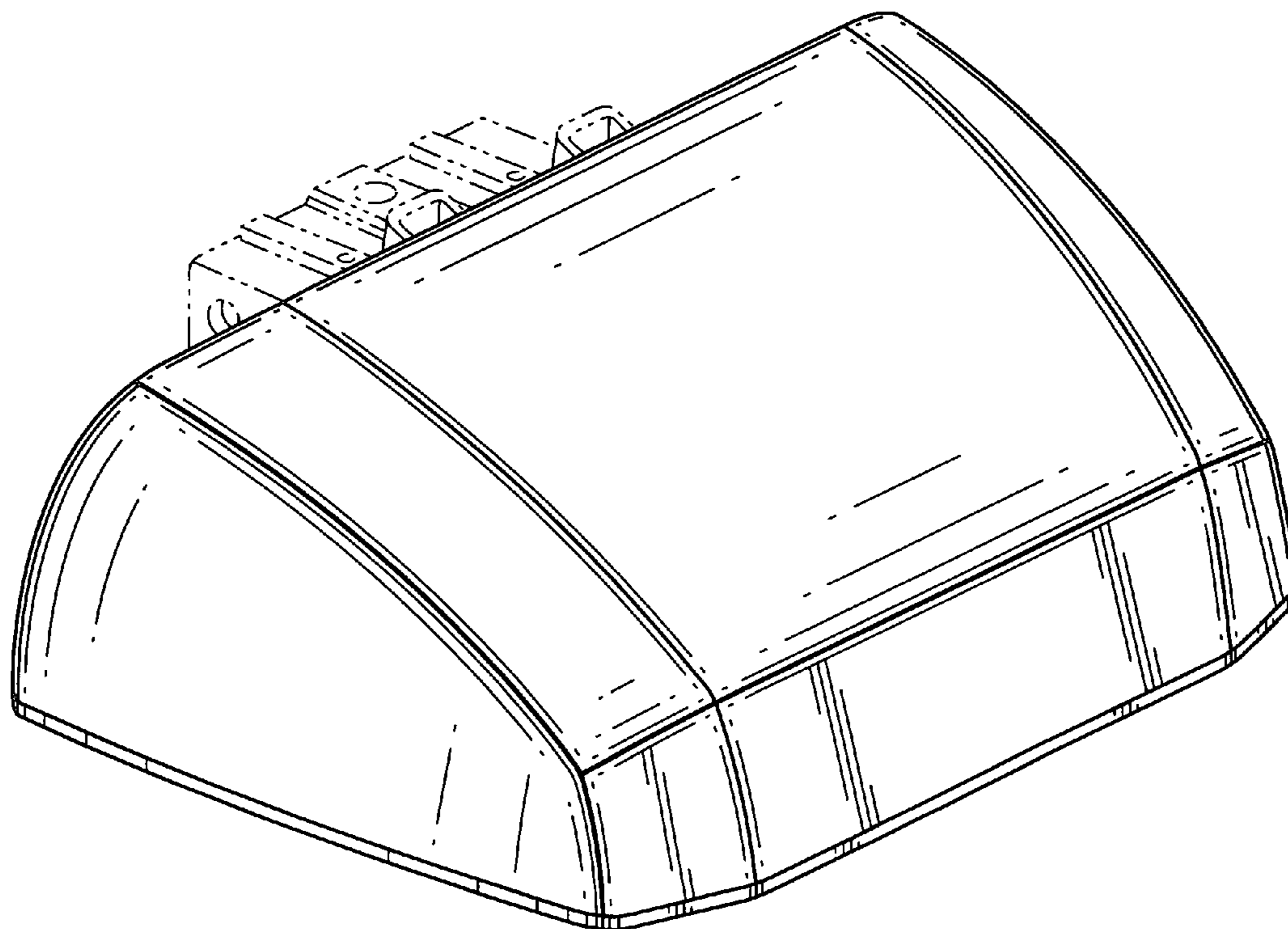

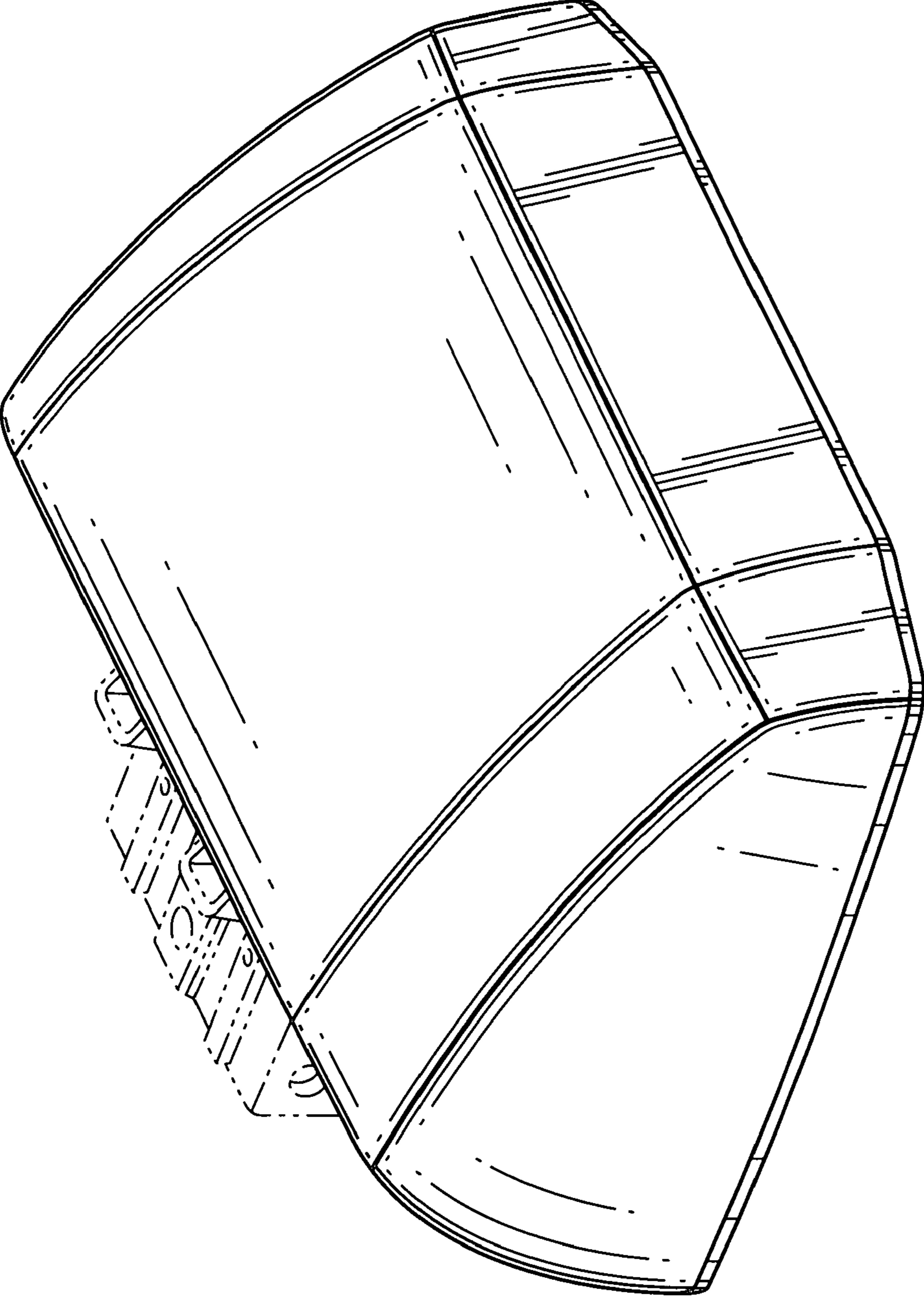

FIG. 1

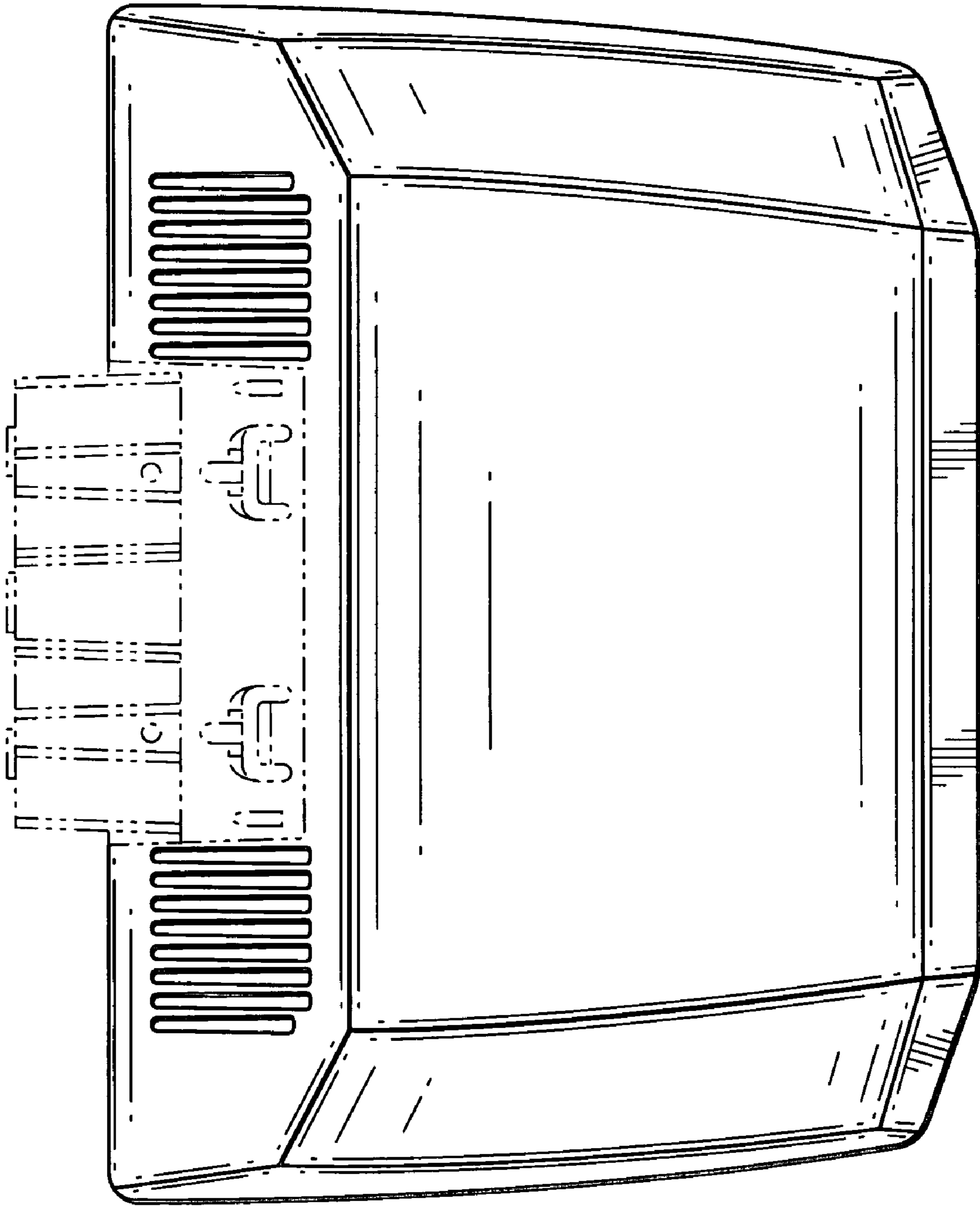

FIG. 2

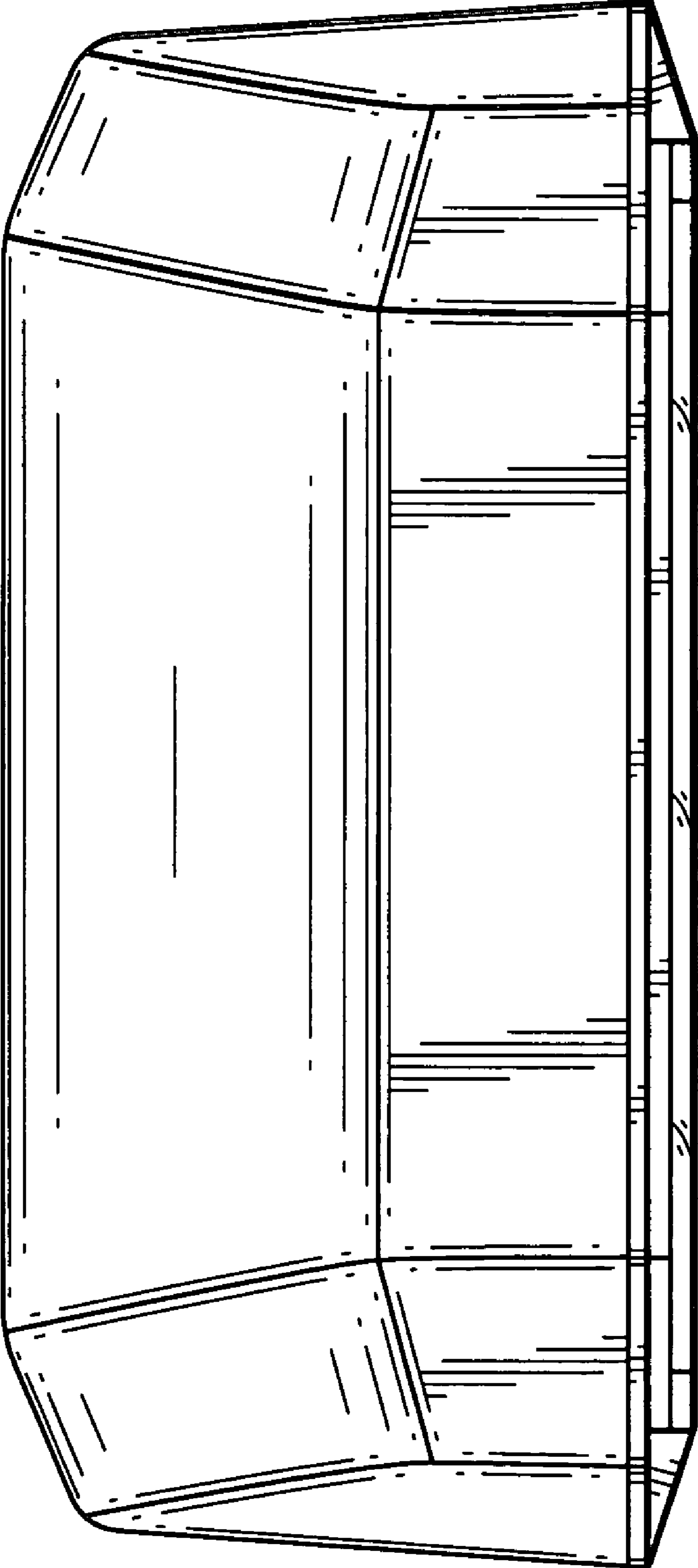

FIG. 3

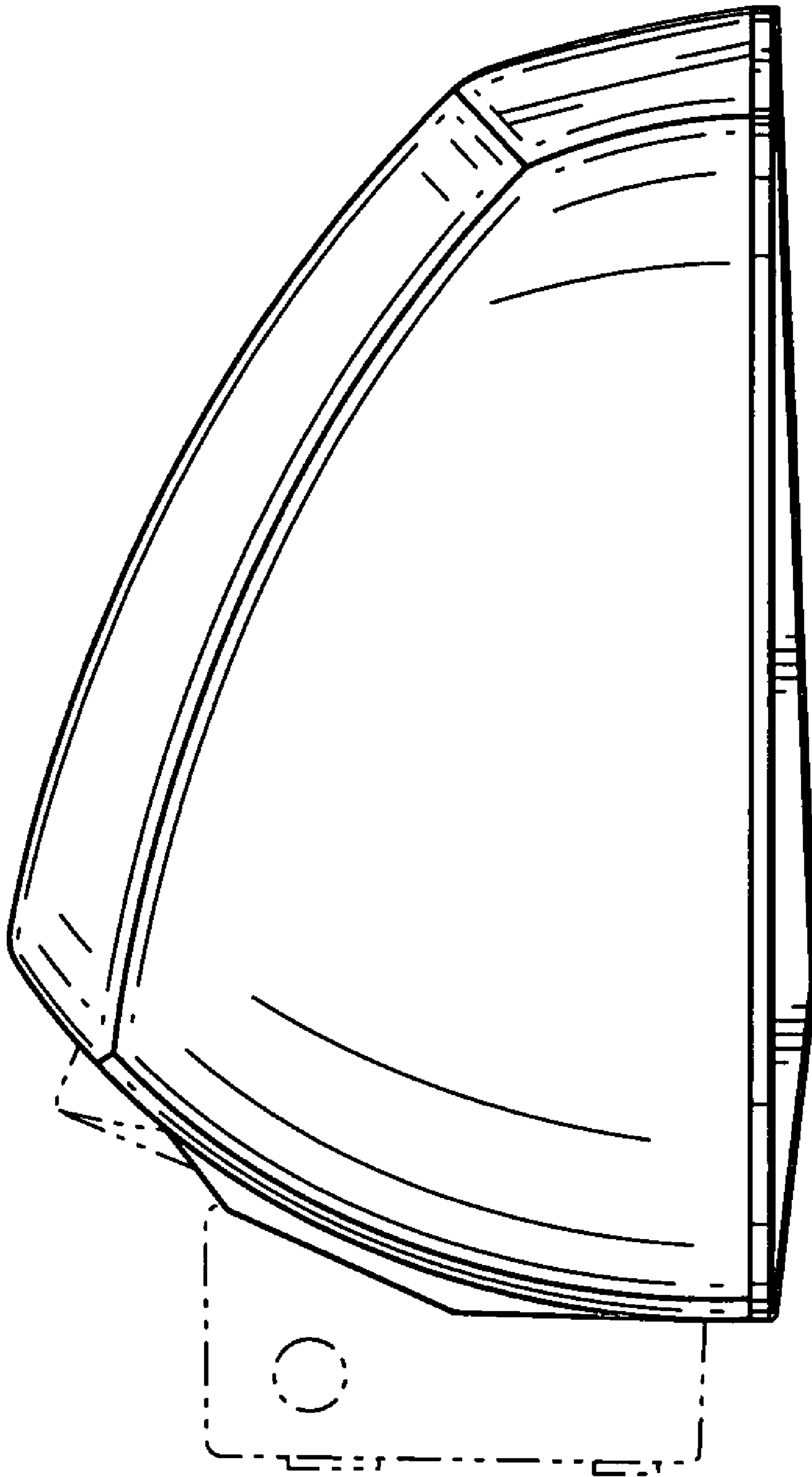

FIG. 4

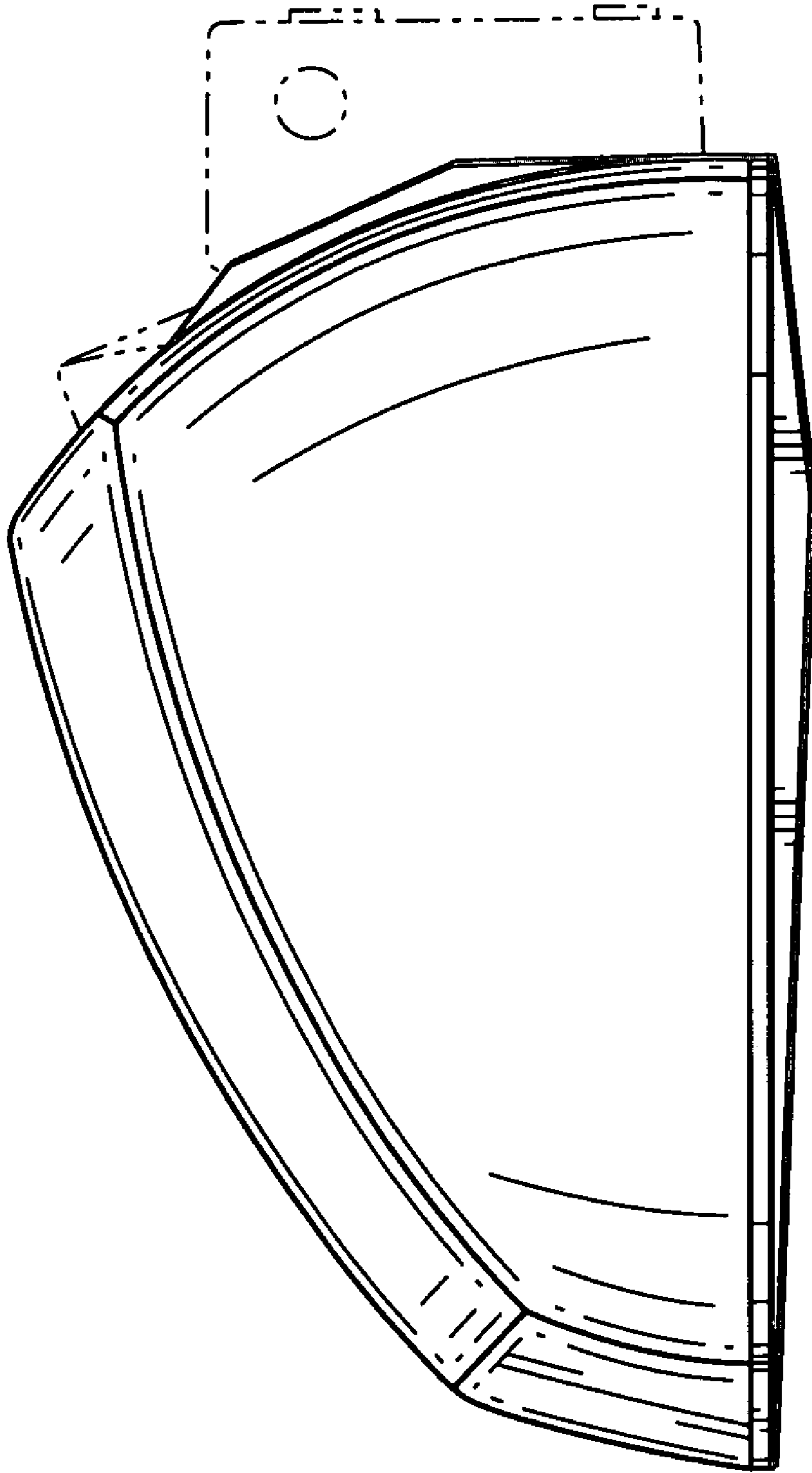

FIG. 5

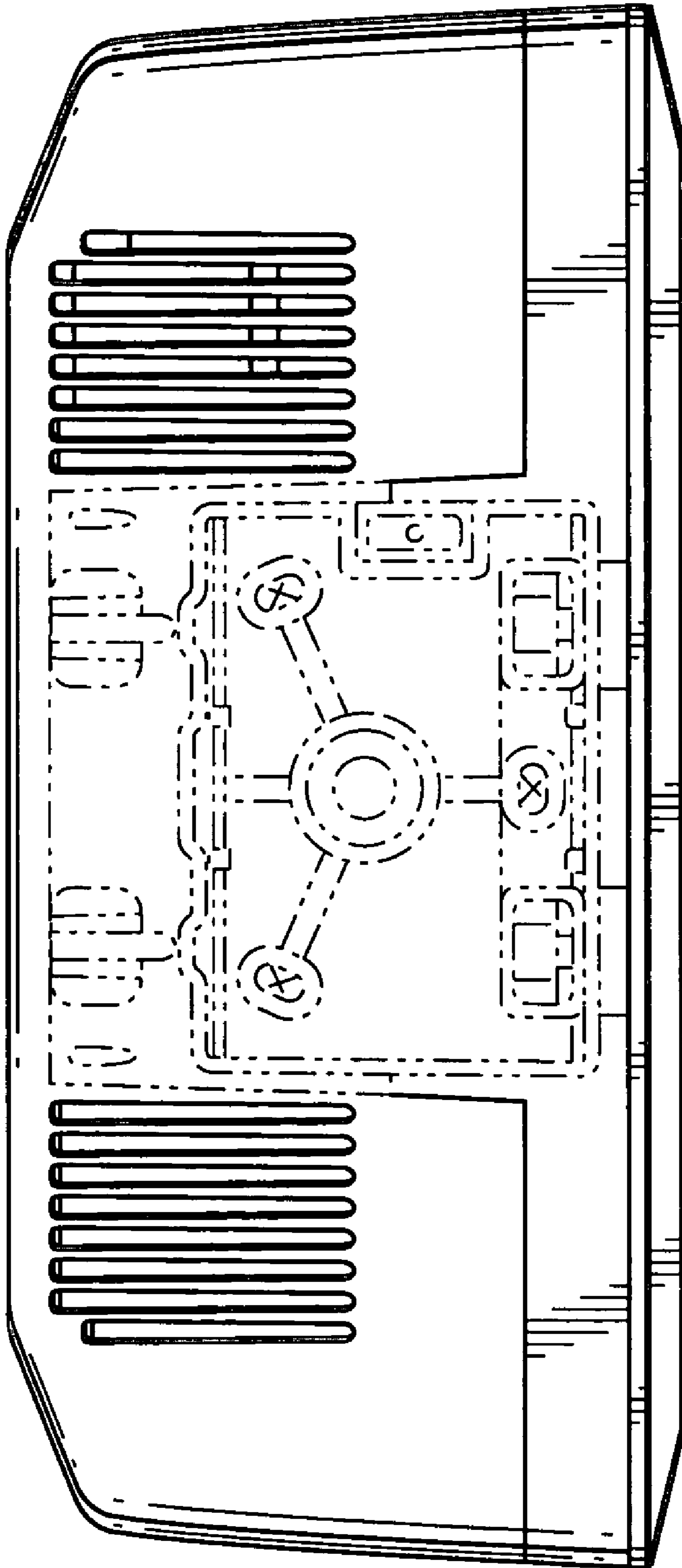

FIG. 6

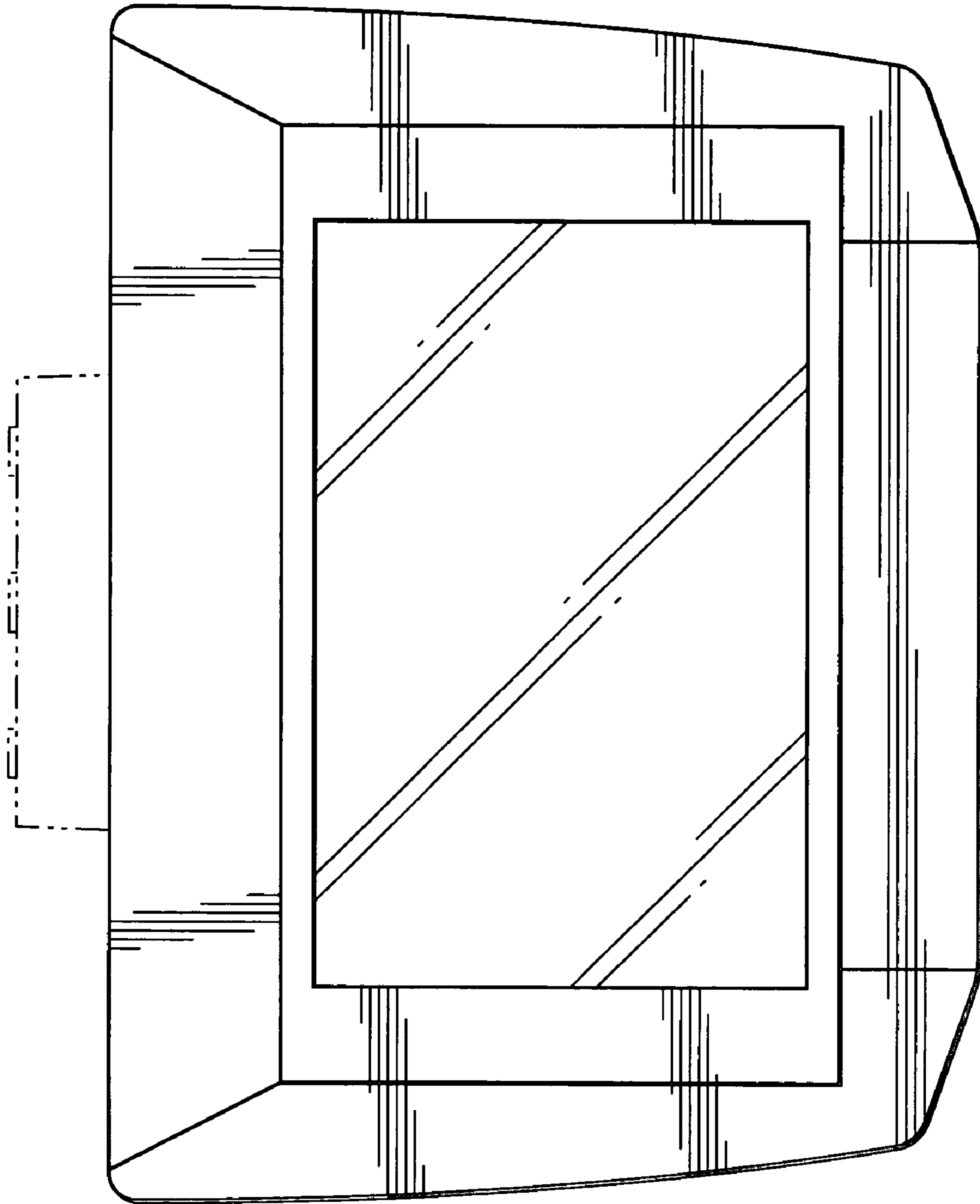

FIG. 7