



US00D553780S

(12) **United States Design Patent**  
**Bucher et al.**

(10) **Patent No.:** **US D553,780 S**

(45) **Date of Patent:** **\*\* Oct. 23, 2007**

(54) **LAMP**

(75) Inventors: **John C. Bucher**, Ft. Lauderdale, FL (US); **Shouping Wang**, Taichung (TW)

(73) Assignee: **King of Fans, Inc.**, Ft. Lauderdale, FL (US)

(\*\*) Term: **14 Years**

(21) Appl. No.: **29/258,035**

(22) Filed: **Apr. 14, 2006**

(51) **LOC (8) Cl.** ..... **26-05**

(52) **U.S. Cl.** ..... **D26/67; D26/85**

(58) **Field of Classification Search** ..... D26/8, D26/67, 68, 71, 85, 118, 128-130; 362/145, 362/152, 153, 153.1, 183, 266, 431, 312, 362/314, 356, 363, 415, 806; 431/320  
See application file for complete search history.

(56) **References Cited**

**U.S. PATENT DOCUMENTS**

- D100,556 S \* 7/1936 Gosling ..... D26/67
- D129,831 S \* 10/1941 Davidson ..... D26/67
- D526,081 S \* 8/2006 Wen ..... D26/67
- D531,340 S \* 10/2006 Victor ..... D26/67

**OTHER PUBLICATIONS**

“Cheswick” fixtures on p. 280 of the Seagull Lighting 2004 Catalog—04A. (c)2003.\*

\* cited by examiner

*Primary Examiner*—Clare E Heflin

(74) *Attorney, Agent, or Firm*—MacPherson Kwok Chen & Heid LLP

(57) **CLAIM**

The ornamental design for a lamp, as shown and described.

**DESCRIPTION**

FIG. 1 is a perspective view of the first embodiment of a lamp showing my new design;

FIG. 2 is a front elevational view thereof;

FIG. 3 is a rear elevational view thereof;

FIG. 4 is a left side elevational view thereof;

FIG. 5 is a right side elevational view thereof;

FIG. 6 is a top plan view thereof;

FIG. 7 is a bottom plan view thereof;

FIG. 8 is a perspective view of the second embodiment of a lamp;

FIG. 9 is a front elevational view thereof;

FIG. 10 is a rear elevational view thereof;

FIG. 11 is a left side elevational view thereof;

FIG. 12 is a right side elevational view thereof;

FIG. 13 is a top plan view thereof; and,

FIG. 14 is a bottom plan view thereof.

**1 Claim, 8 Drawing Sheets**

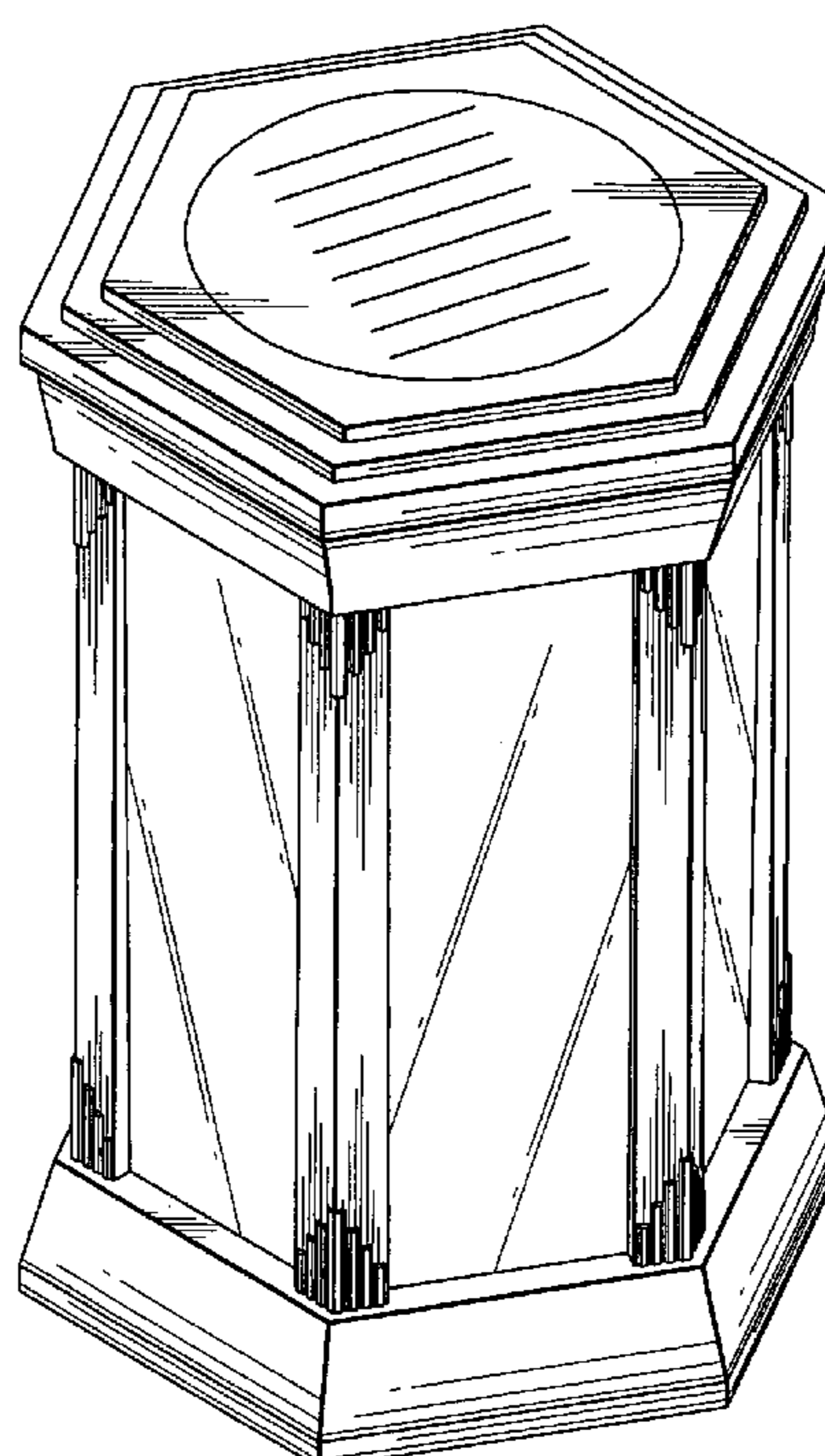
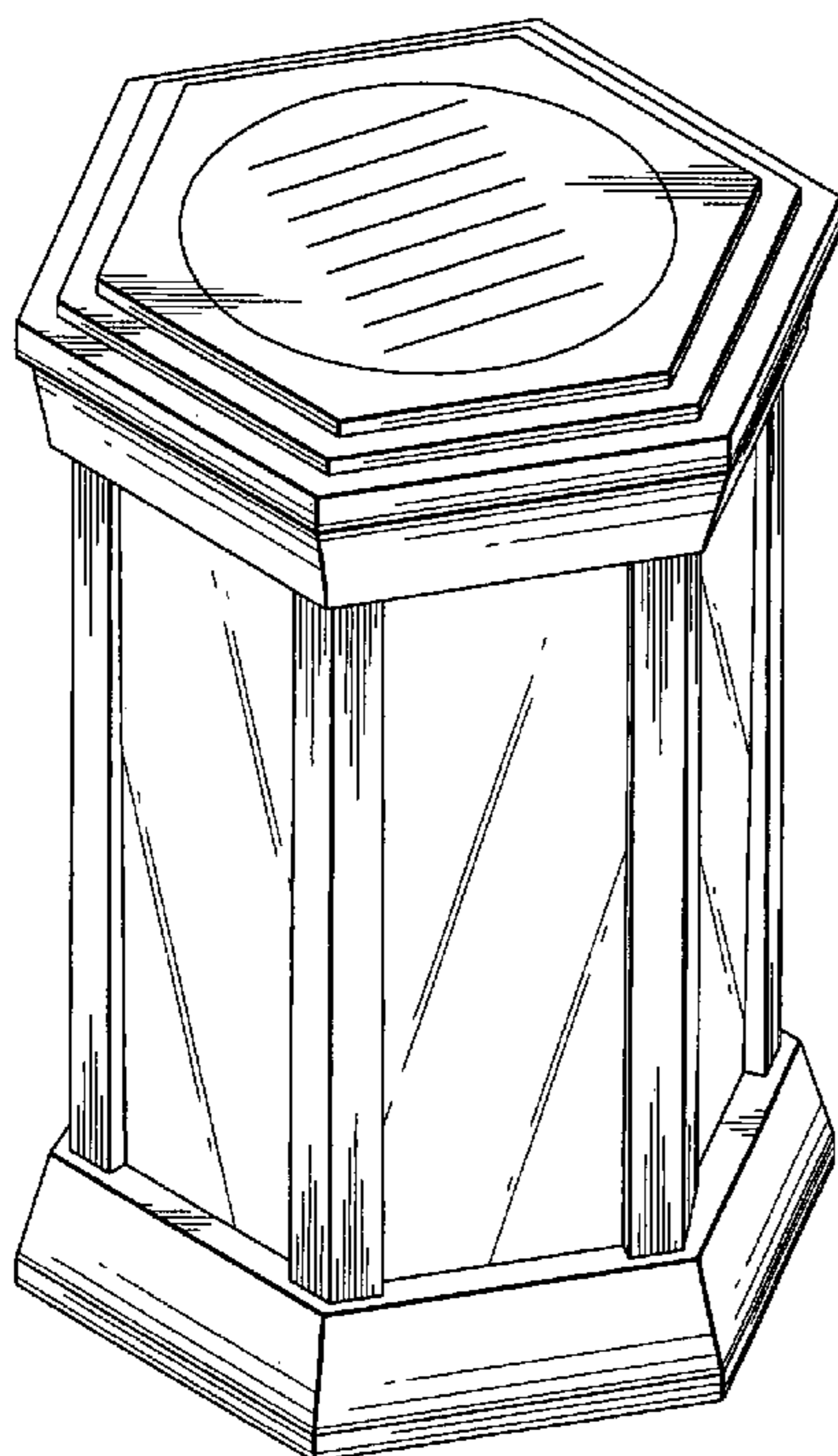

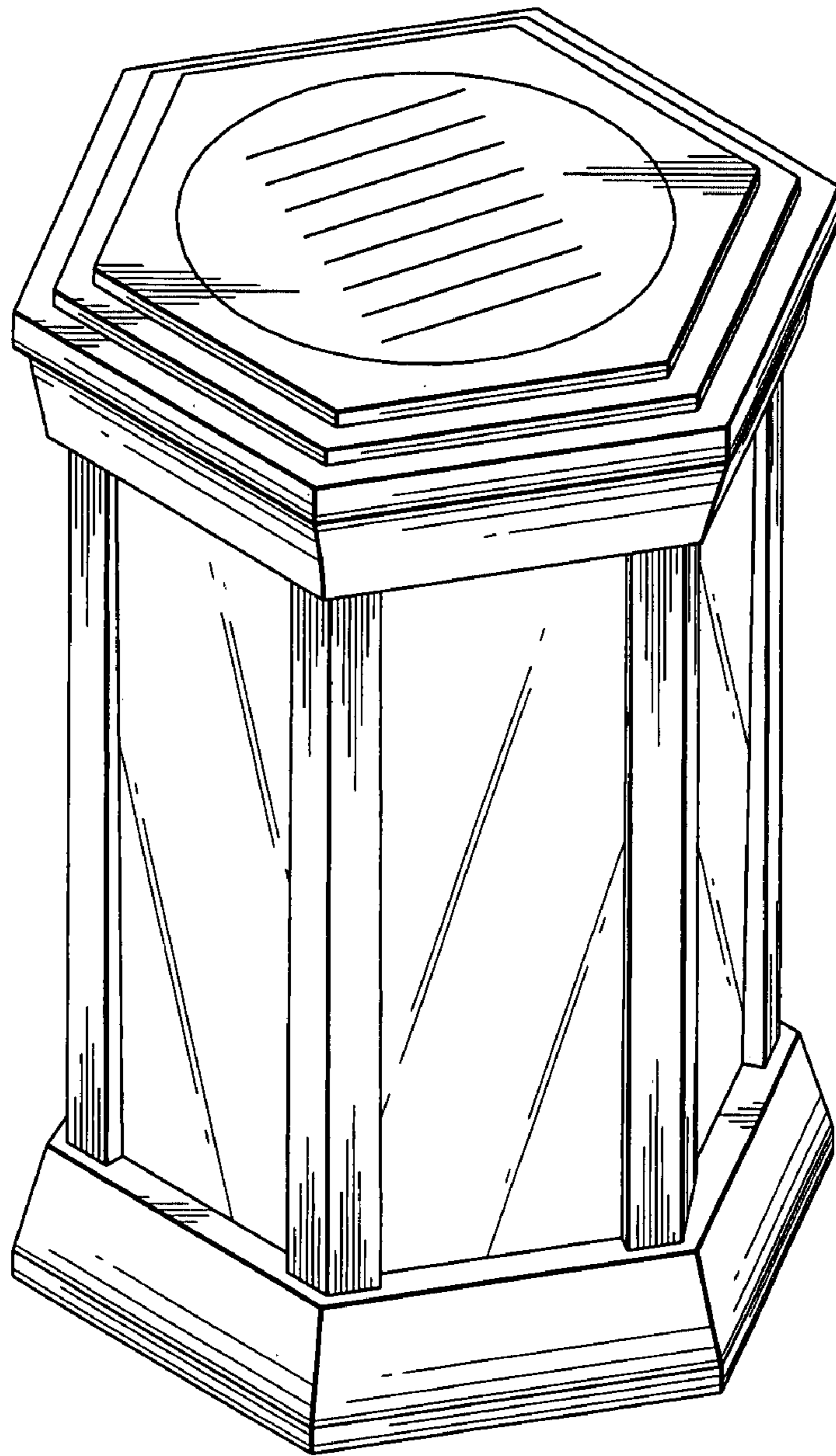

FIG. 1

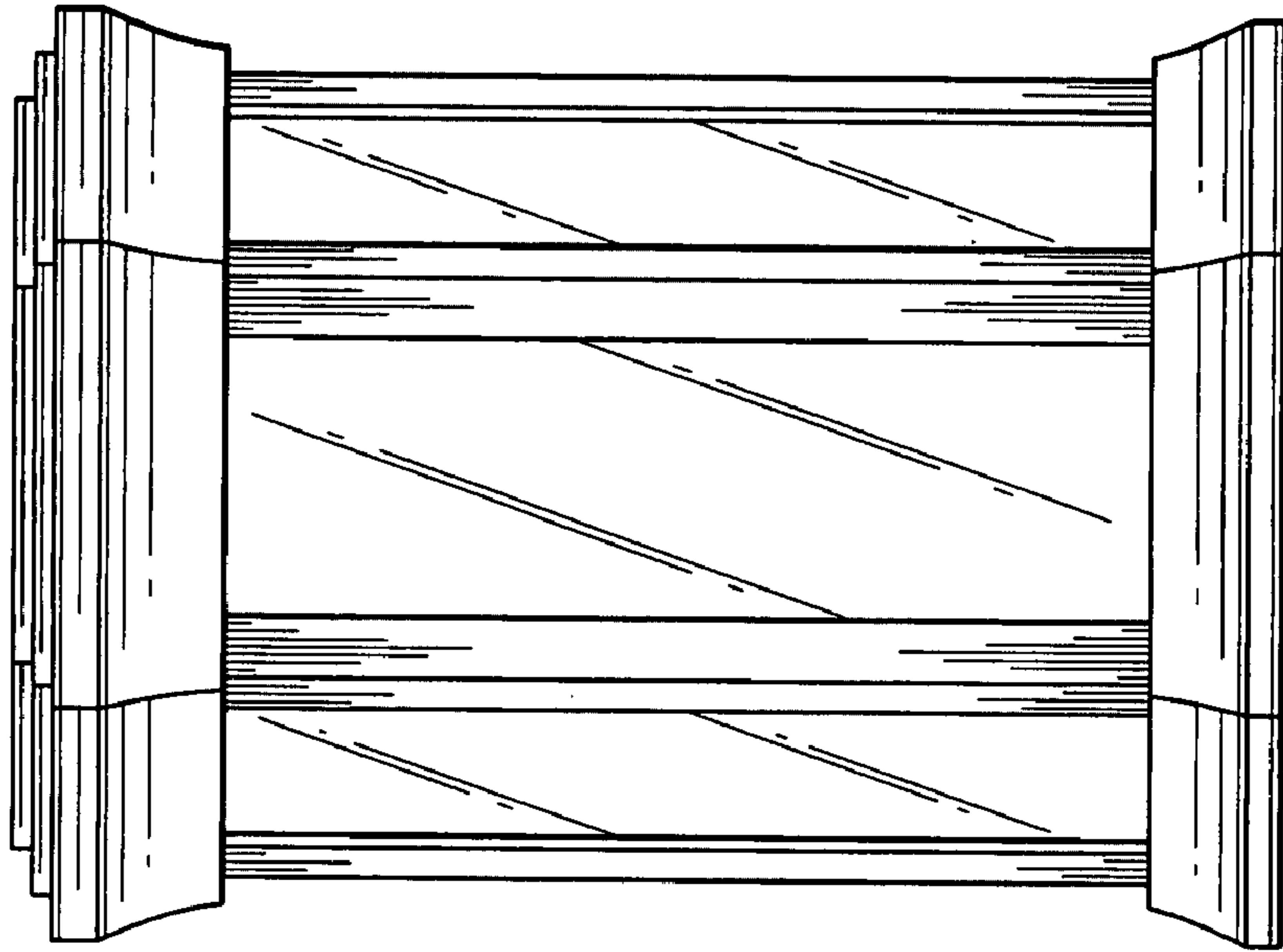

FIG. 3

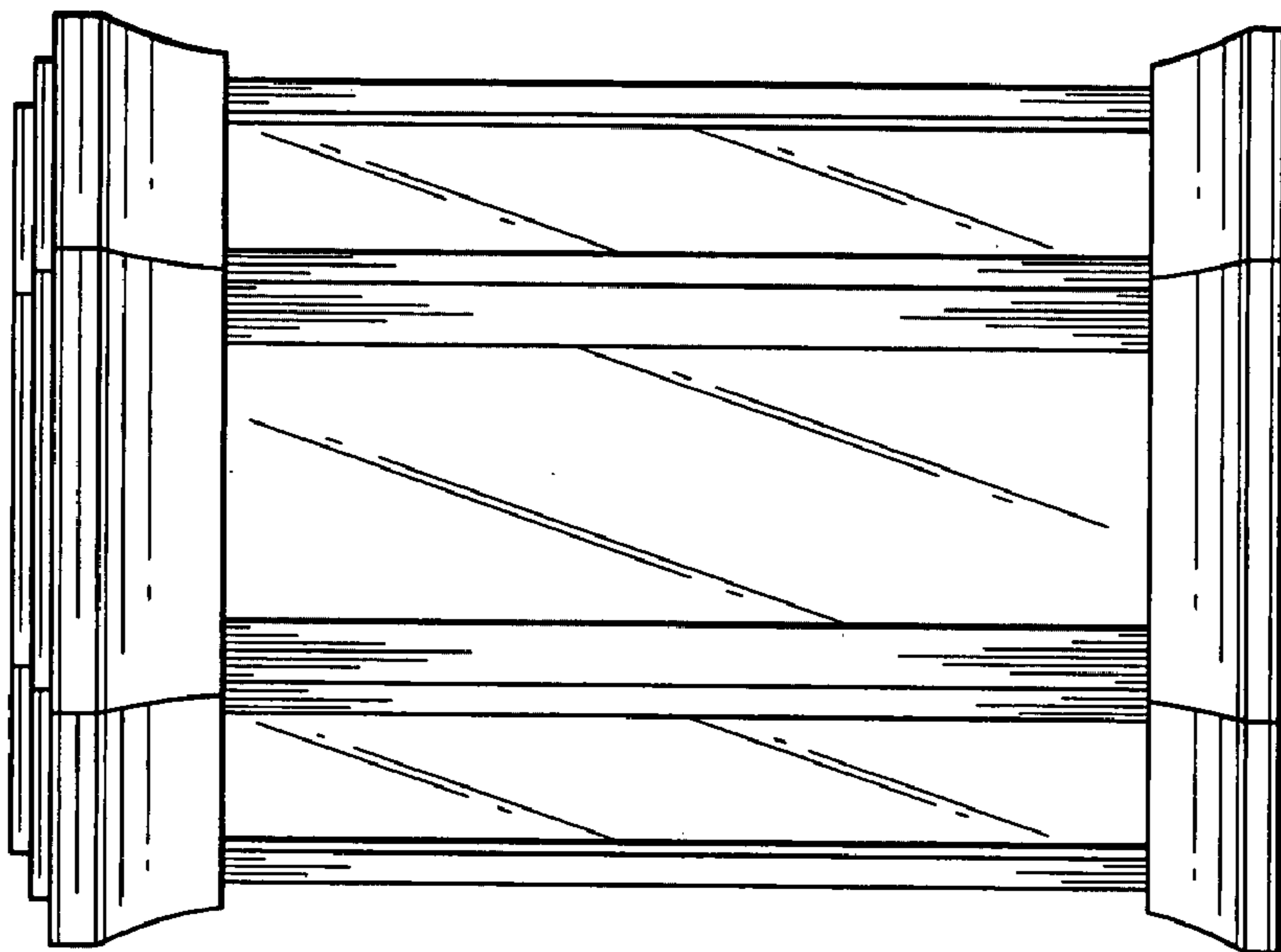

FIG. 2

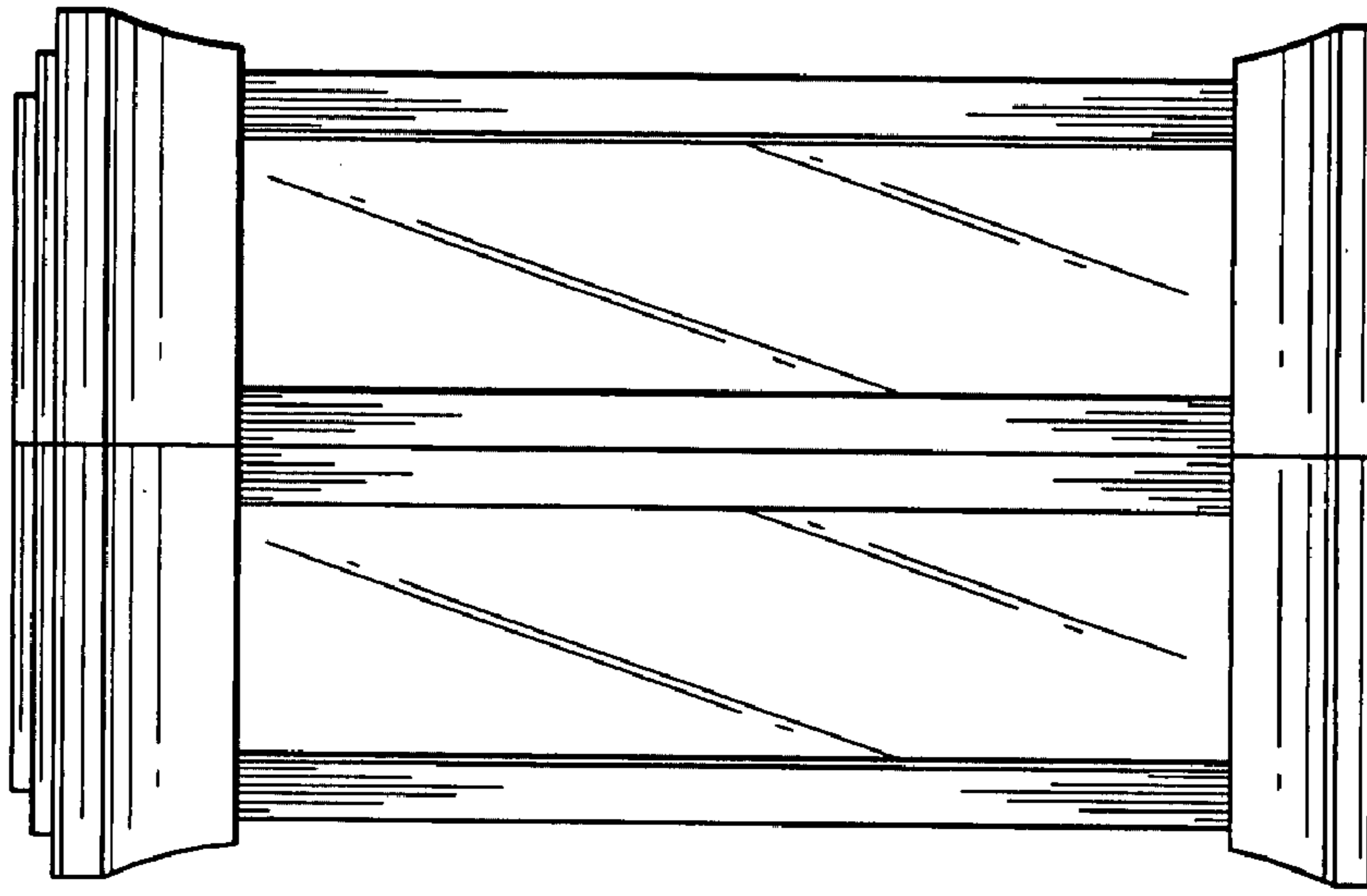

FIG. 5

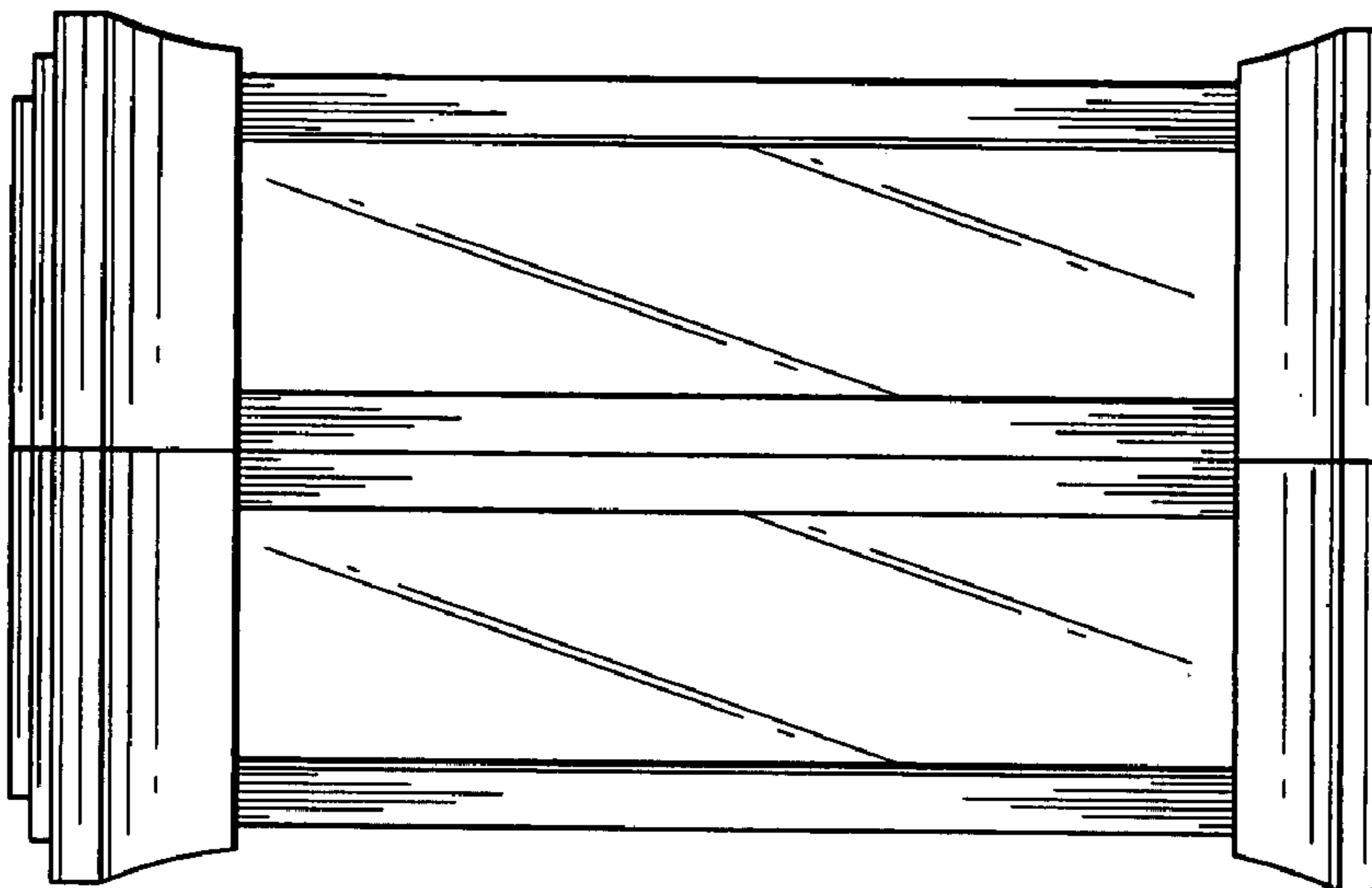

FIG. 4

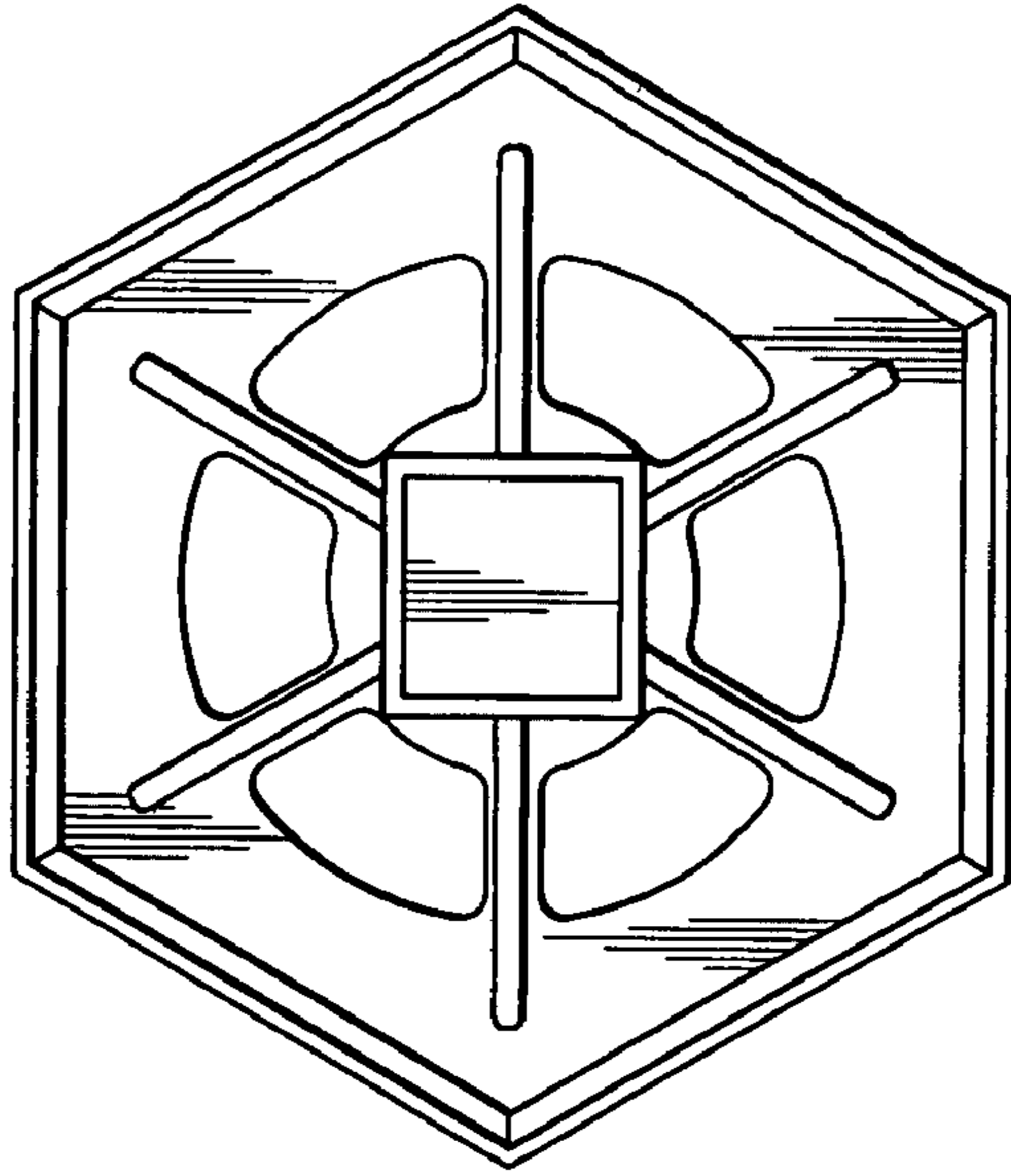

FIG. 7

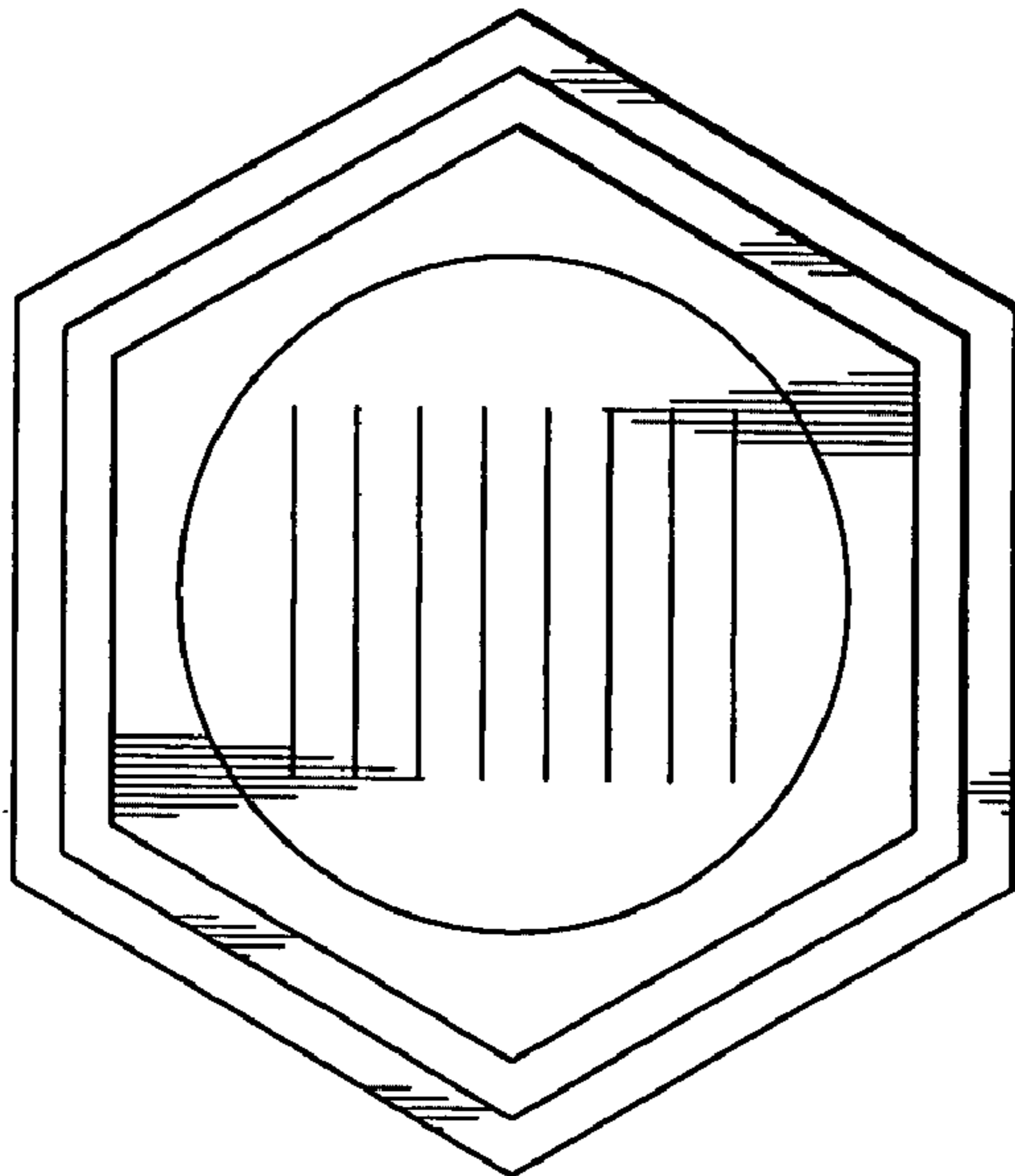

FIG. 6



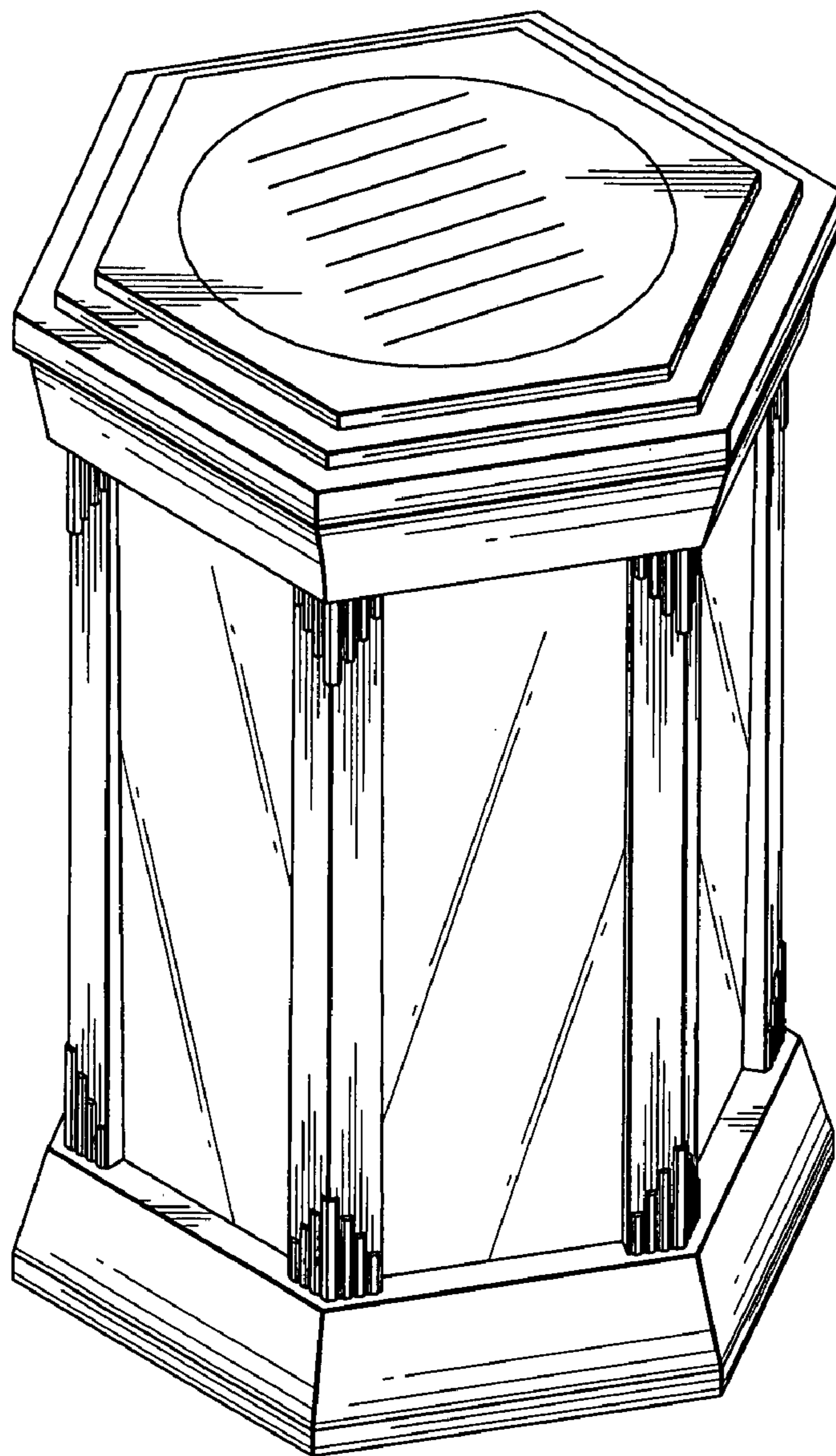

FIG. 8

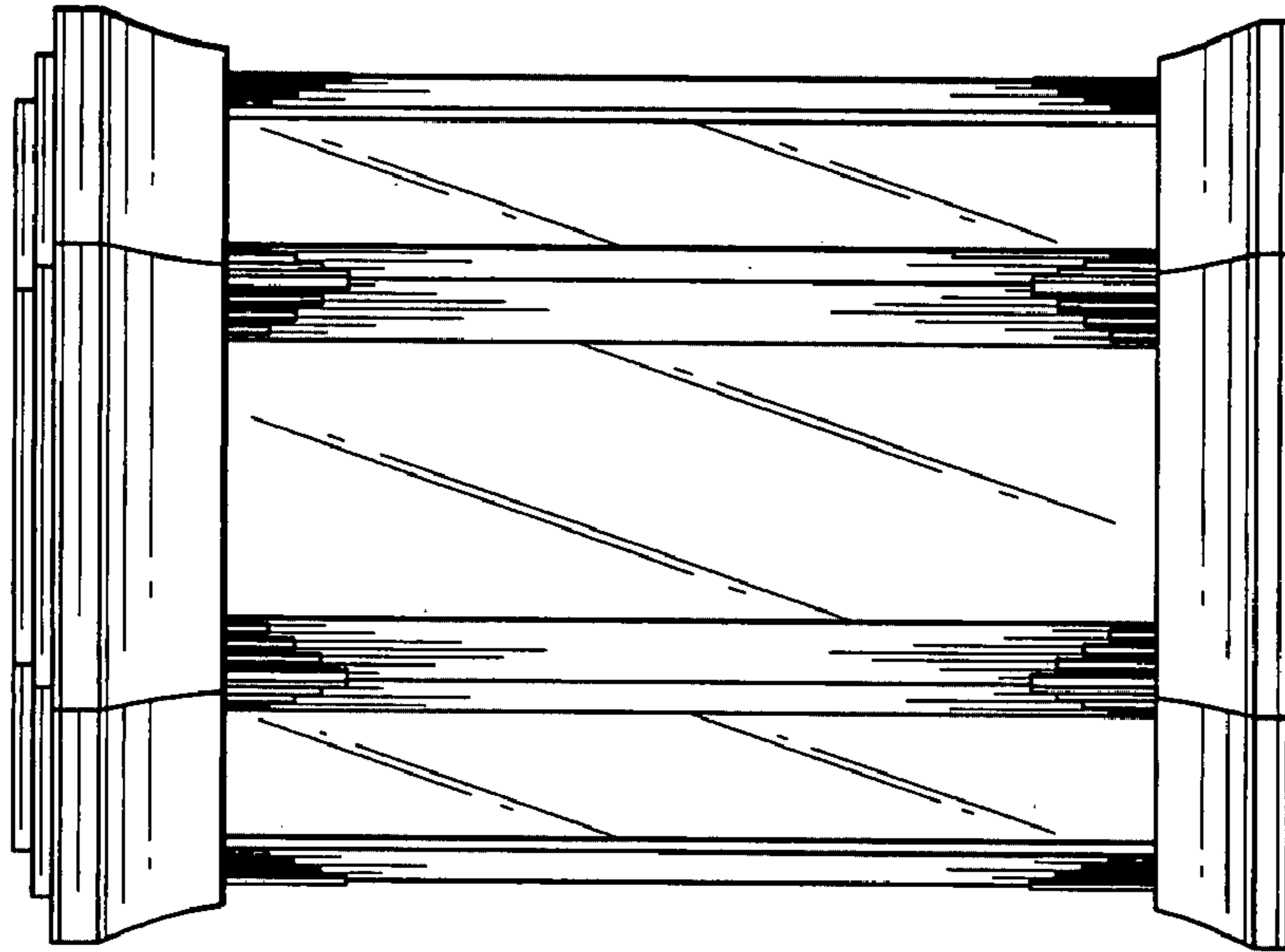

FIG. 10

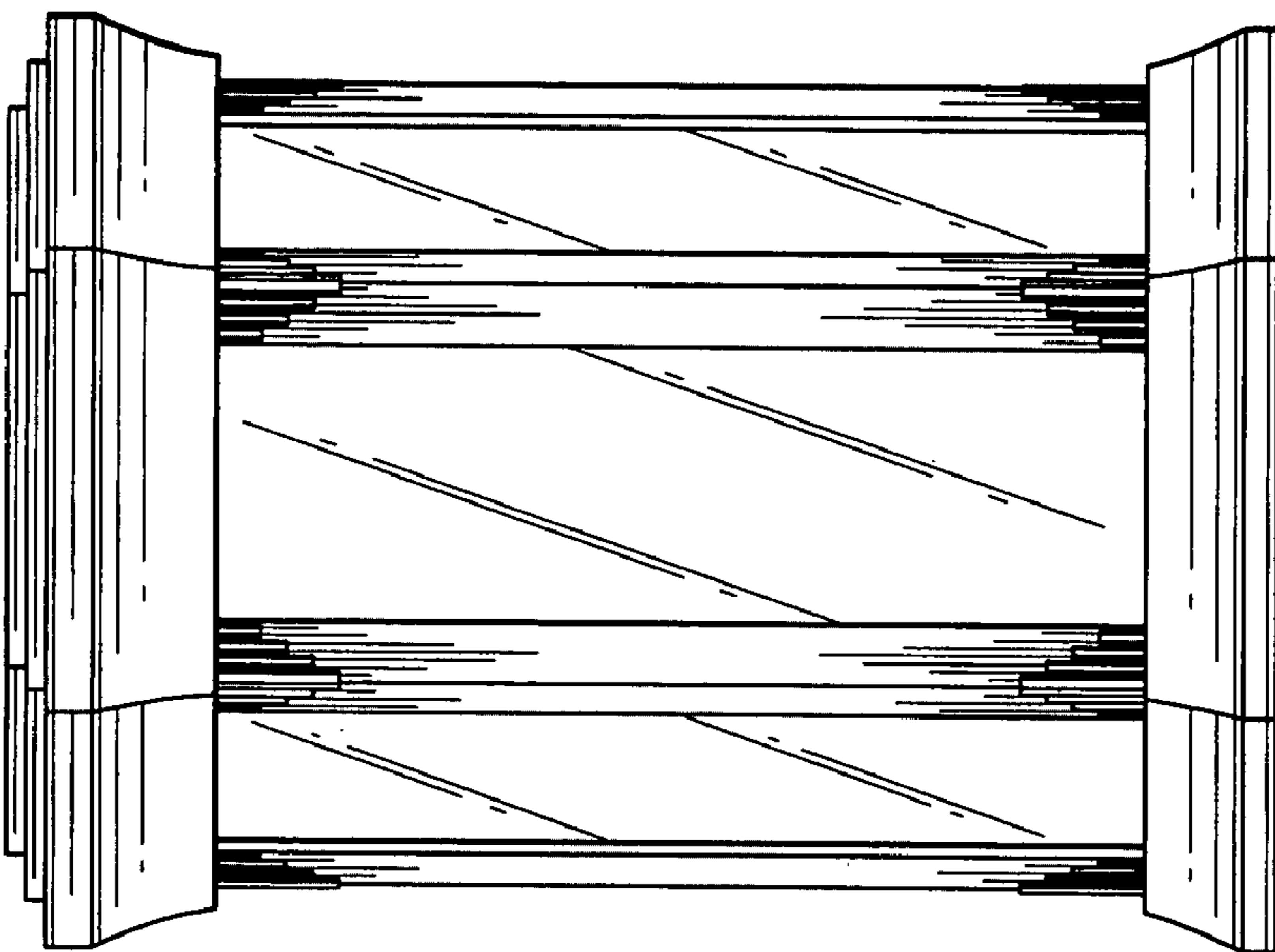

FIG. 9

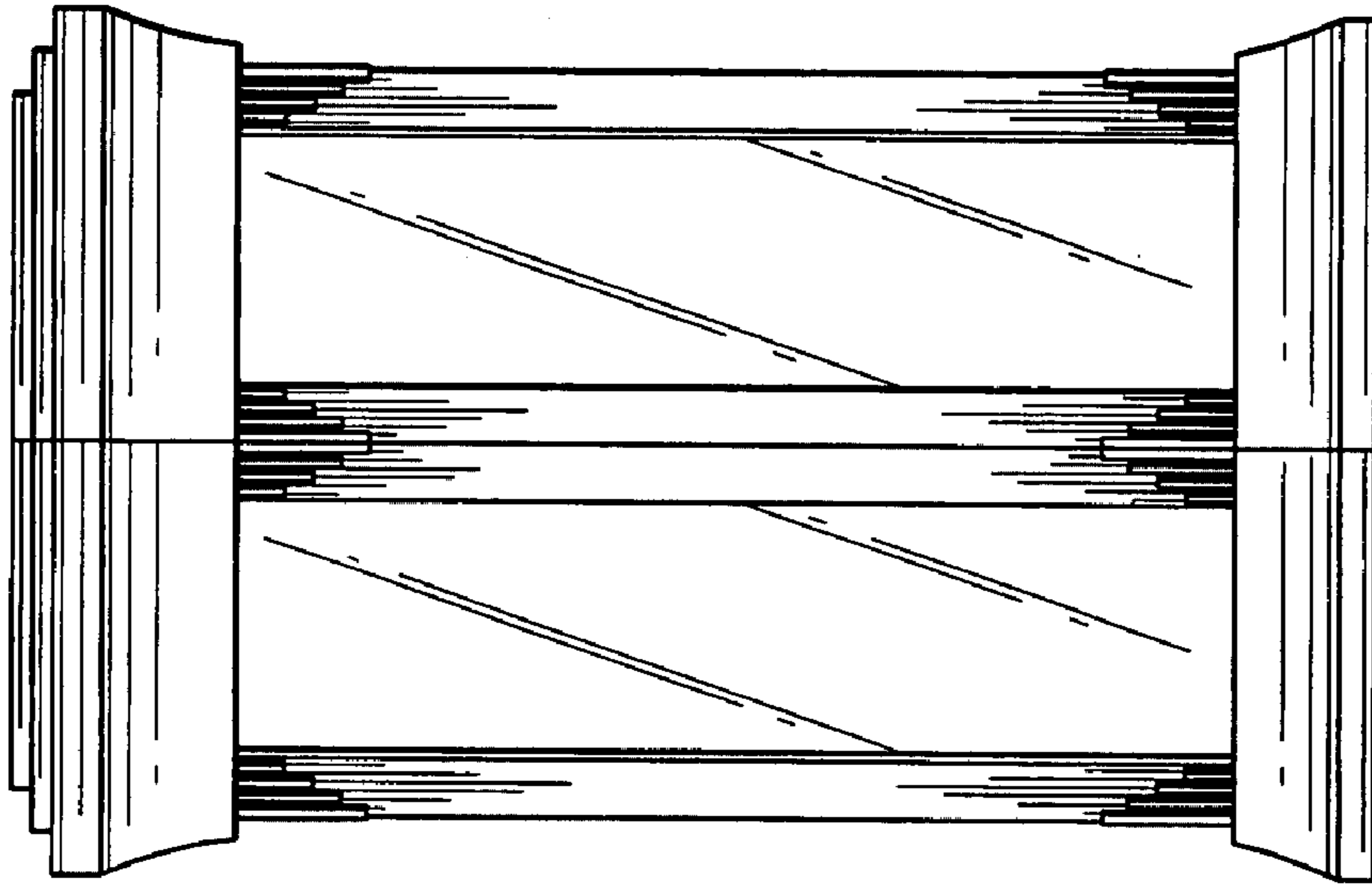

FIG. 11

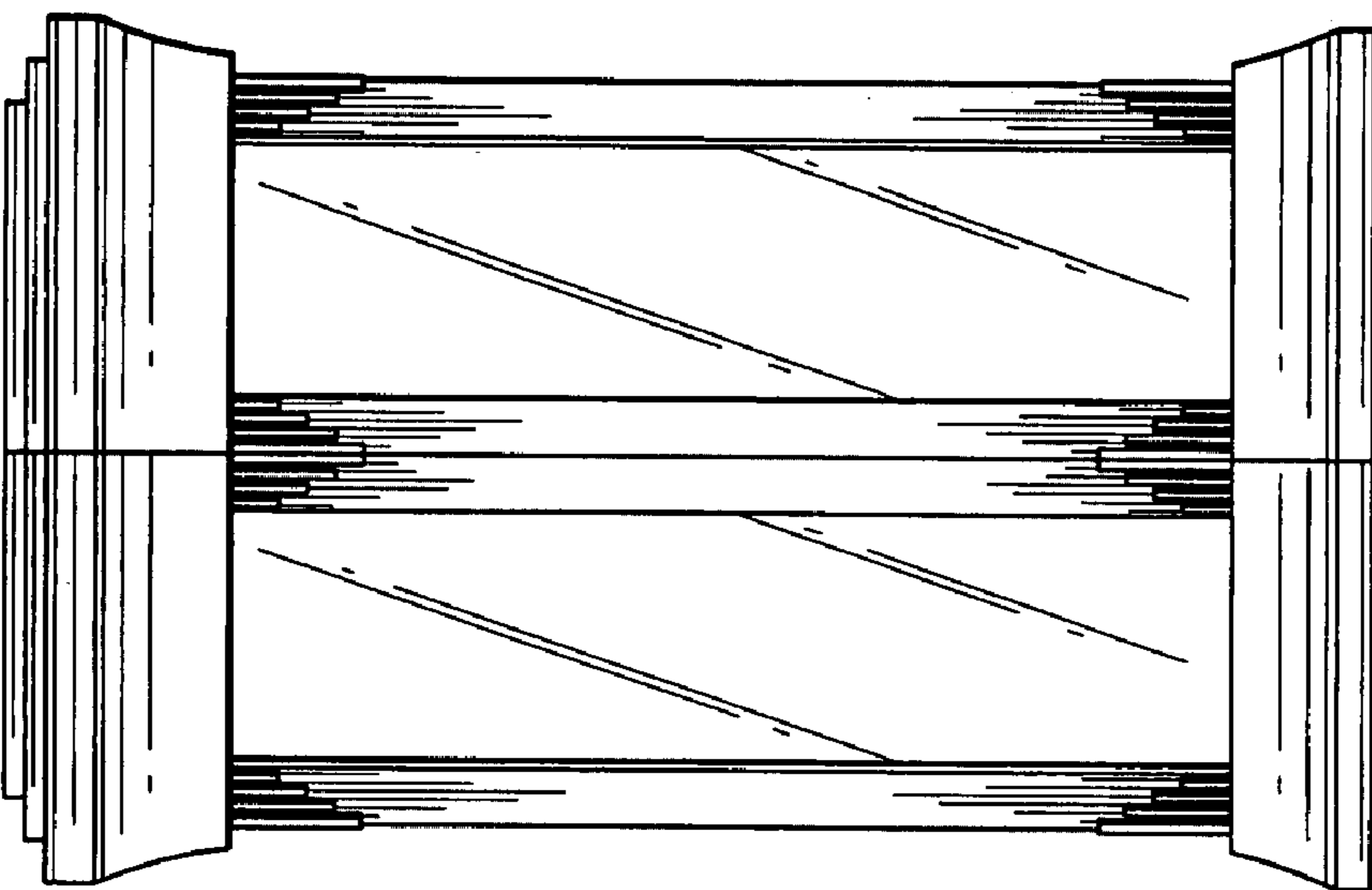

FIG. 12



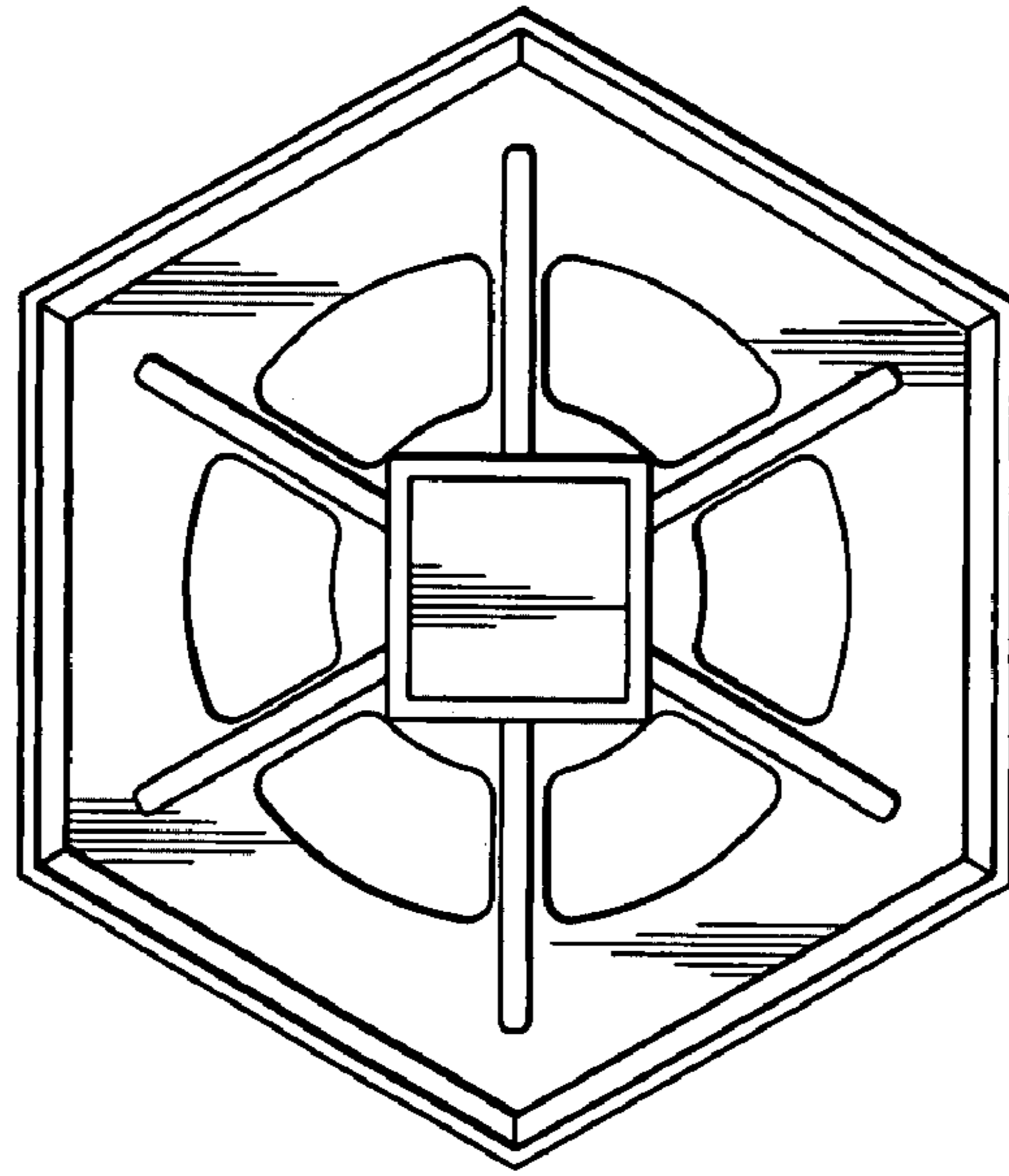

FIG. 14

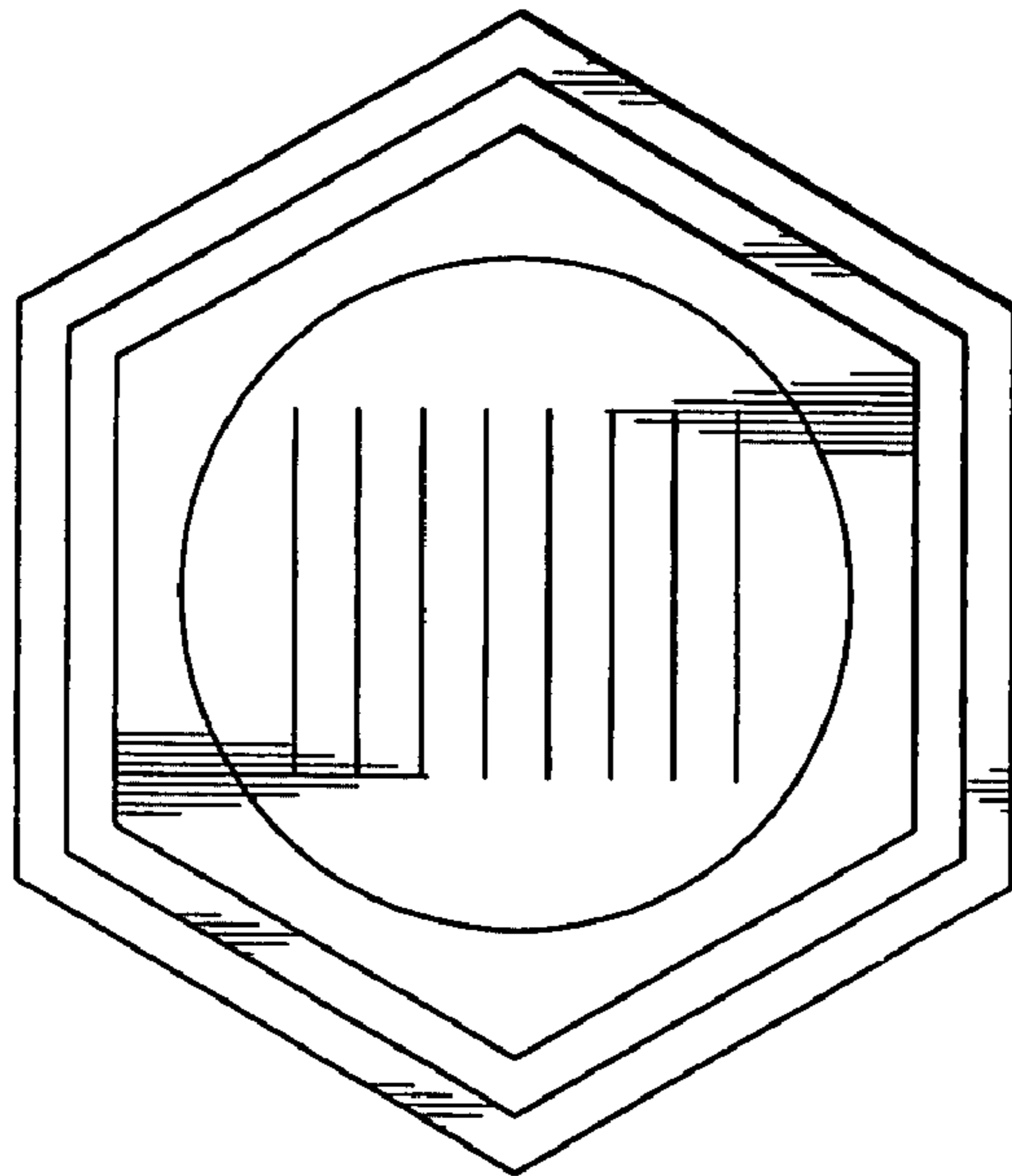

FIG. 13