



US00D553768S

(12) **United States Design Patent**
Pan

(10) **Patent No.:** **US D553,768 S**

(45) **Date of Patent:** **** Oct. 23, 2007**

(54) **CLEARANCE SIDEMARKER AND IDENTIFICATION LAMP**

D534,285 S * 12/2006 Williams D26/28
D535,044 S * 1/2007 Branstetter et al. D26/28

(75) Inventor: **Ko-Chun Pan**, Tainan (TW)

* cited by examiner

(73) Assignee: **Lucidity Enterprise Co., Ltd.**, An-Nan District, Tainan (TW)

Primary Examiner—Marcus A. Jackson

(**) Term: **14 Years**

(57) **CLAIM**

(21) Appl. No.: **29/274,535**

The ornamental design for a clearance sidemarker and identification lamp, as shown and described.

(22) Filed: **Apr. 30, 2007**

DESCRIPTION

(51) **LOC (8) Cl.** **26-06**

FIG. 1 is a perspective view of a clearance sidemarker and identification lamp showing my design;

(52) **U.S. Cl.** **D26/28**

FIG. 2 is a front elevational view thereof;

(58) **Field of Classification Search** D26/28-36;
362/459-468, 475-478, 485-487

FIG. 3 is a rear elevational view thereof;

See application file for complete search history.

FIG. 4 is a left side elevational view thereof;

FIG. 5 is a right side elevational view thereof;

(56) **References Cited**

U.S. PATENT DOCUMENTS

D519,656 S * 4/2006 Howser D26/28
D524,463 S * 7/2006 Branstetter et al. D26/28

FIG. 6 is a top plan view thereof; and,

FIG. 7 is a bottom plan view thereof.

1 Claim, 5 Drawing Sheets

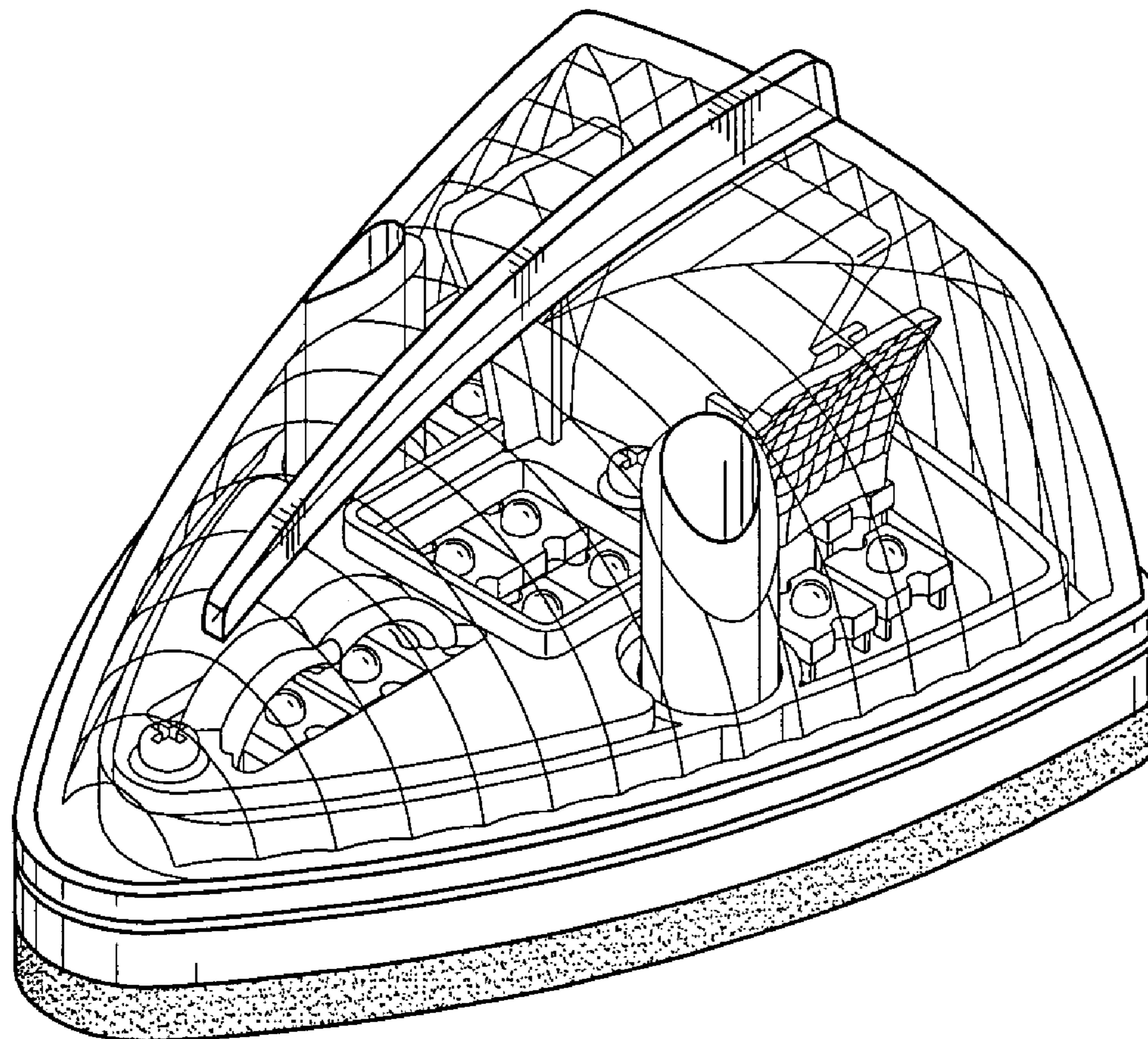

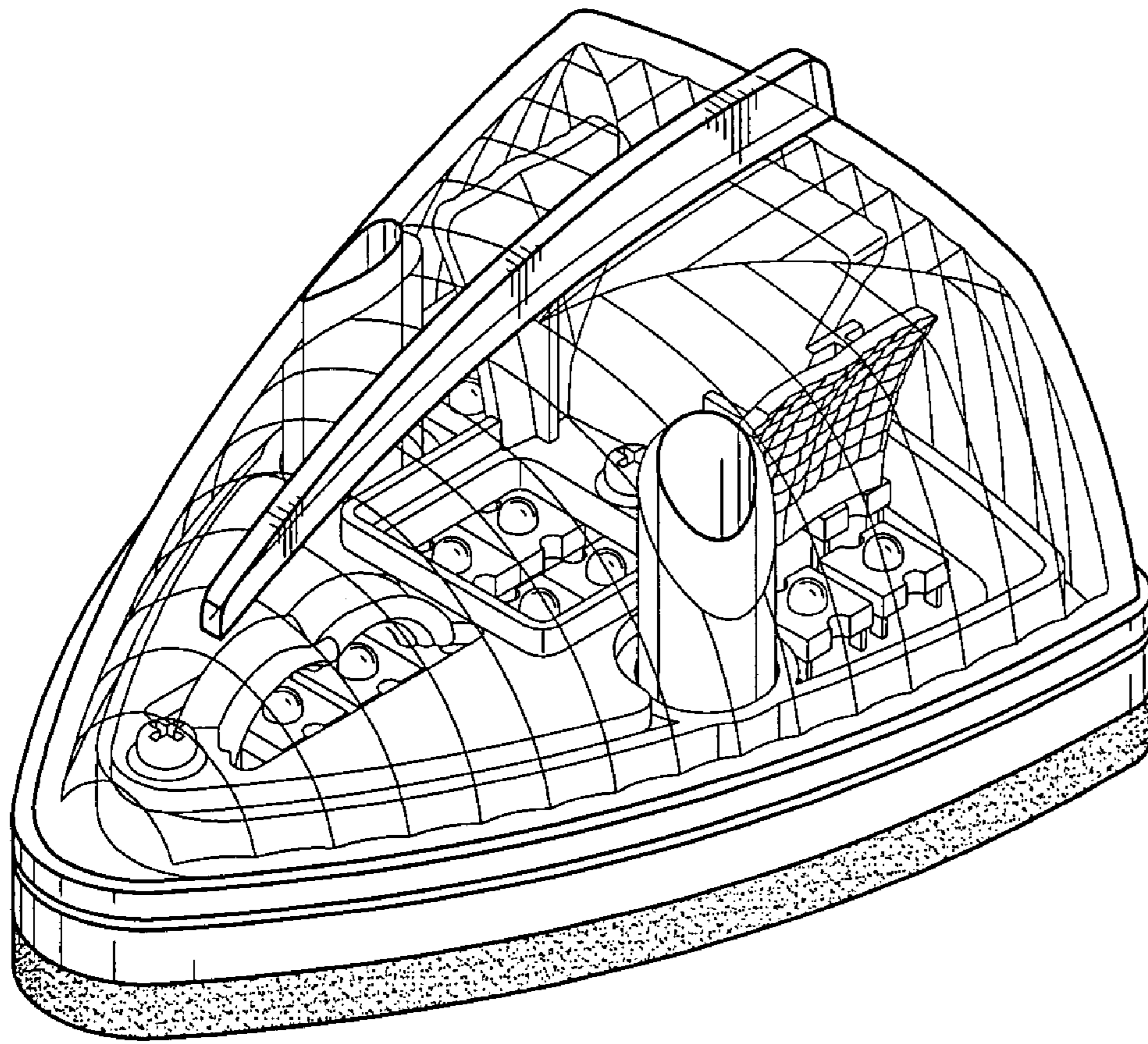

FIG. 1

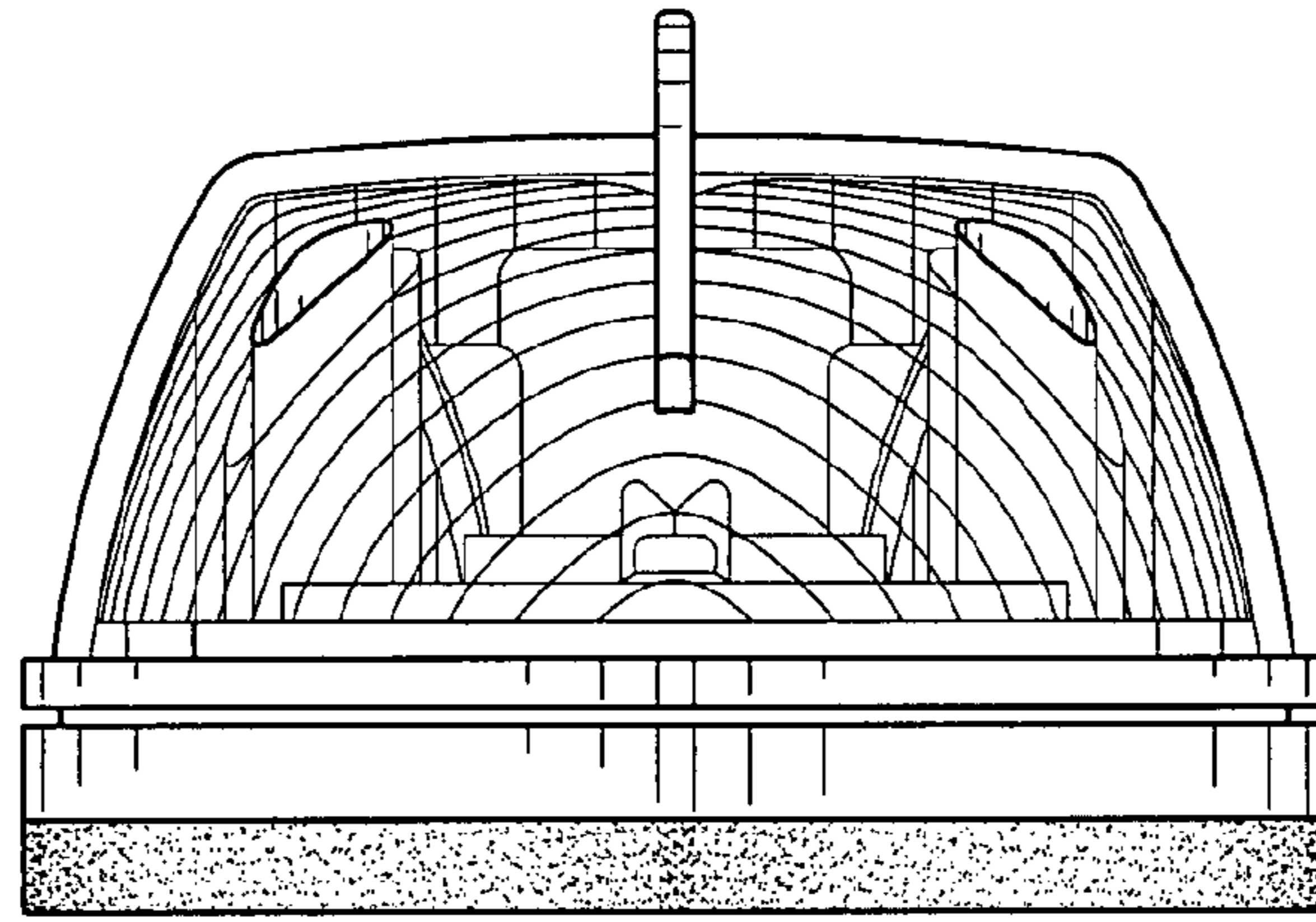

FIG. 2

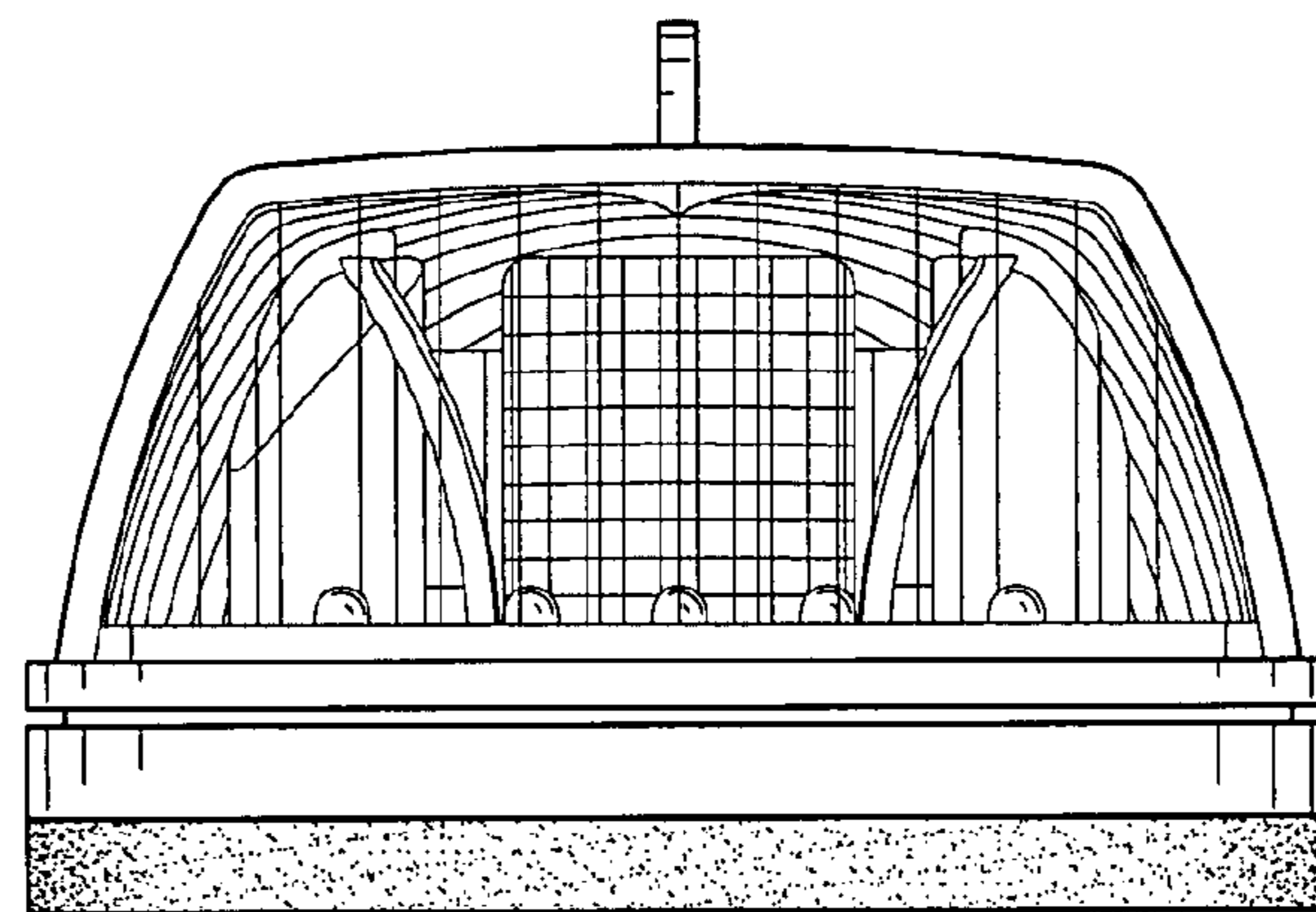

FIG. 3

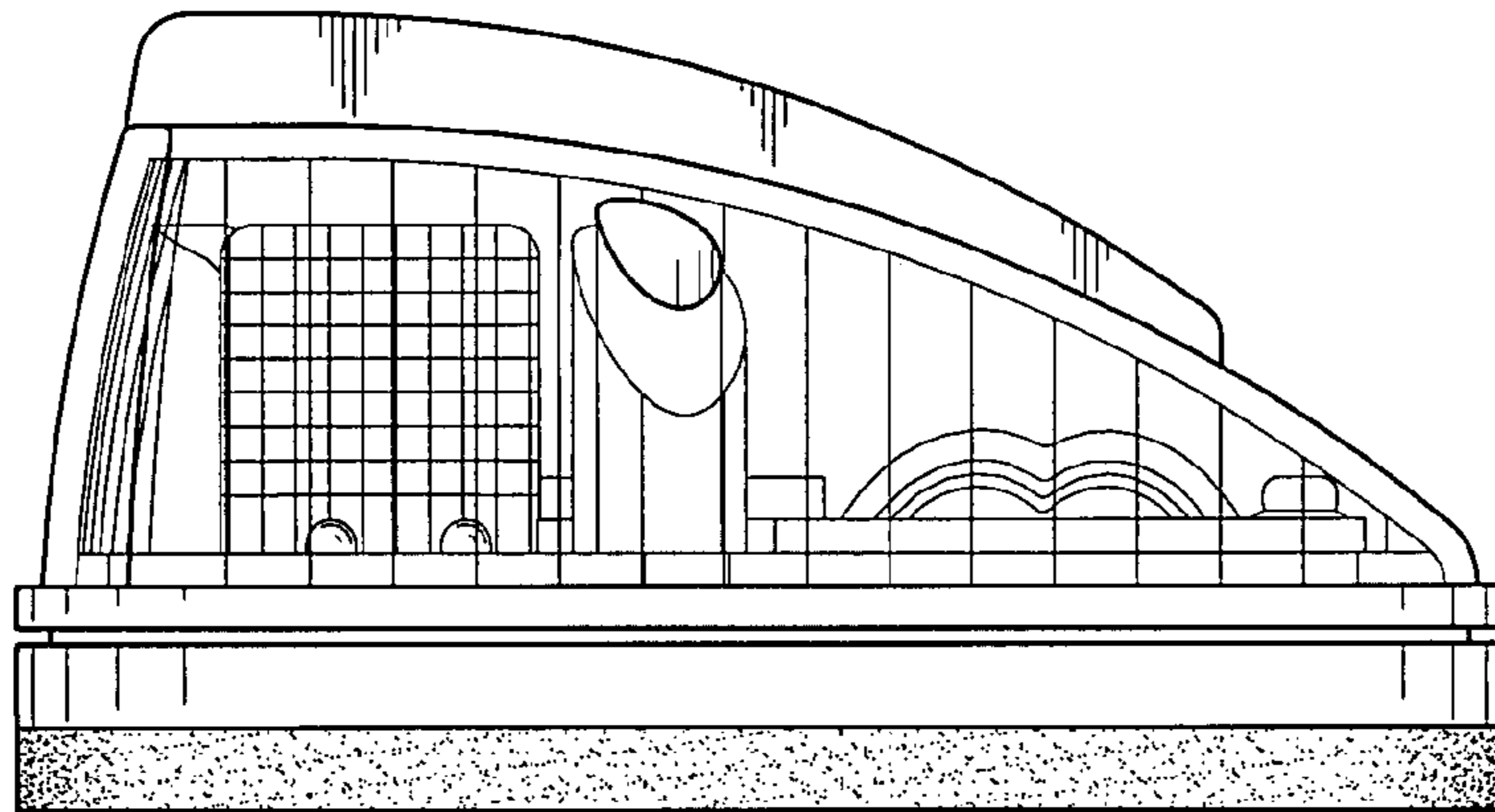

FIG. 4

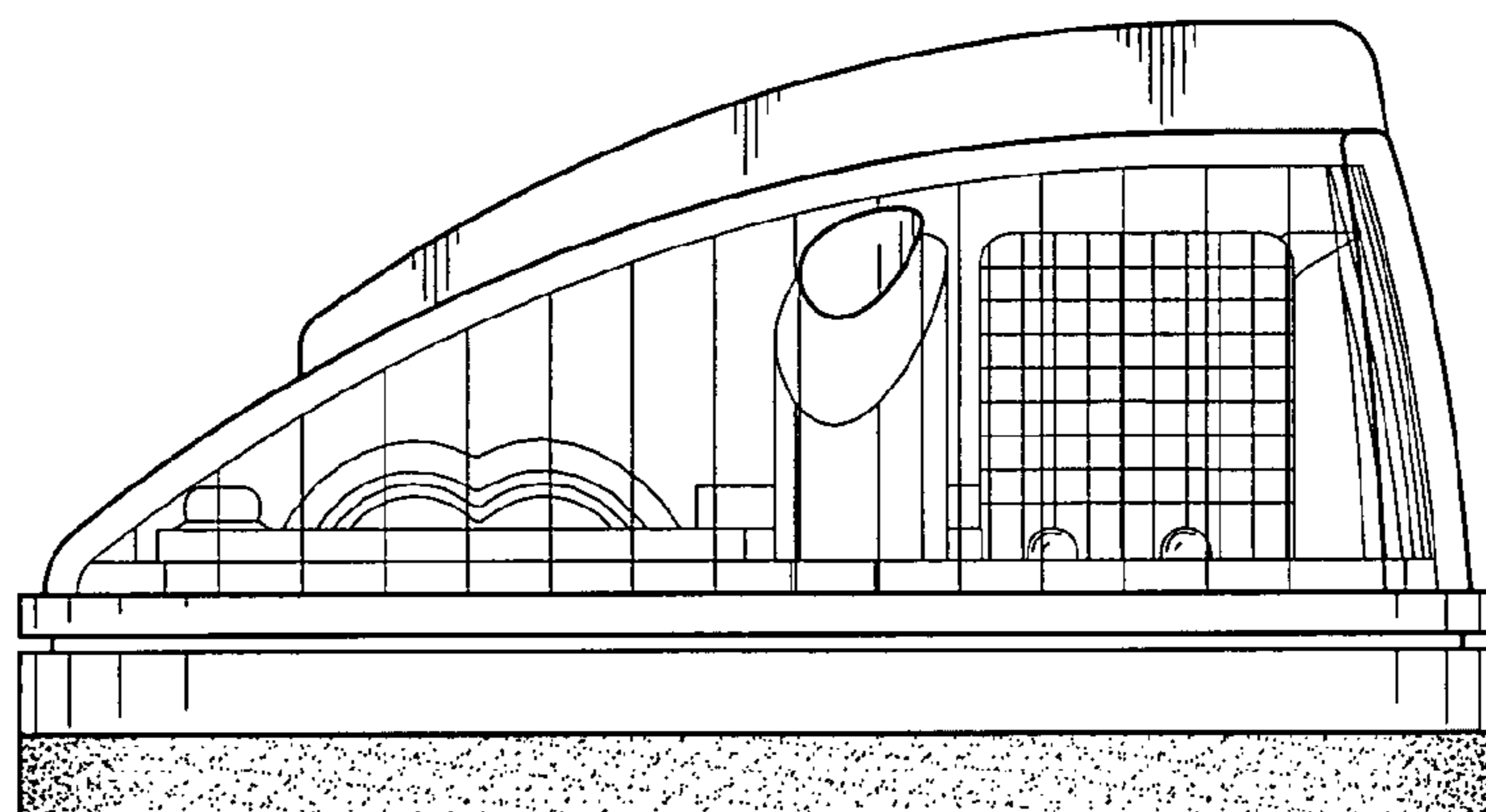

FIG. 5

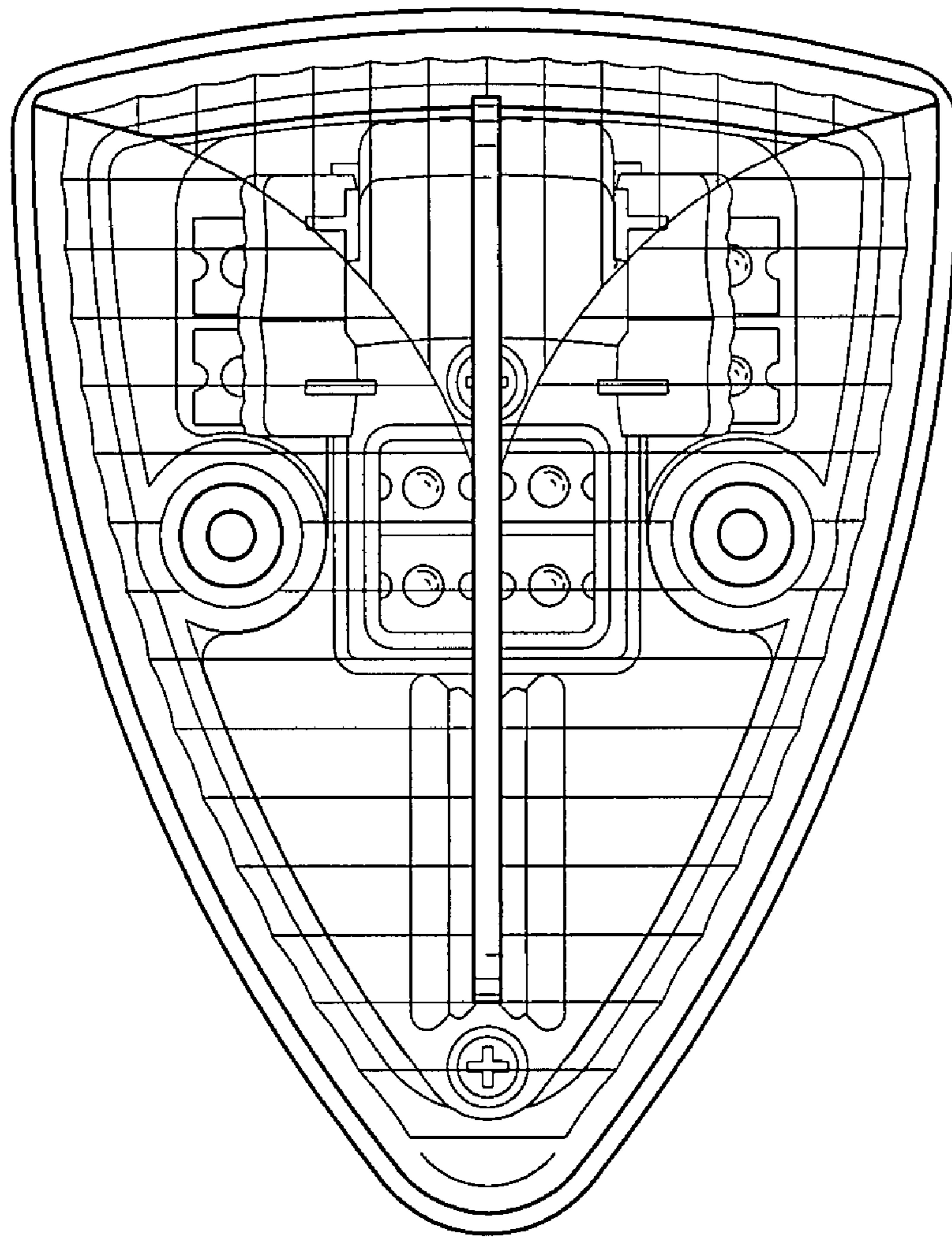

FIG.6

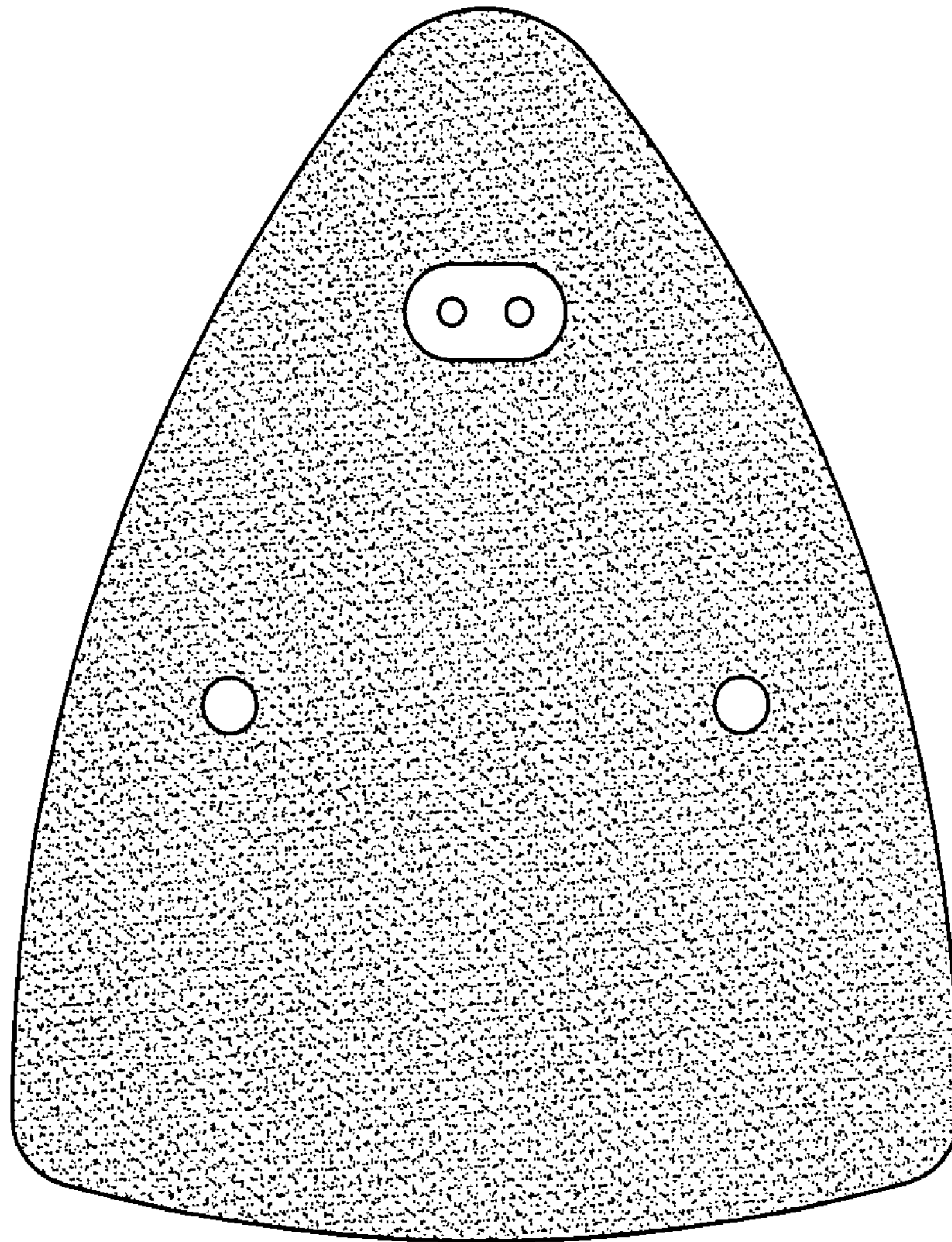

FIG.7