



US00D553600S

(12) **United States Design Patent**  
**Kim et al.**

(10) **Patent No.:** **US D553,600 S**  
(45) **Date of Patent:** **\*\* Oct. 23, 2007**

(54) **PORTABLE PHONE**

(75) Inventors: **Jin-Soo Kim**, Yongin-si (KR); **Nam-Mi Kim**, Seoul (KR); **Chang-Hwan Hwang**, Goyang-si (KR)

(73) Assignee: **Samsung Electronics Co., Ltd.**, Suwon-Si (KR)

(\*\*) Term: **14 Years**

(21) Appl. No.: **29/258,217**

(22) Filed: **Apr. 19, 2006**

(30) **Foreign Application Priority Data**

Oct. 28, 2005 (KR) ..... 30-2005-0036437

(51) **LOC (8) Cl.** ..... **14-03**

(52) **U.S. Cl.** ..... **D14/138**

(58) **Field of Classification Search** ..... D14/137,  
D14/138, 147, 218, 341-347, 496; 455/90.3,  
455/556.1, 556.2, 575.1, 575.3, 575.4; 379/433.01-433.13;  
361/814; 348/14.02

See application file for complete search history.

(56) **References Cited**

**U.S. PATENT DOCUMENTS**

D481,692	S *	11/2003	Husgafvel	.....	D14/138
D506,988	S *	7/2005	Oh	.....	D14/138
D508,473	S *	8/2005	Lee et al.	.....	D14/138
D508,688	S *	8/2005	Lee et al.	.....	D14/138
D512,702	S *	12/2005	Lee et al.	.....	D14/138
D526,297	S *	8/2006	Lee et al.	.....	D14/138
D527,367	S *	8/2006	Yun et al.	.....	D14/138
D527,369	S *	8/2006	Chung et al.	.....	D14/138
D527,716	S *	9/2006	Kim et al.	.....	D14/138
D528,092	S *	9/2006	Lee et al.	.....	D14/138
D528,533	S *	9/2006	Lee et al.	.....	D14/138
D529,014	S *	9/2006	Kim et al.	.....	D14/138
D529,475	S *	10/2006	Lee et al.	.....	D14/138
D529,888	S *	10/2006	Lee et al.	.....	D14/138
D529,891	S *	10/2006	Hyun et al.	.....	D14/138

D535,272	S *	1/2007	Kim et al.	.....	D14/138
D535,305	S *	1/2007	Lee	.....	D14/496
D535,966	S *	1/2007	Lee et al.	.....	D14/138
2005/0095995	A1 *	5/2005	Bae	.....	455/90.3
2005/0107126	A1 *	5/2005	Kim	.....	455/565
2005/0124394	A1 *	6/2005	Kim et al.	.....	455/575.3
2005/0146600	A1 *	7/2005	Chipchase et al.	.....	348/14.02
2005/0176479	A1 *	8/2005	Bae et al.	.....	455/575.4
2005/0197173	A1 *	9/2005	Wee et al.	.....	455/575.4
2007/0021160	A1 *	1/2007	Li	.....	455/575.4
2007/0071232	A1 *	3/2007	Chung	.....	379/433.07

**OTHER PUBLICATIONS**

Eten G500, announced 1<sup>st</sup> quarter 2006, [online], [retrieved on Feb. 20, 2007]. Retrieved from Internet ,<URL: <http://www.gsmarena.com>>.\*

(Continued)

*Primary Examiner*—Jeffrey Asch

*Assistant Examiner*—Bridget L. Eland

(74) *Attorney, Agent, or Firm*—Staas & Halsey LLP

(57) **CLAIM**

The ornamental design for the portable phone, as shown and described.

**DESCRIPTION**

FIG. 1 is a perspective view of the portable phone showing our design;

FIG. 2 is a front view thereof;

FIG. 3 is a rear view thereof;

FIG. 4 is a left side view thereof;

FIG. 5 is a right side view thereof;

FIG. 6 is a top plan view thereof;

FIG. 7 is a bottom plan view thereof;

FIG. 8 is a front, open view thereof;

FIG. 9 is a rear, open view thereof; and,

FIG. 10 is a right side, open view thereof.

**1 Claim, 9 Drawing Sheets**

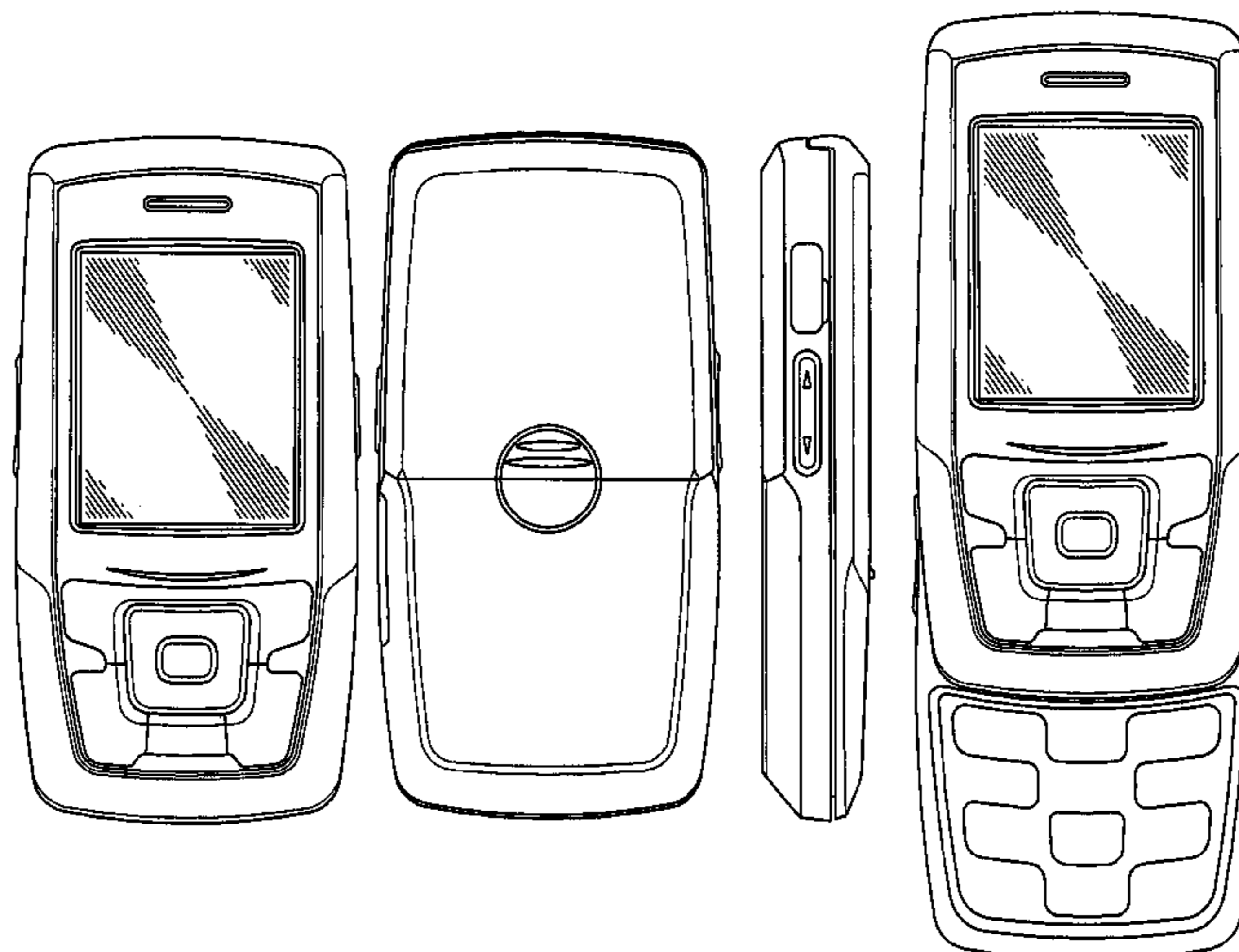

OTHER PUBLICATIONS

VK Mobile VK4500, announced 4<sup>th</sup> quarter 2005, [online], [retrieved on Feb. 20, 2007]. Retrieved from Internet ,<URL: <http://www.gsmarena.com>>.\*

Sagem MY Z-55, announced 1<sup>st</sup> quarter 2005, [online], [retrieved on Feb. 20, 2007]. Retrieved from Internet ,<URL: <http://www.gsmarena.com>>.\*

LG KE260, announced Nov. 2006, [online], [retrieved on Feb. 20, 2007]. Retrieved from Internet ,<URL: <http://www.gsmarena.com>>.\*

InnoStream INNO P10, announced Jun. 2005, [online], [retrieved on Feb. 20, 2007]. Retrieved from Internet ,<URL: <http://www.gsmarena.com>>.\*

\* cited by examiner

FIG. 1

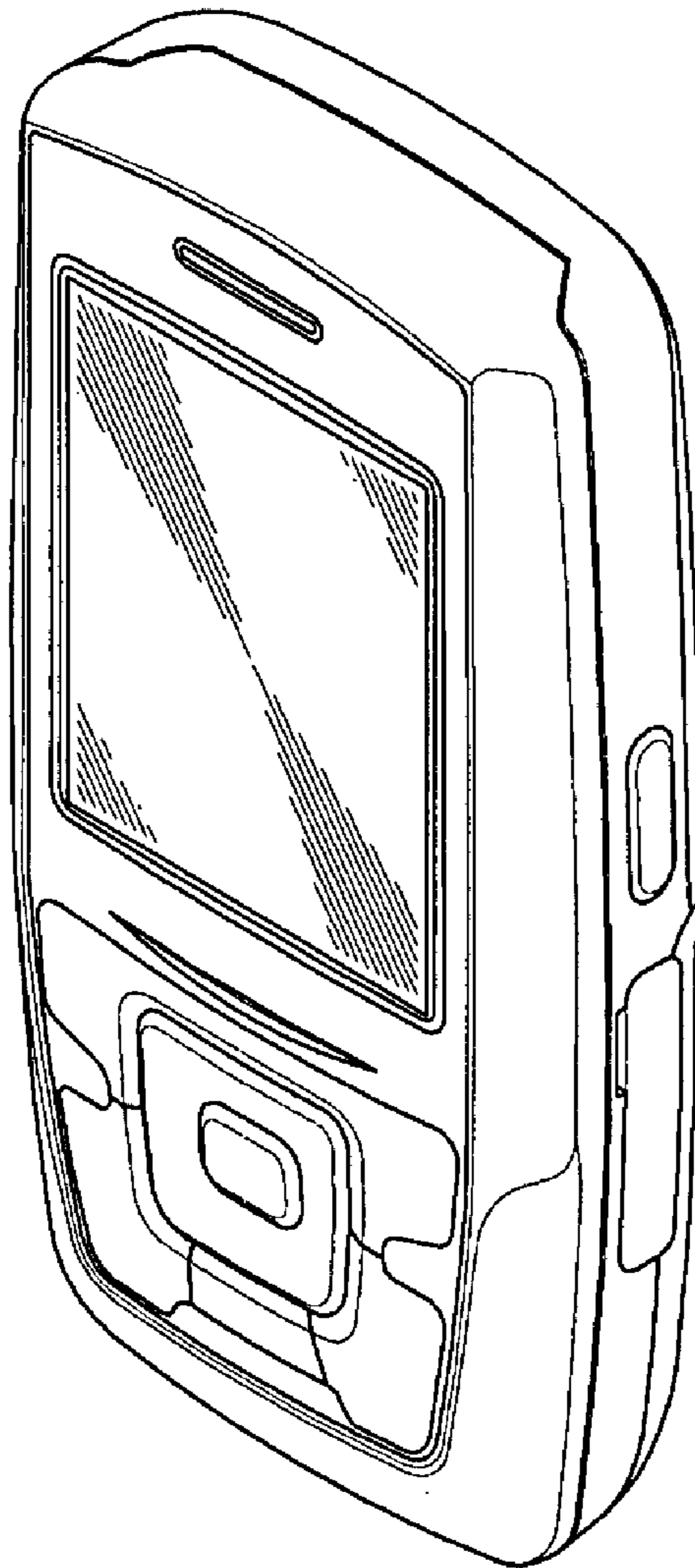

FIG. 2

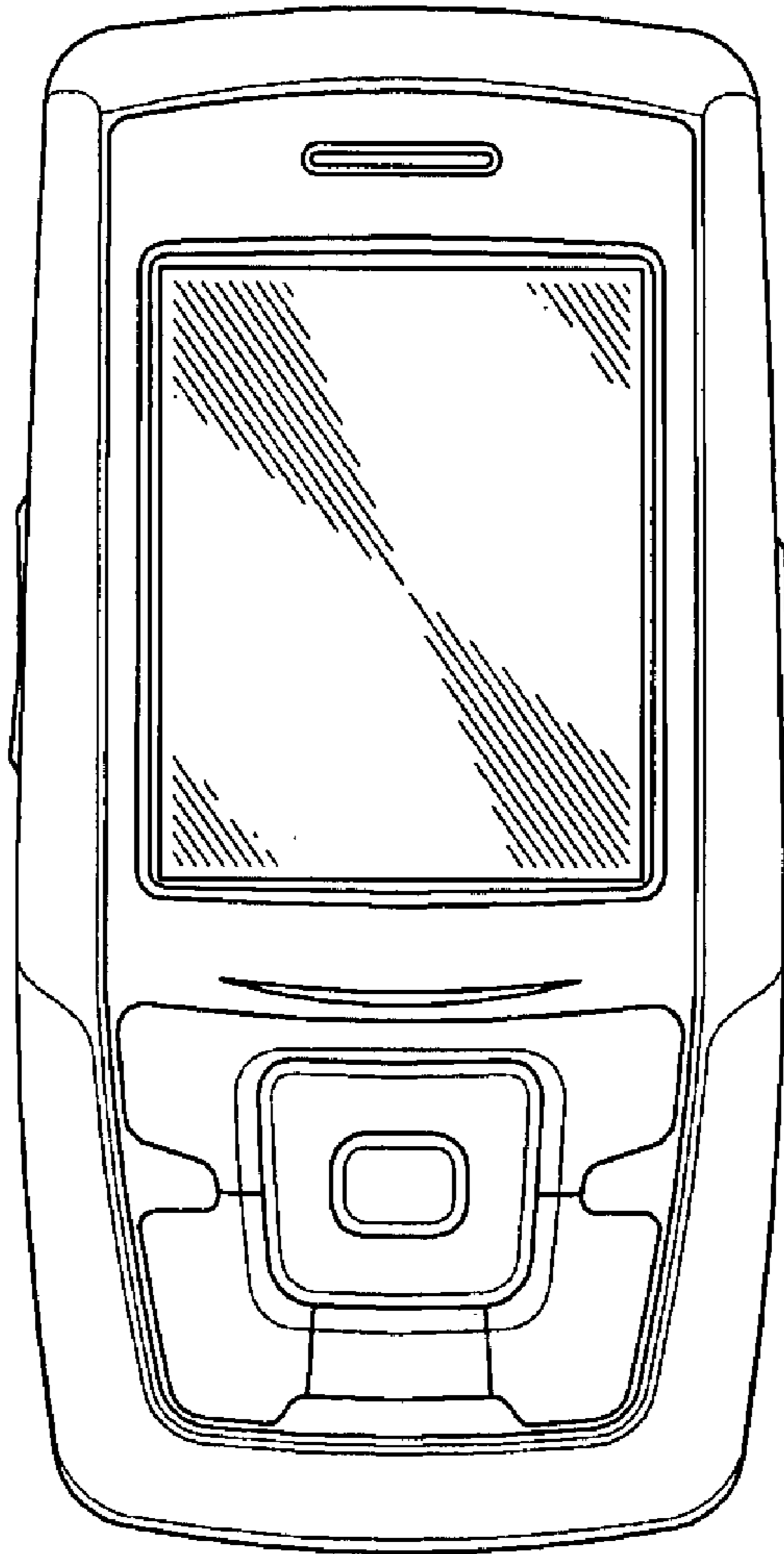

FIG. 3

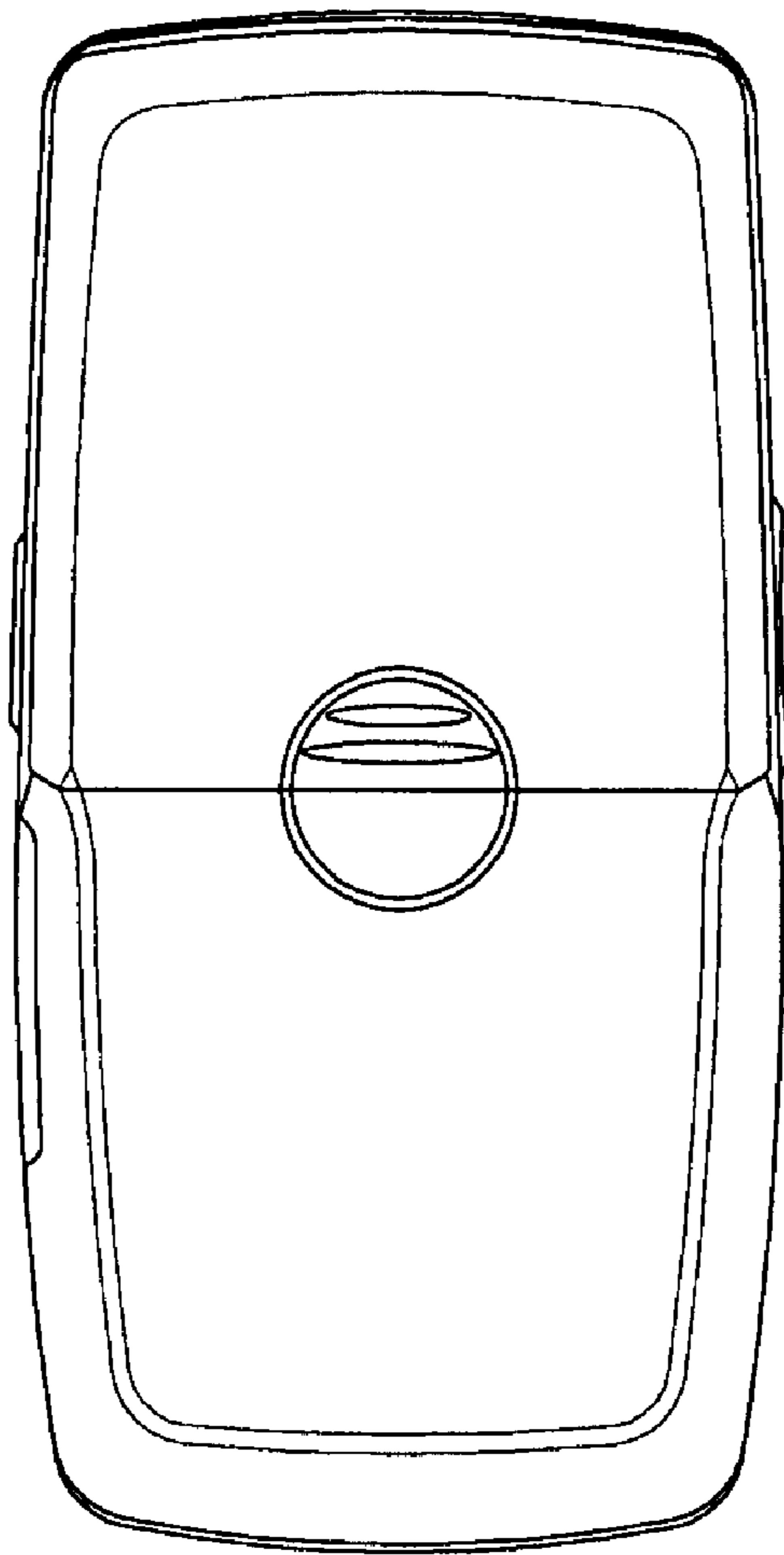

FIG. 4

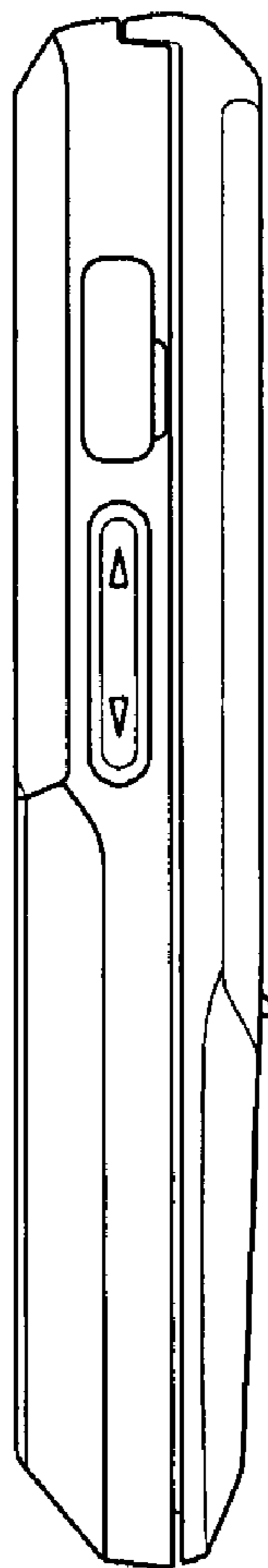

FIG. 5

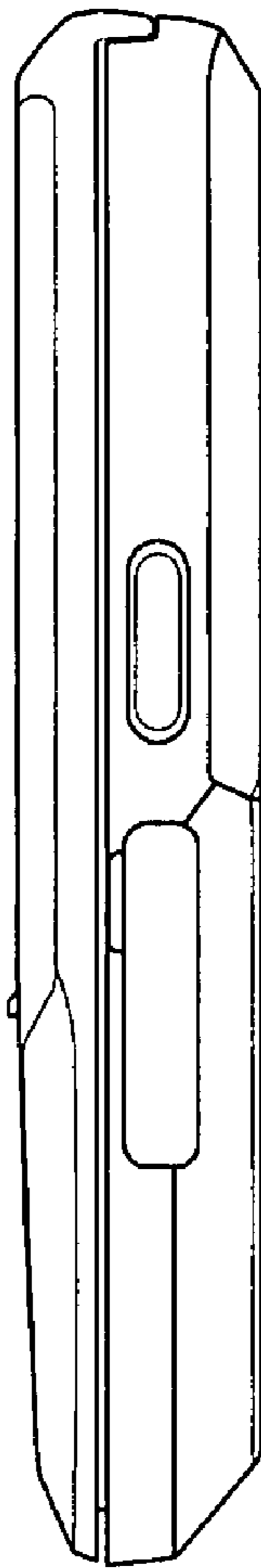

FIG. 6

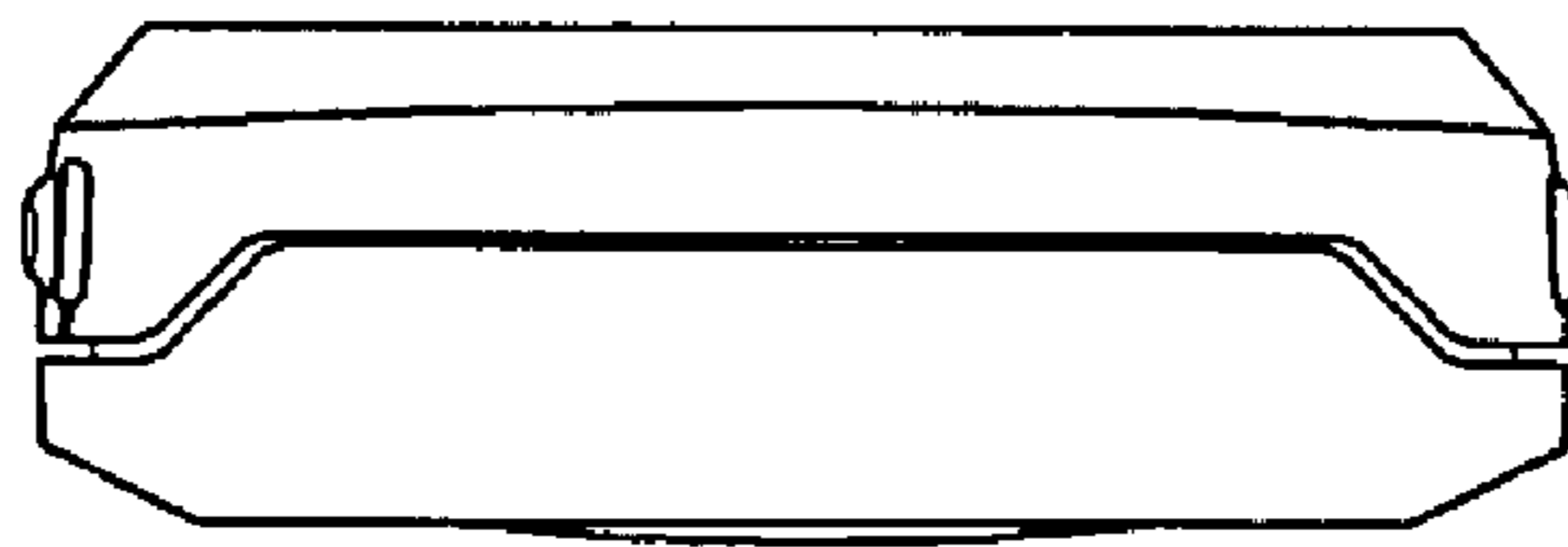

FIG. 7

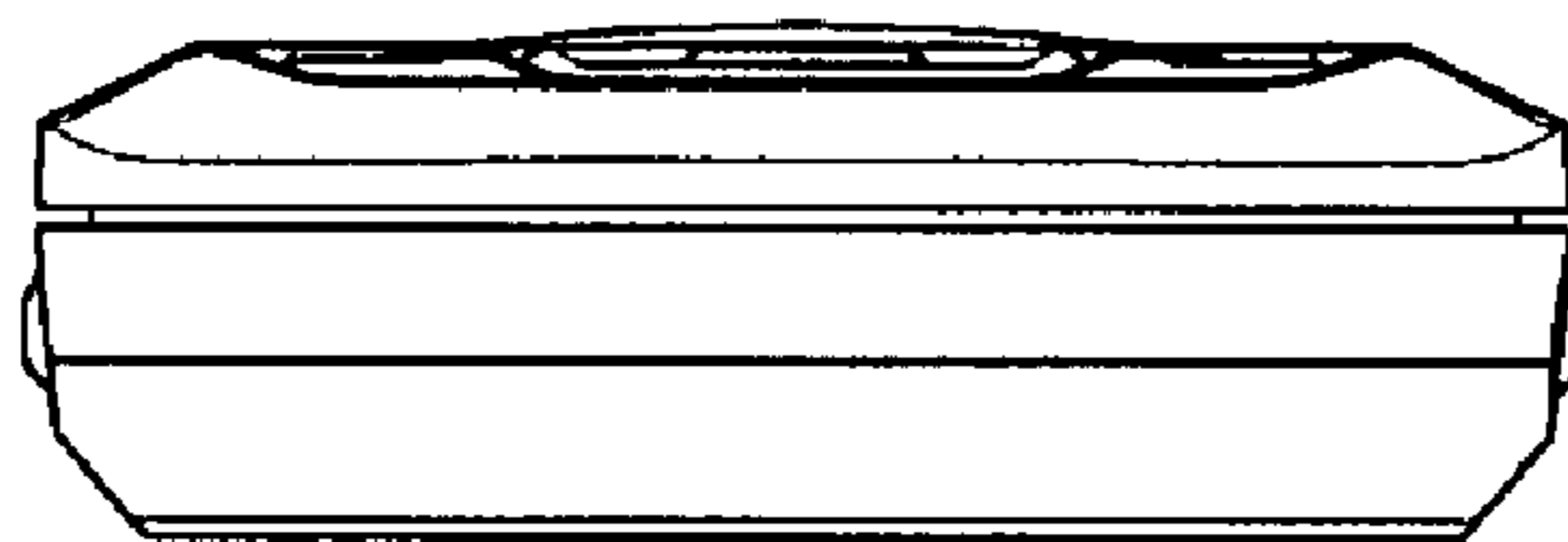



FIG. 8

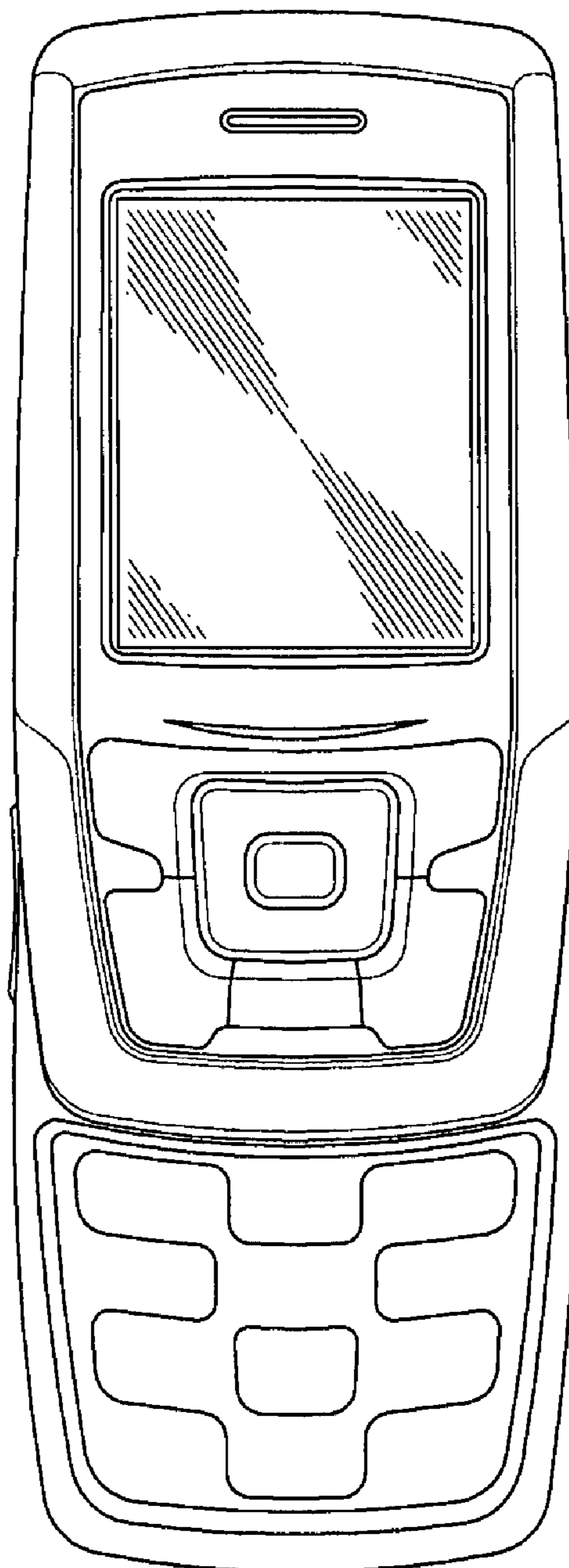

FIG. 9

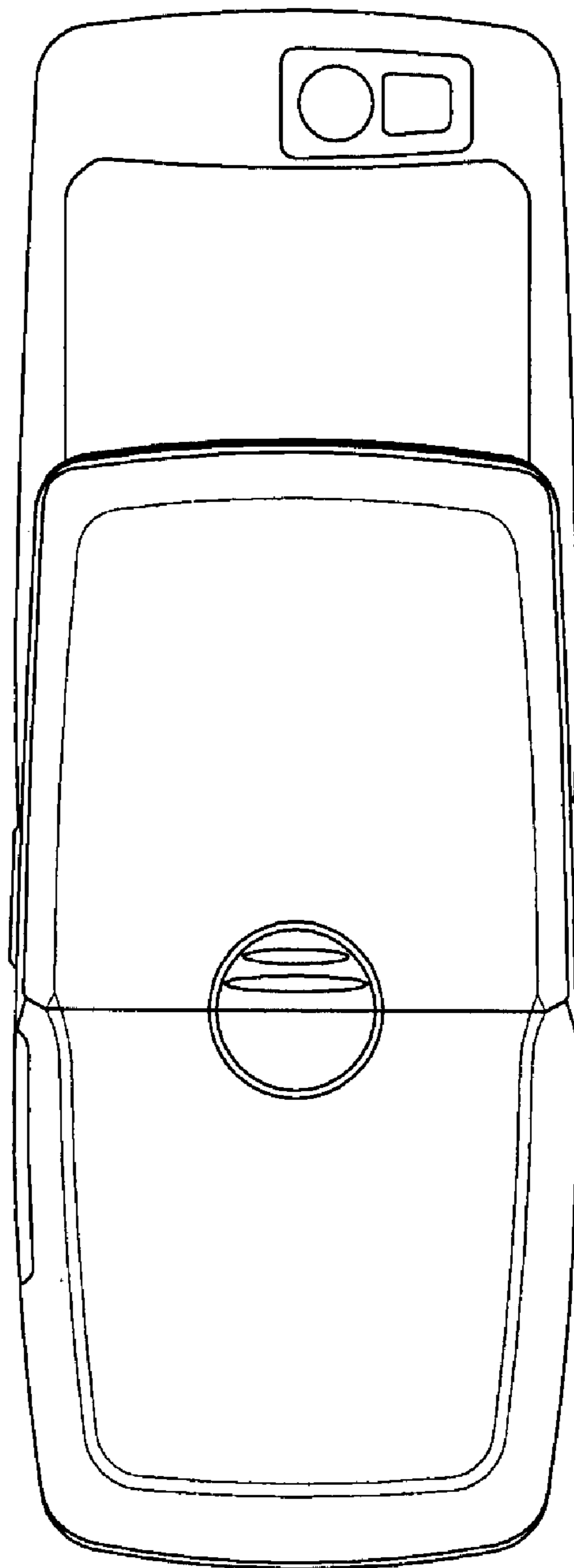

FIG. 10

