



US00D553596S

(12) **United States Design Patent**
Kim et al.

(10) **Patent No.:** **US D553,596 S**

(45) **Date of Patent:** **** Oct. 23, 2007**

(54) **MOBILE PHONE**

(75) Inventors: **Young-Sae Kim**, Los Altos, CA (US);
Chi-Young Ahn, Seoul (KR);
Young-Ju Yeo, Seoul (KR);
Chang-Hwan Hwang, Goyang-si (KR)

(73) Assignee: **Samsung Electronics Co., Ltd.**,
Suwon-Si (KR)

(**) Term: **14 Years**

(21) Appl. No.: **29/243,535**

(22) Filed: **Nov. 28, 2005**

(30) **Foreign Application Priority Data**

Jun. 27, 2005 (KR) 30-2005-0021406

(51) **LOC (8) Cl.** **14-03**

(52) **U.S. Cl.** **D14/138**

(58) **Field of Classification Search** D14/137,
D14/138, 147, 218, 341-347, 496; 455/90.3,
455/556.1, 556.2, 575.1, 575.3, 575.4; 379/433.01-433.13;
361/814; 348/14.02

See application file for complete search history.

(56) **References Cited**

U.S. PATENT DOCUMENTS

D479,214 S *	9/2003	Bertrand et al.	D14/138
D479,215 S *	9/2003	Yokoyama	D14/138
D509,203 S *	9/2005	Bertrand et al.	D14/138
D509,215 S *	9/2005	Han et al.	D14/343
D517,038 S *	3/2006	Lee et al.	D14/138
D519,998 S *	5/2006	Park	D14/346
D525,226 S *	7/2006	Jang	D14/138
D525,608 S *	7/2006	Ryu	D14/138
D525,610 S *	7/2006	Kim et al.	D14/138
D526,302 S *	8/2006	Kim	D14/138
D527,364 S *	8/2006	Lee et al.	D14/138
D530,295 S *	10/2006	Chung et al.	D14/138
D530,297 S *	10/2006	Moon et al.	D14/138

D531,607 S *	11/2006	Kim et al.	D14/138
D531,609 S *	11/2006	Kim et al.	D14/138
D531,610 S *	11/2006	Kim et al.	D14/138
D531,976 S *	11/2006	Kim et al.	D14/138
D532,766 S *	11/2006	Lee	D14/138
D535,275 S *	1/2007	Kim et al.	D14/138
D536,691 S *	2/2007	Park	D14/138
2004/0266477 A1 *	12/2004	Murata	455/556.1
2005/0090298 A1 *	4/2005	Park et al.	455/575.4
2005/0233708 A1 *	10/2005	Im et al.	455/90.3
2006/0098813 A1 *	5/2006	Takamori et al.	379/433.13
2006/0205450 A1 *	9/2006	Amano et al.	455/575.4
2007/0004477 A1 *	1/2007	Kim	455/575.4

OTHER PUBLICATIONS

Samsung i750, announced 1st quarter 2005, [online], [retrieved on Feb. 8, 2007]. Retrieved from Internet ,<URL: <http://www.gsmarena.com>>.*

(Continued)

Primary Examiner—Jeffrey Asch

Assistant Examiner—Bridget L Eland

(74) *Attorney, Agent, or Firm*—Staas & Halsey LLP

(57)

CLAIM

The ornamental design for the mobile phone, as shown and described.

DESCRIPTION

FIG. 1 is a perspective view of the mobile phone showing our design;

FIG. 2 is a front view thereof;

FIG. 3 is a rear view thereof;

FIG. 4 is a left side view thereof;

FIG. 5 is a right side view thereof;

FIG. 6 is a top plan view thereof; and

FIG. 7 is a bottom plan view thereof; and,

FIG. 8 is a perspective, open view, thereof.

1 Claim, 4 Drawing Sheets

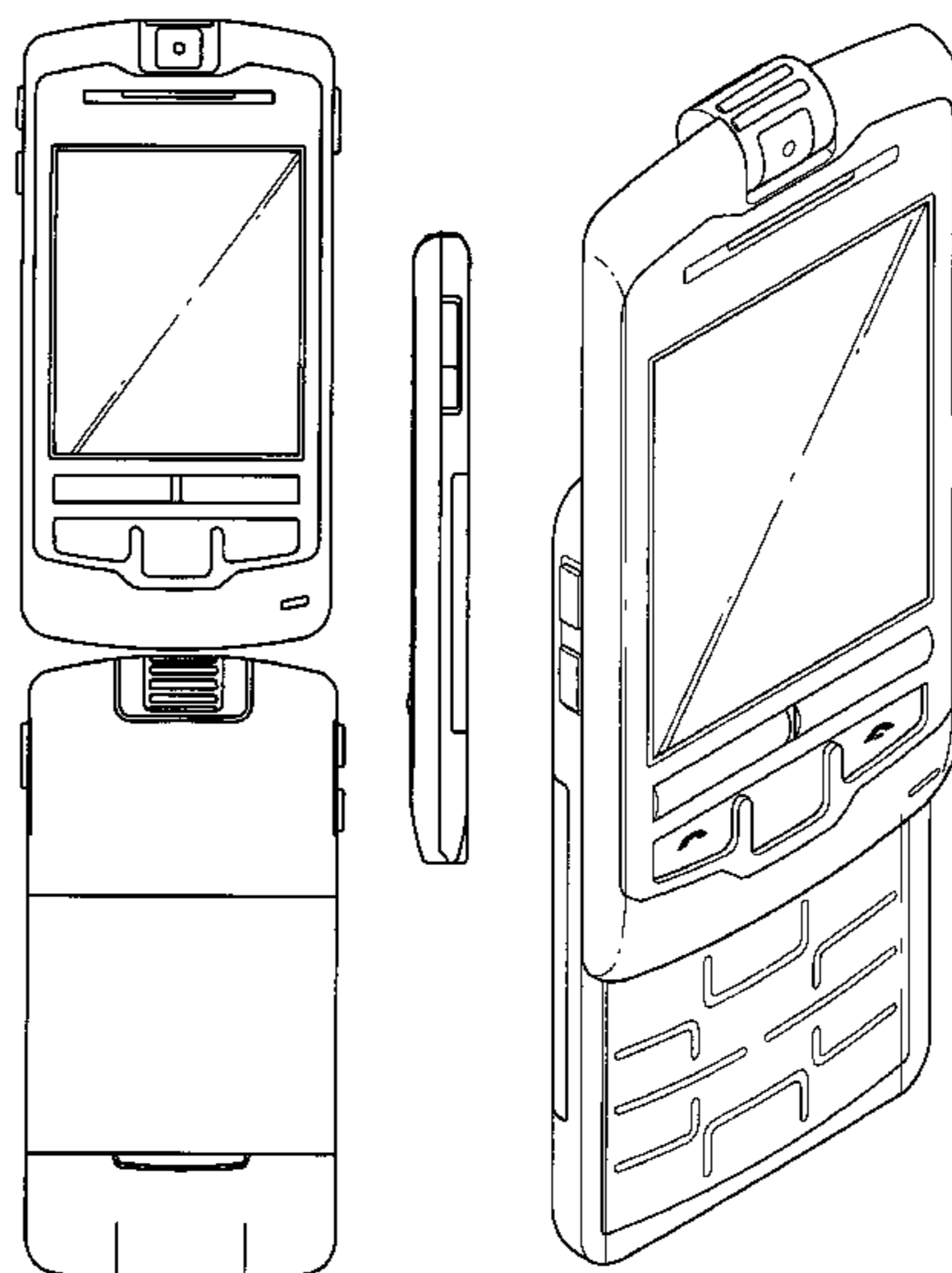

OTHER PUBLICATIONS

i-mate K-JAM, announced Sep. 2005, [online], [retrieved on Feb. 20, 2007]. Retrieved from Internet ,<URL: <http://www.gsmarena.com>>.*

BenQ-Siemens CL71, announced Mar. 2006, [online], [retrieved on Feb. 16, 2007]. Retrieved from Internet ,<URL: <http://www.gsmarena.com>>.*

Eten G500, announced 1st quarter 2006, [online], [retrieved on Feb. 20, 2007]. Retrieved from Internet ,<URL: <http://www.gsmarena.com>>.*

Alcatel OT-C717, announced Feb. 2007, [online], [retrieved on Feb. 16, 2007]. Retrieved from Internet ,<URL: <http://www.gsmarena.com>>.*

* cited by examiner

FIG. 1

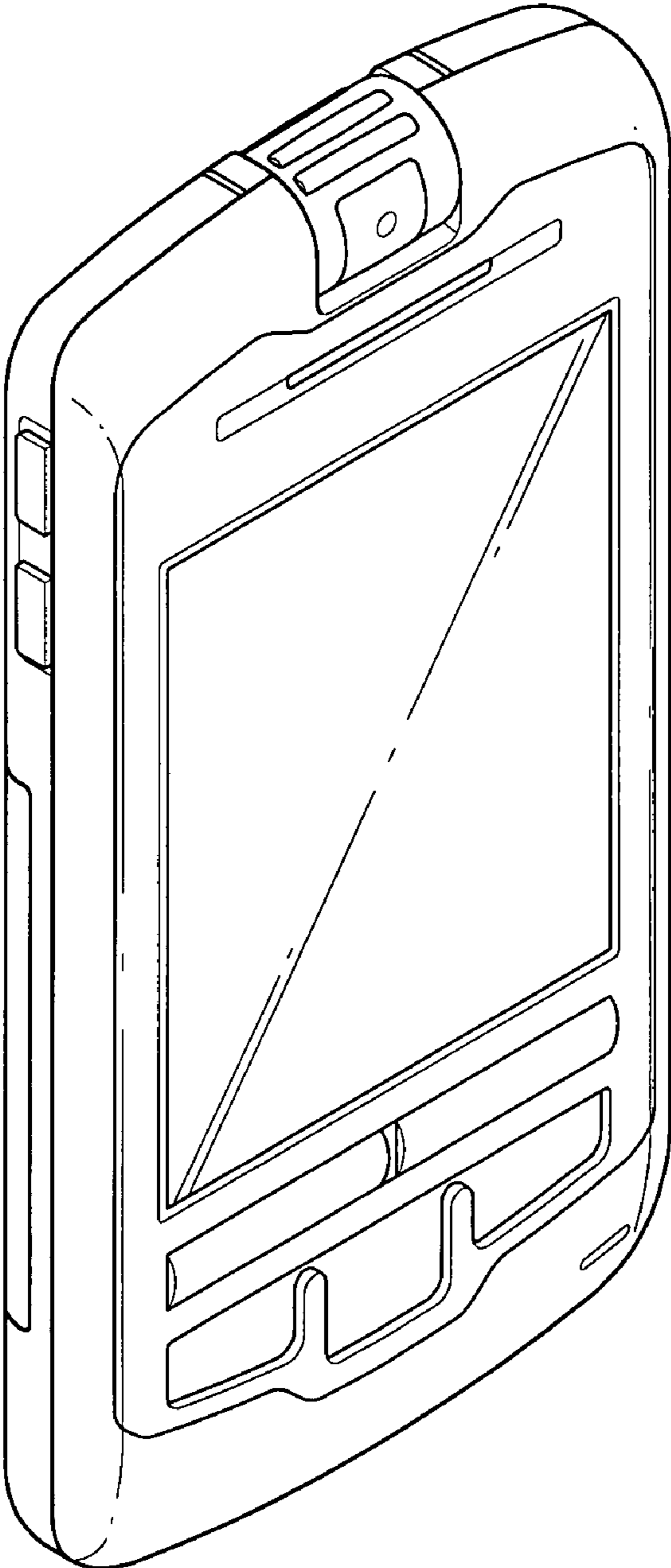

FIG. 2

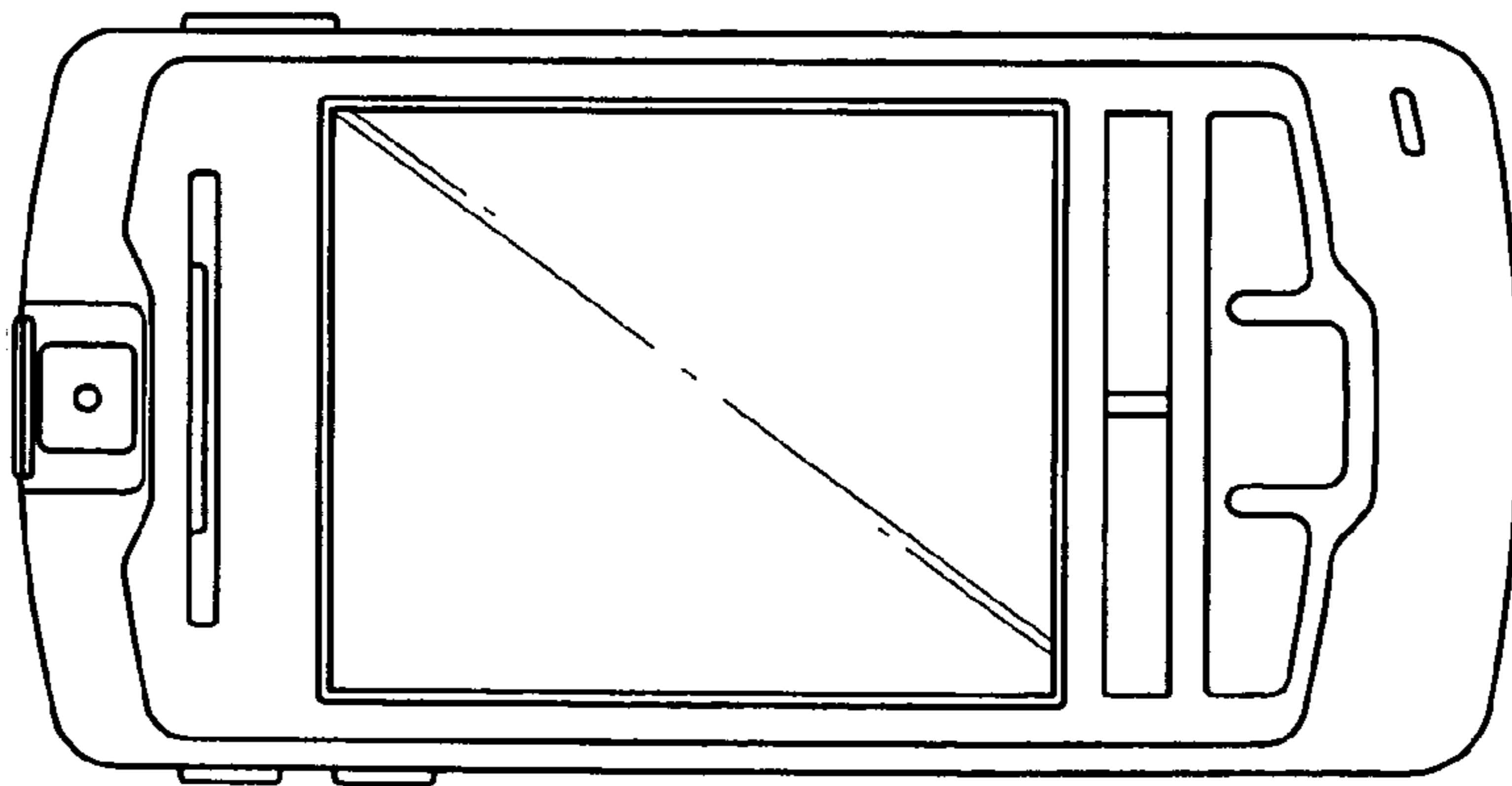

FIG. 3

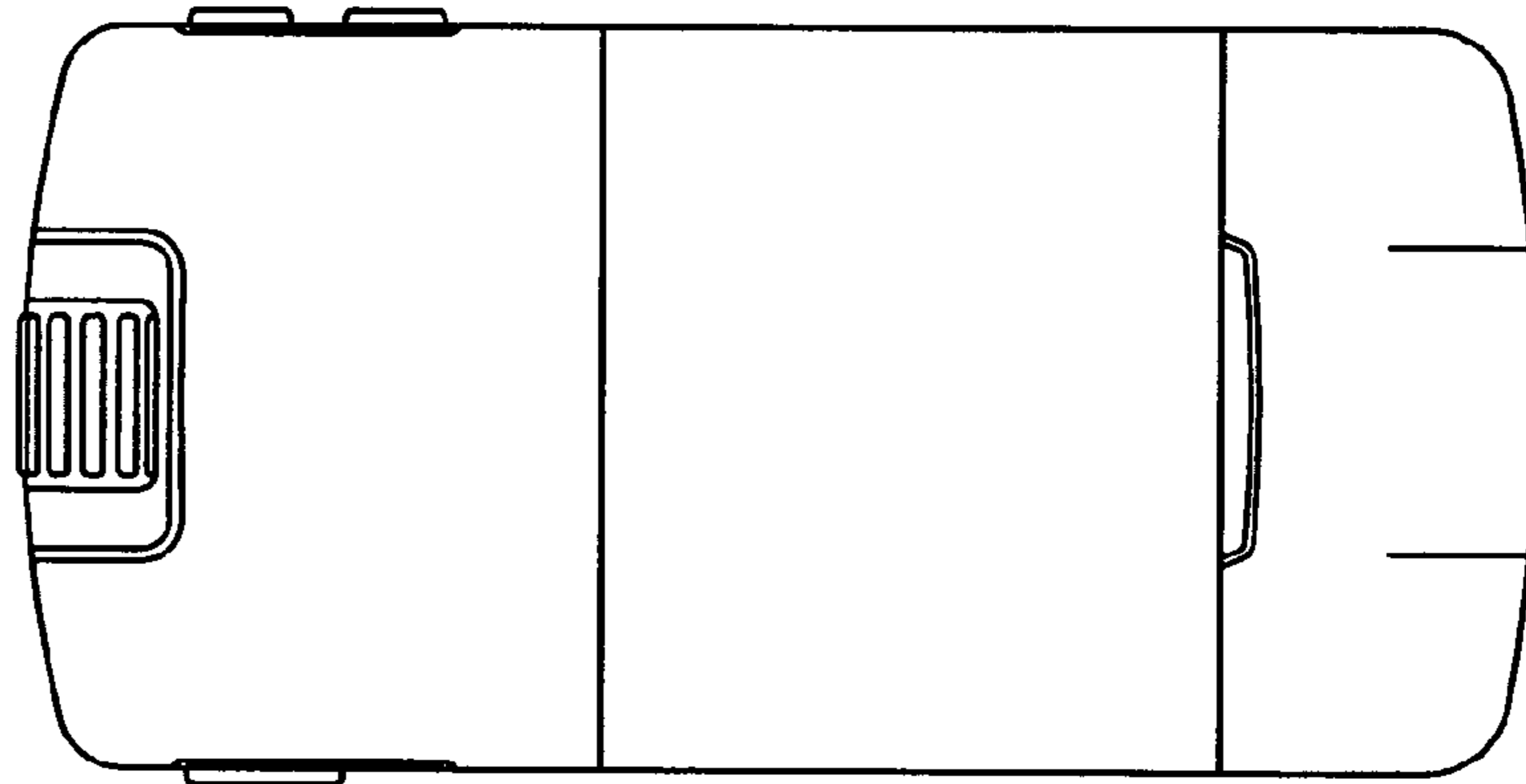

FIG. 4

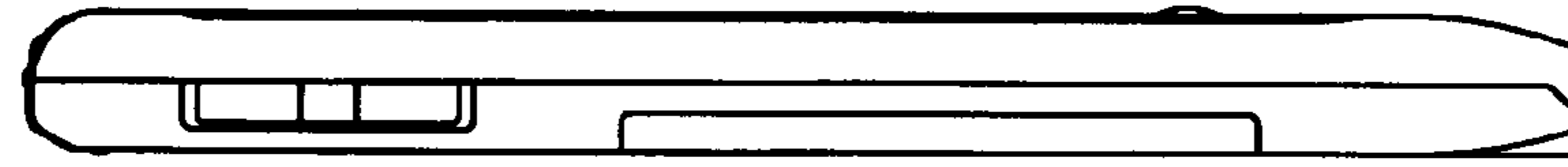

FIG. 5

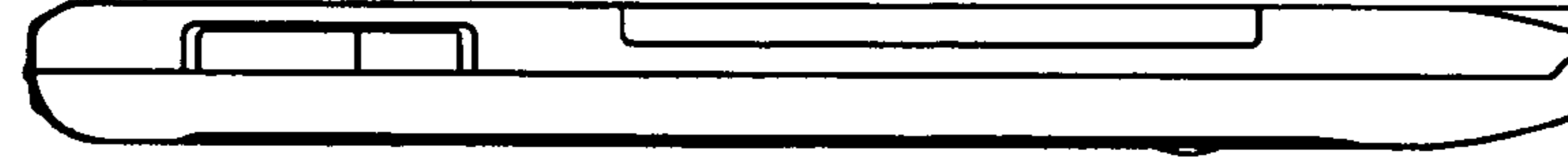

FIG. 6

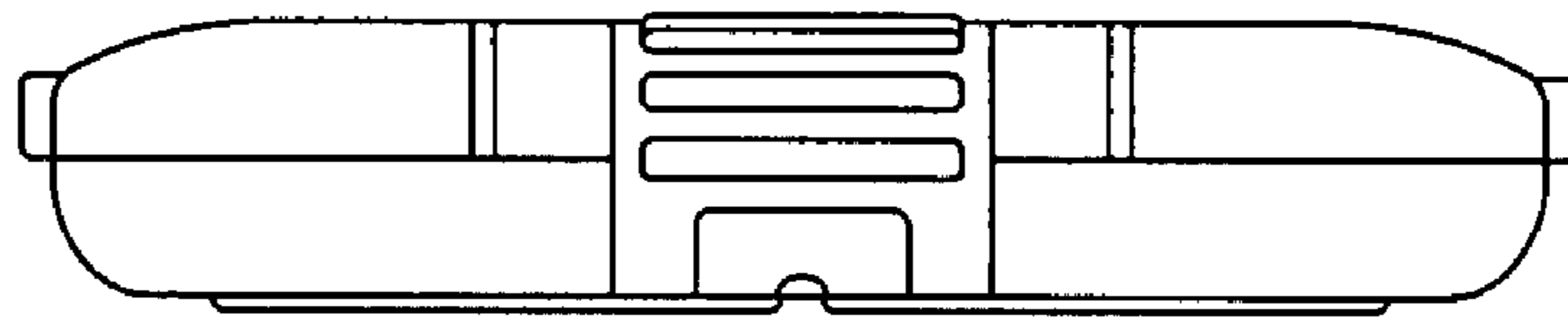

FIG. 7

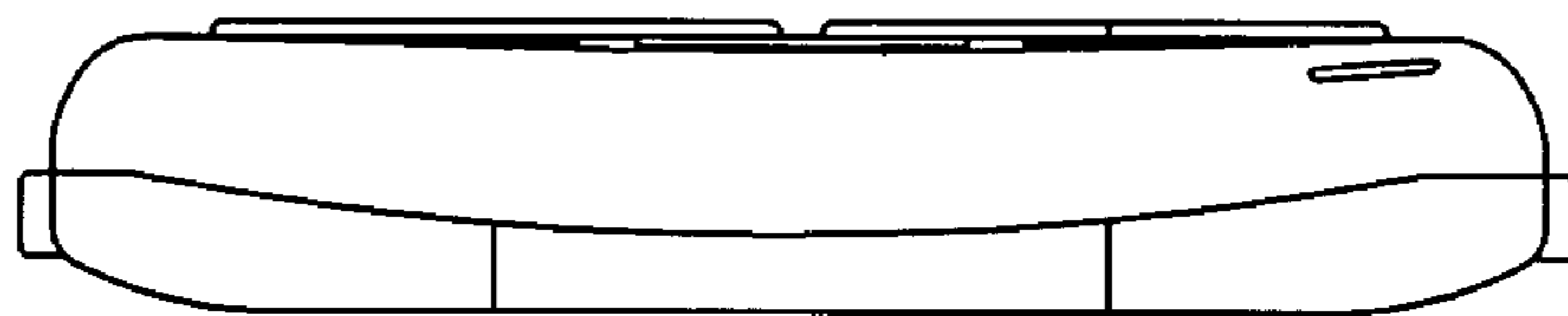

FIG. 8

