



US00D553573S

(12) **United States Design Patent**
Kondas

(10) **Patent No.:** **US D553,573 S**

(45) **Date of Patent:** **** Oct. 23, 2007**

(54) **LOW PROFILE ELECTRICAL TERMINAL**

D516,522 S * 3/2006 Kondas D13/154
D516,523 S * 3/2006 Kondas D13/154

(75) Inventor: **Shawn J. Kondas**, Kendallville, IN
(US)

* cited by examiner

(73) Assignee: **Pent Technologies, Inc.**, Kendallville,
IN (US)

Primary Examiner—Daniel Bui
(74) *Attorney, Agent, or Firm*—Taylor & Aust, P.C.

(**) Term: **14 Years**

(57) **CLAIM**

(21) Appl. No.: **29/245,814**

The ornamental design for a low profile electrical terminal,
as shown and described.

(22) Filed: **Dec. 29, 2005**

DESCRIPTION

(51) **LOC (8) Cl.** **13-03**

(52) **U.S. Cl.** **D13/149; D13/133**

(58) **Field of Classification Search** D13/133,
D13/146, 148, 149, 154, 184, 199; 439/650,
439/845, 849-850, 907

See application file for complete search history.

FIG. 1 is a perspective view of a low profile electrical
terminal showing my new design;

FIG. 2 is a side elevation view thereof;

FIG. 3 is an opposite side elevation view thereof;

FIG. 4 is an end elevation view thereof;

FIG. 5 is an opposite end elevation view thereof;

FIG. 6 is a top plan view thereof; and,

FIG. 7 is a bottom plan view thereof.

(56) **References Cited**

U.S. PATENT DOCUMENTS

4,699,445 A * 10/1987 Porta et al. 439/698
D478,315 S * 8/2003 Kondas D13/146
D486,790 S * 2/2004 Kondas D13/133

1 Claim, 2 Drawing Sheets

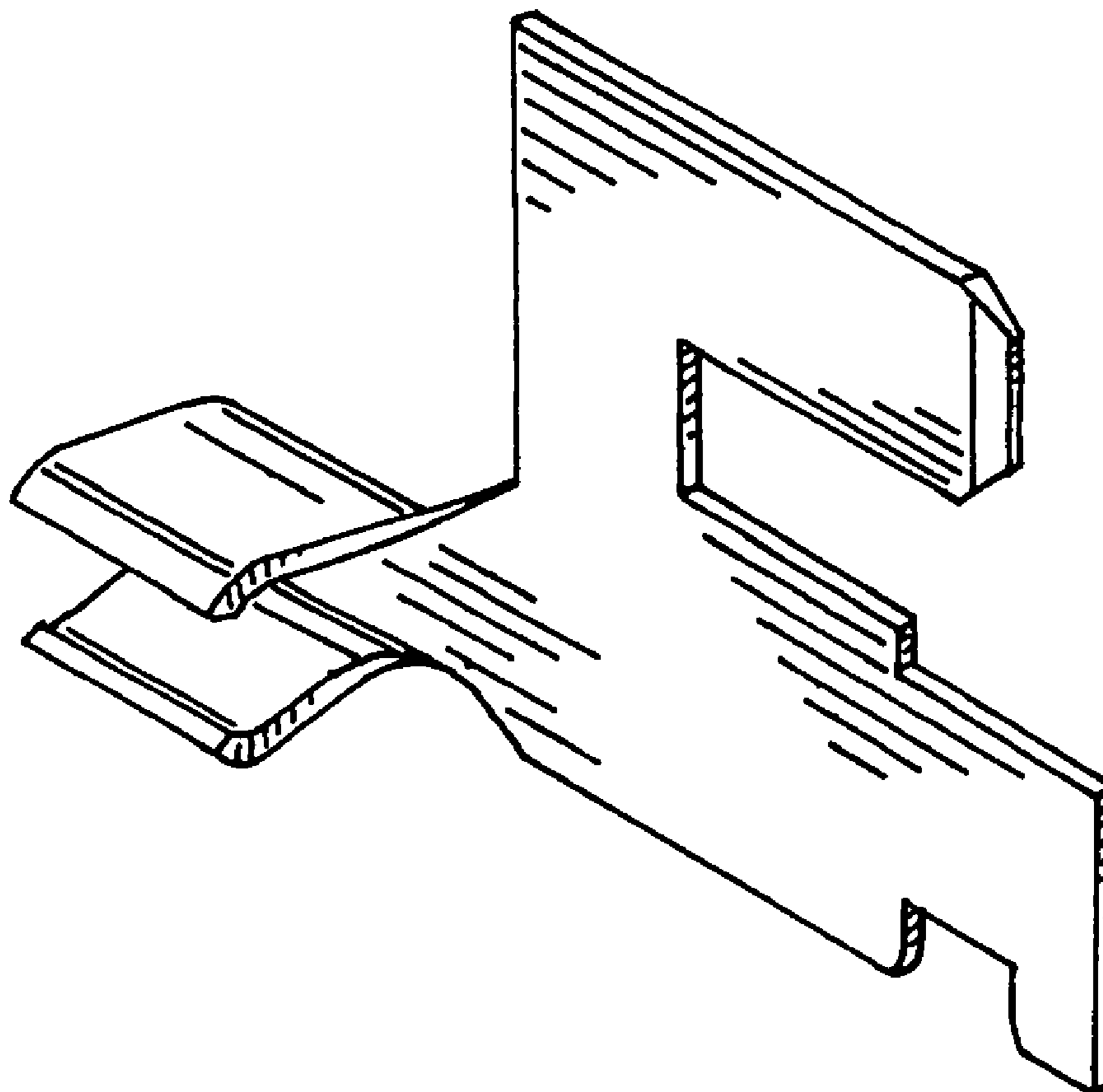

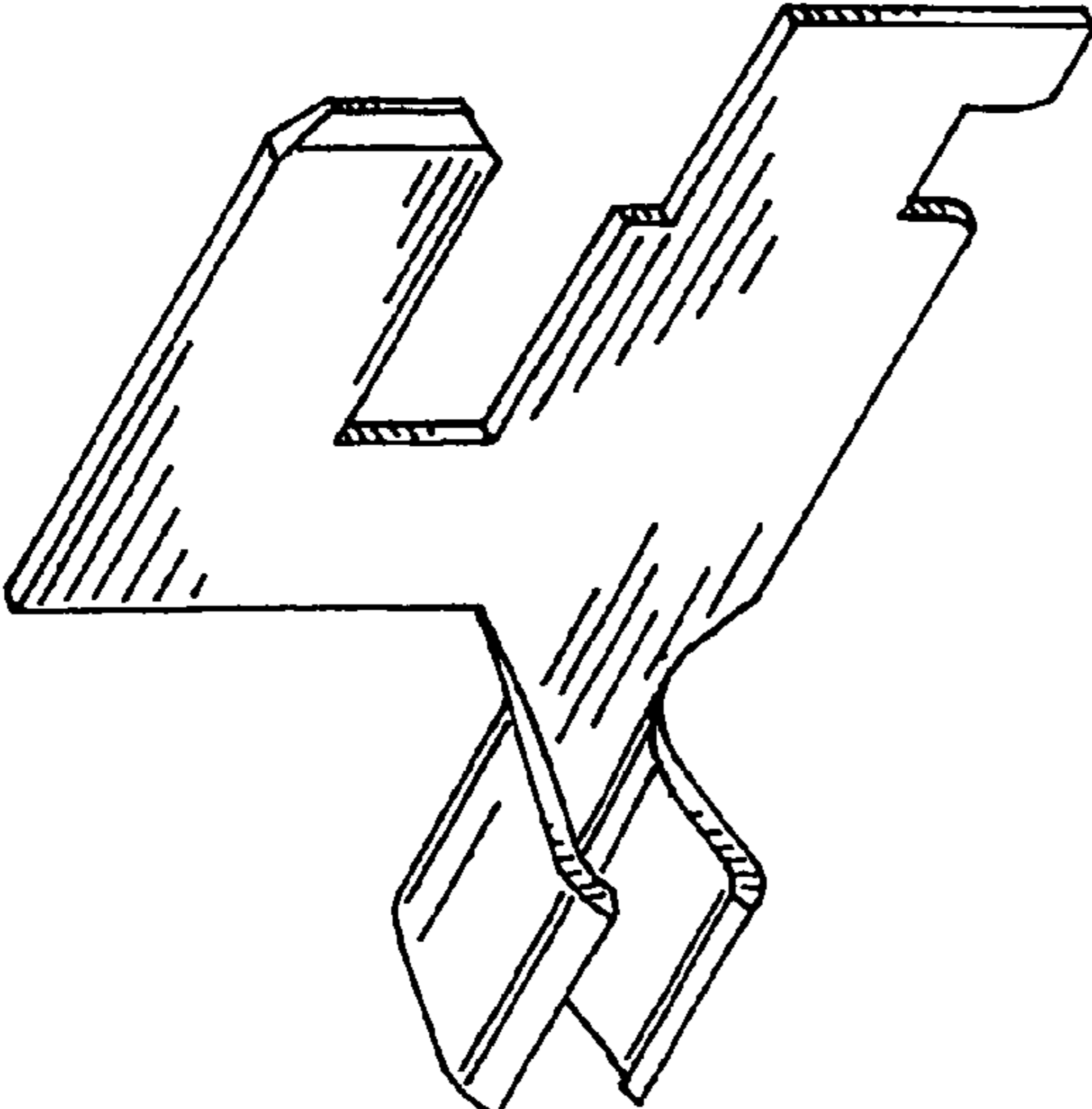

FIG. 1

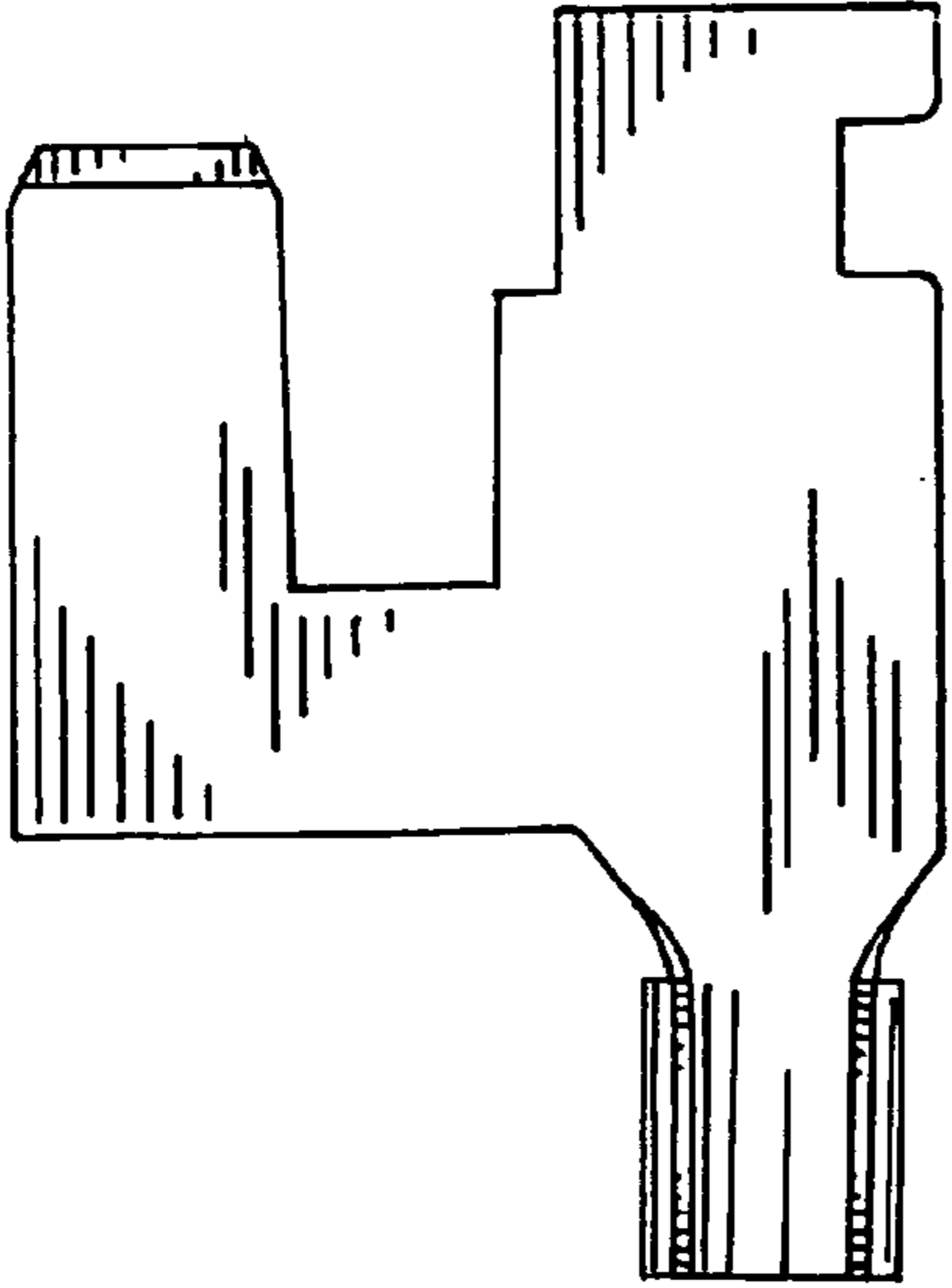

FIG. 2

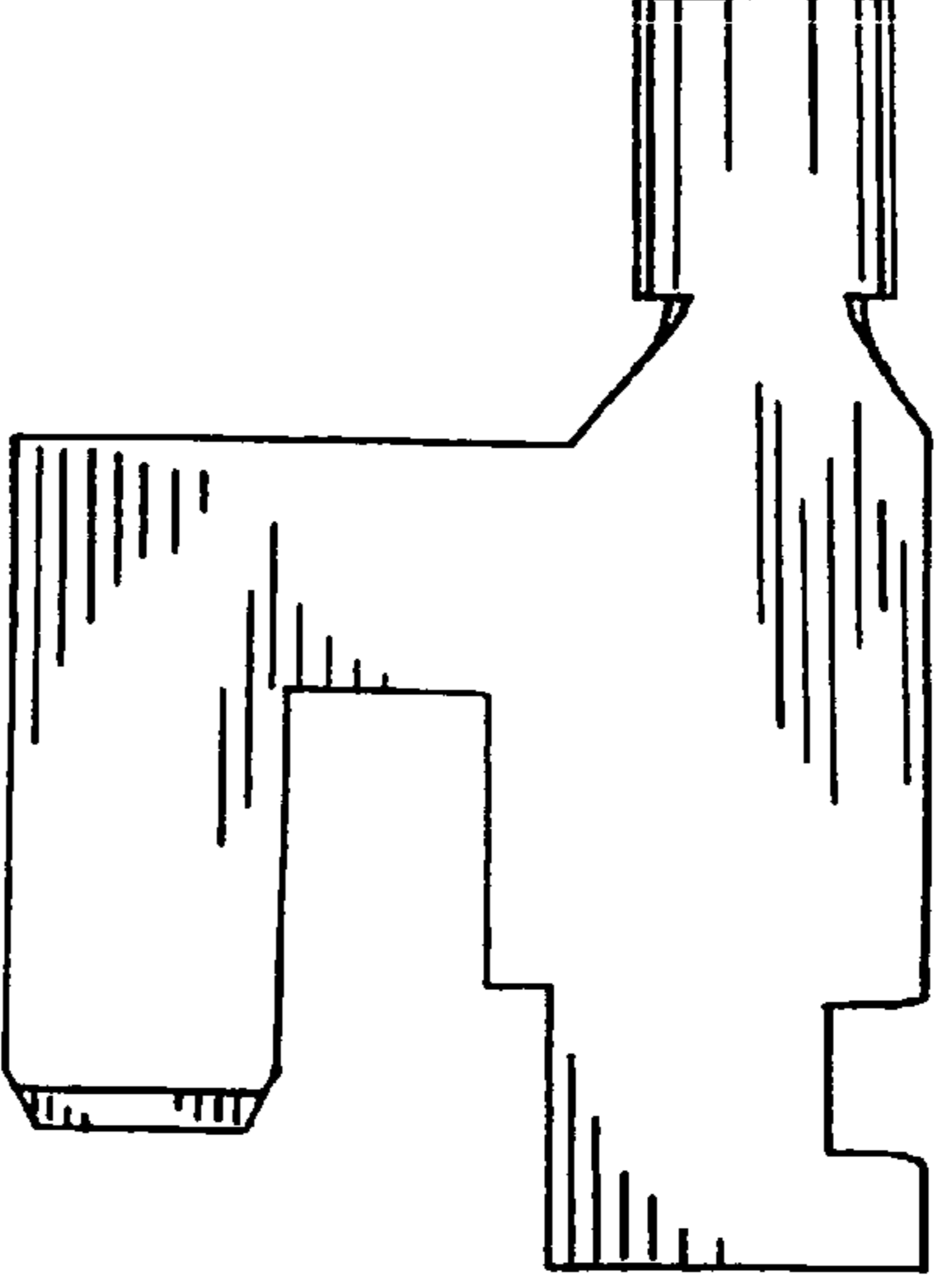

FIG. 3

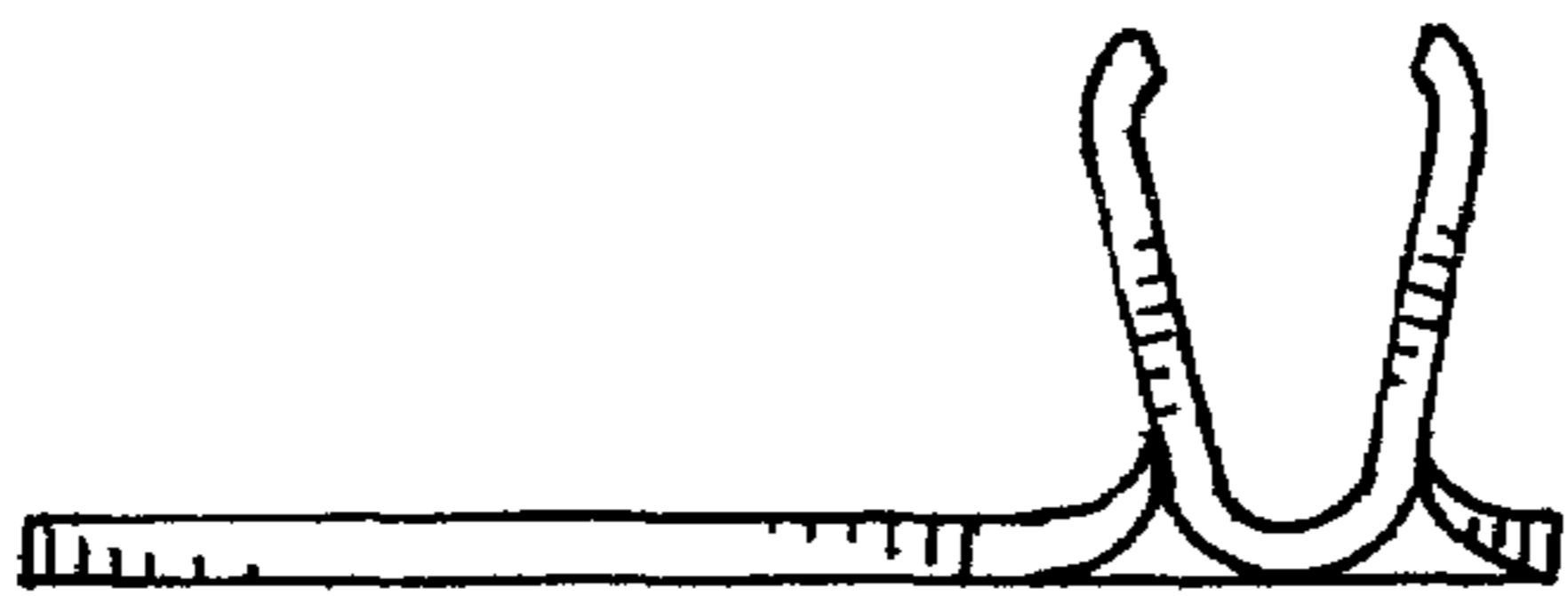

FIG. 4

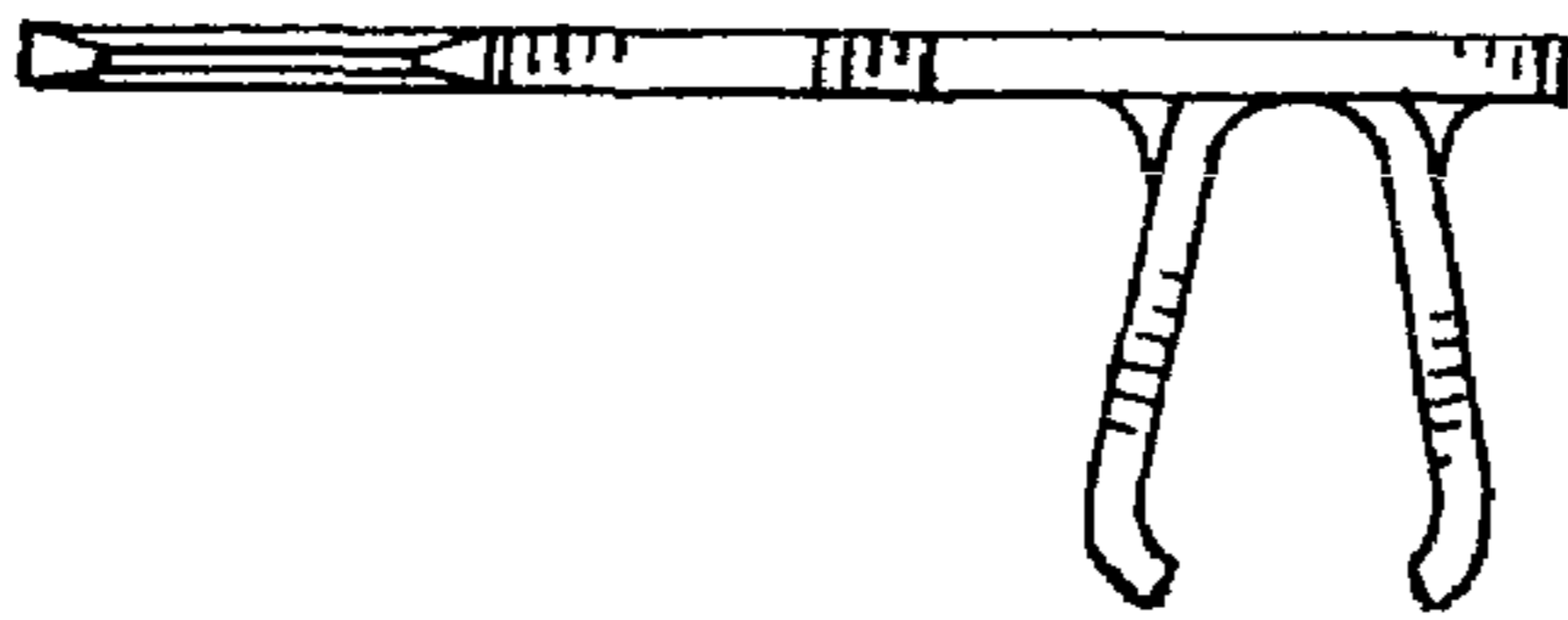

FIG. 5

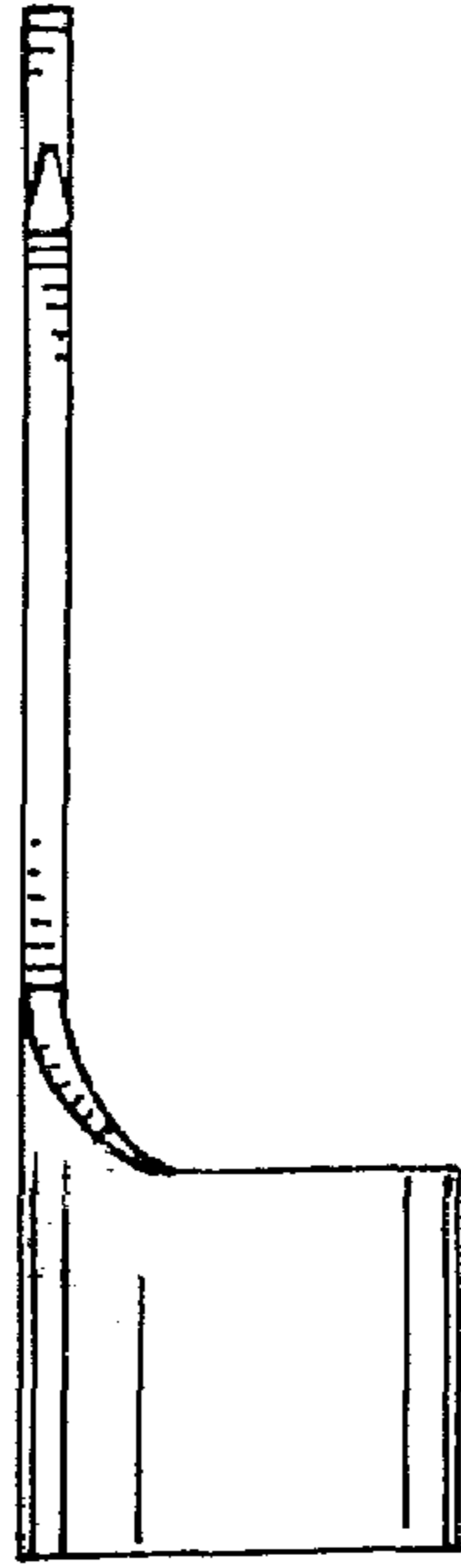

FIG. 6

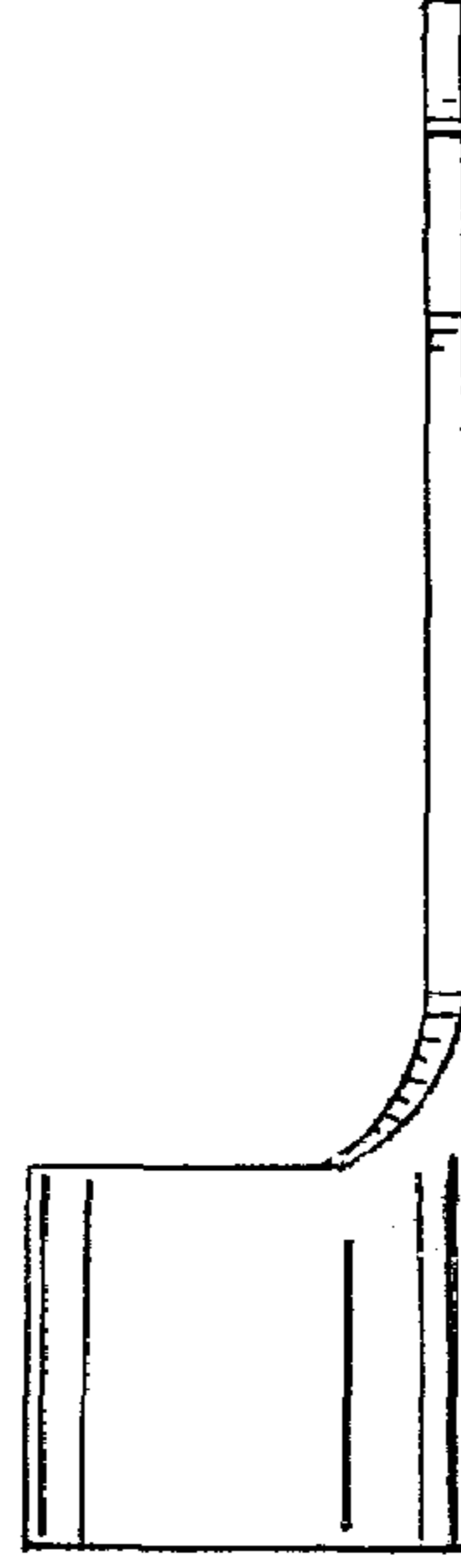

FIG. 7