

US00D553455S

(12) **United States Design Patent**  
**Shepardson**

(10) **Patent No.:** **US D553,455 S**  
(45) **Date of Patent:** **\*\* Oct. 23, 2007**

(54) **TREE AND PLANT WATERING SYSTEM  
RESERVOIR**

D373,078 S \* 8/1996 Cheng ..... D9/632  
5,791,082 A 8/1998 Finello  
6,497,071 B1 12/2002 Main et al.

(76) Inventor: **Heather Ann Shepardson**, 1011 Adams  
St., Denver, CO (US) 80206

**OTHER PUBLICATIONS**

advancedretailproducts.com web page. Note that domain name was  
surrendered and is not in use now.

(\*\*) Term: **14 Years**

\* cited by examiner

(21) Appl. No.: **29/240,844**

*Primary Examiner*—Holly H. Baynham

*Assistant Examiner*—Sheryl Friedman

(22) Filed: **Oct. 19, 2005**

(74) *Attorney, Agent, or Firm*—Marian J. Furst

**Related U.S. Application Data**

(63) Continuation-in-part of application No. 10/954,673,  
filed on Sep. 30, 2004.

(57) **CLAIM**

The ornamental design for a tree and plant watering system  
reservoir, as shown and described.

(51) **LOC (8) Cl.** ..... **08-01**

(52) **U.S. Cl.** ..... **D8/1**

(58) **Field of Classification Search** ..... D11/121,  
D11/117, 149; D8/1

See application file for complete search history.

**DESCRIPTION**

FIG. 1 is a perspective view of the tree and plant watering  
system reservoir of my new design;

FIG. 2 is a plan view of the bottom thereof;

FIG. 3 is a side view of a first side thereof;

FIG. 4 is a side view of one of the three other sides thereof;

FIG. 5 is a top view of the lid thereof; and,

FIG. 6 is a side view of the lid thereof.

The elements of the claim design are shown separately for  
clarity of illustration.

(56) **References Cited**

**U.S. PATENT DOCUMENTS**

1,421,443 A \* 7/1922 Fogel ..... 229/125.19  
2,141,839 A \* 12/1938 Hokerk ..... 229/5.7  
4,825,587 A 5/1989 Stancil  
5,157,868 A 10/1992 Munoz  
5,369,910 A 12/1994 Copenhaver  
5,497,876 A \* 3/1996 Fleming ..... 206/232  
5,522,179 A 6/1996 Hollis

**1 Claim, 3 Drawing Sheets**

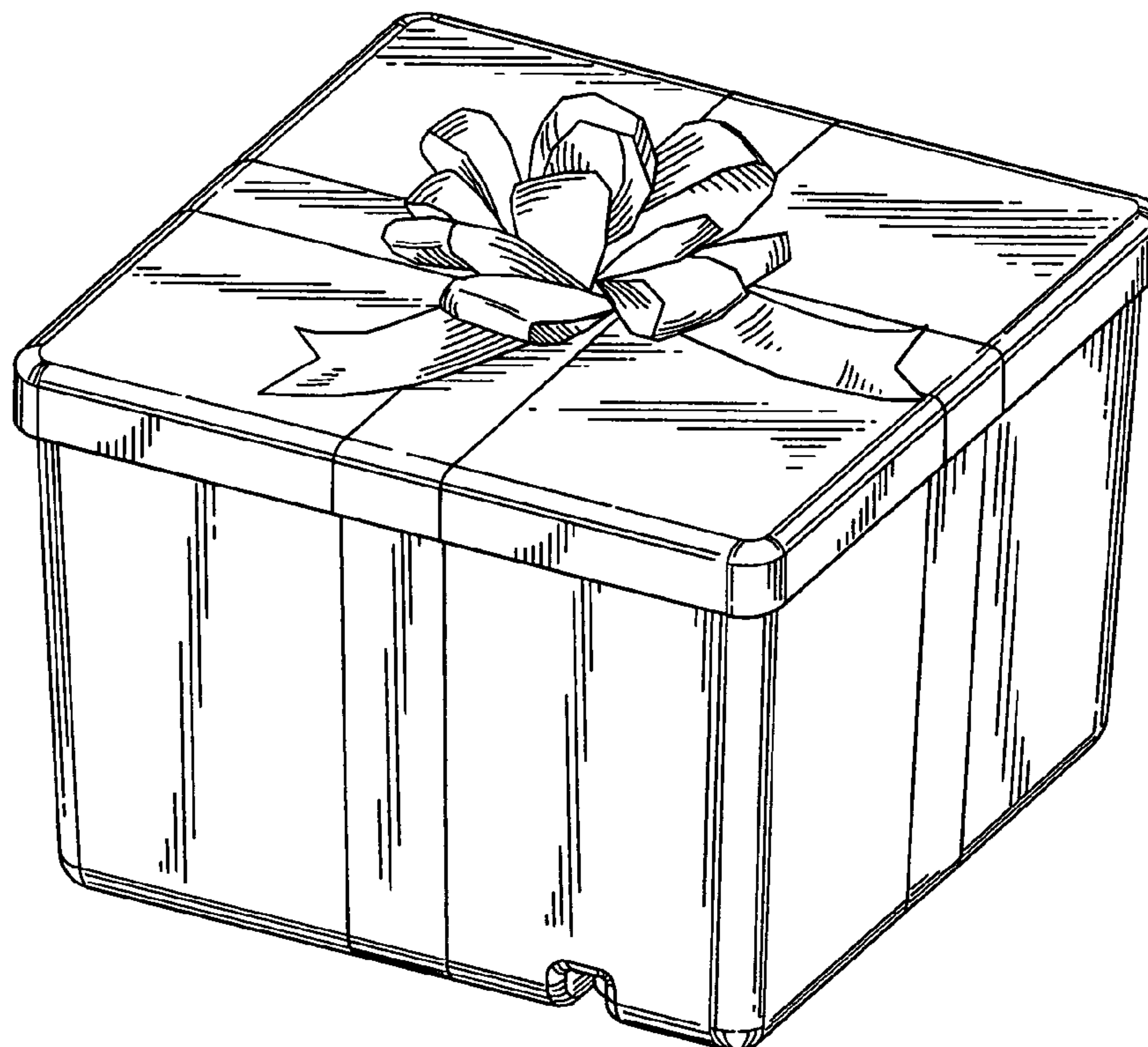

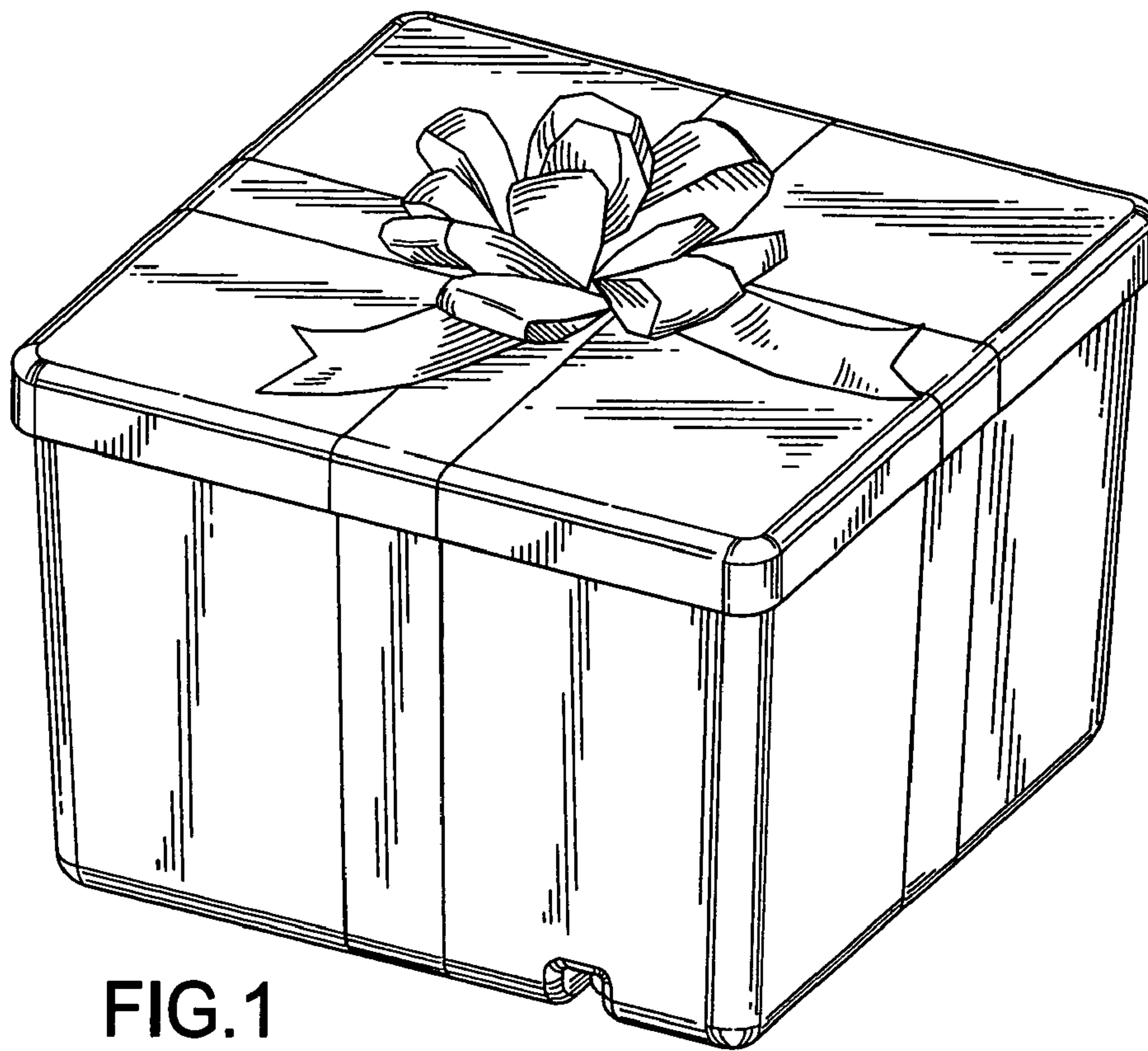

FIG. 1

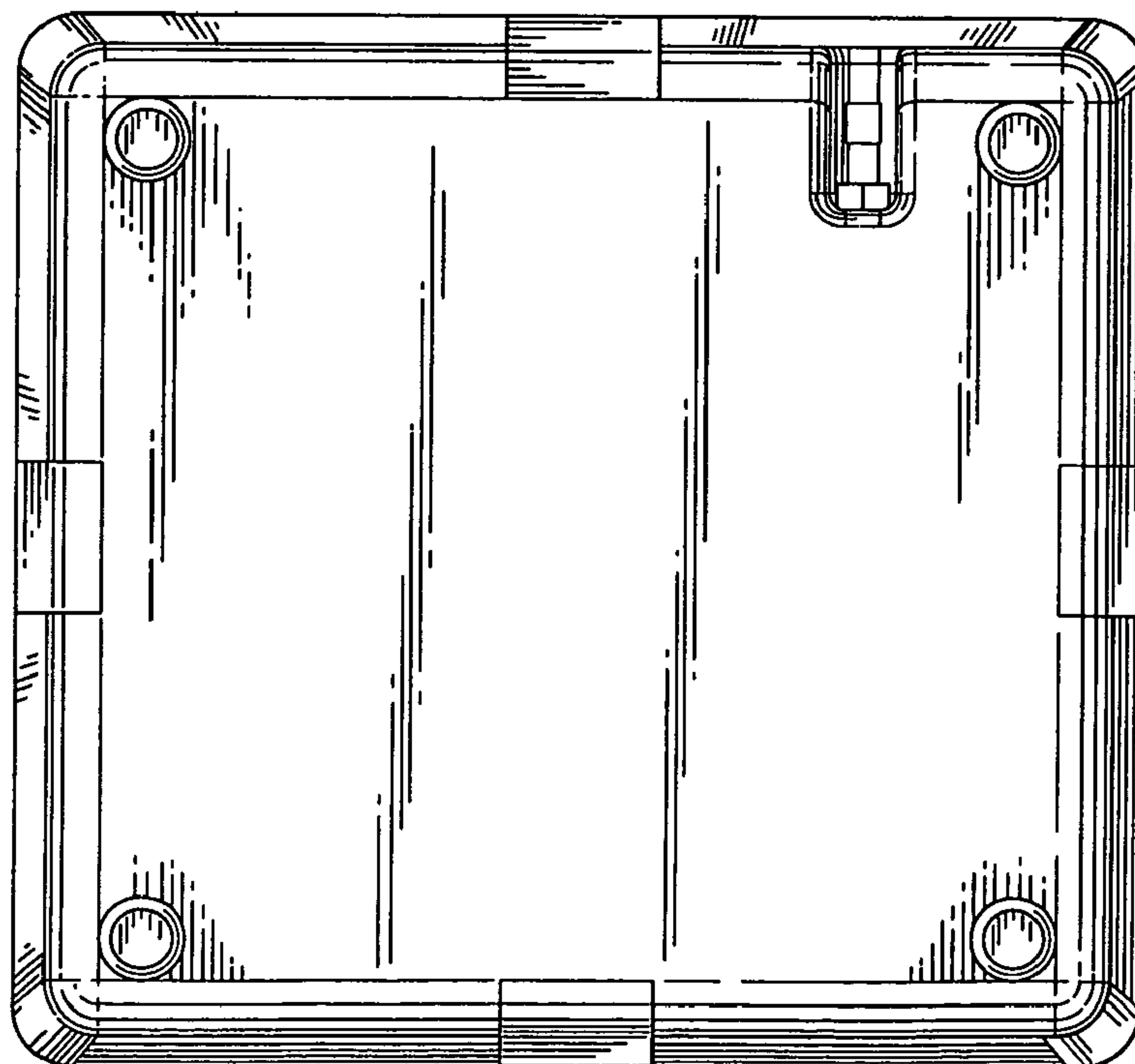

FIG. 2

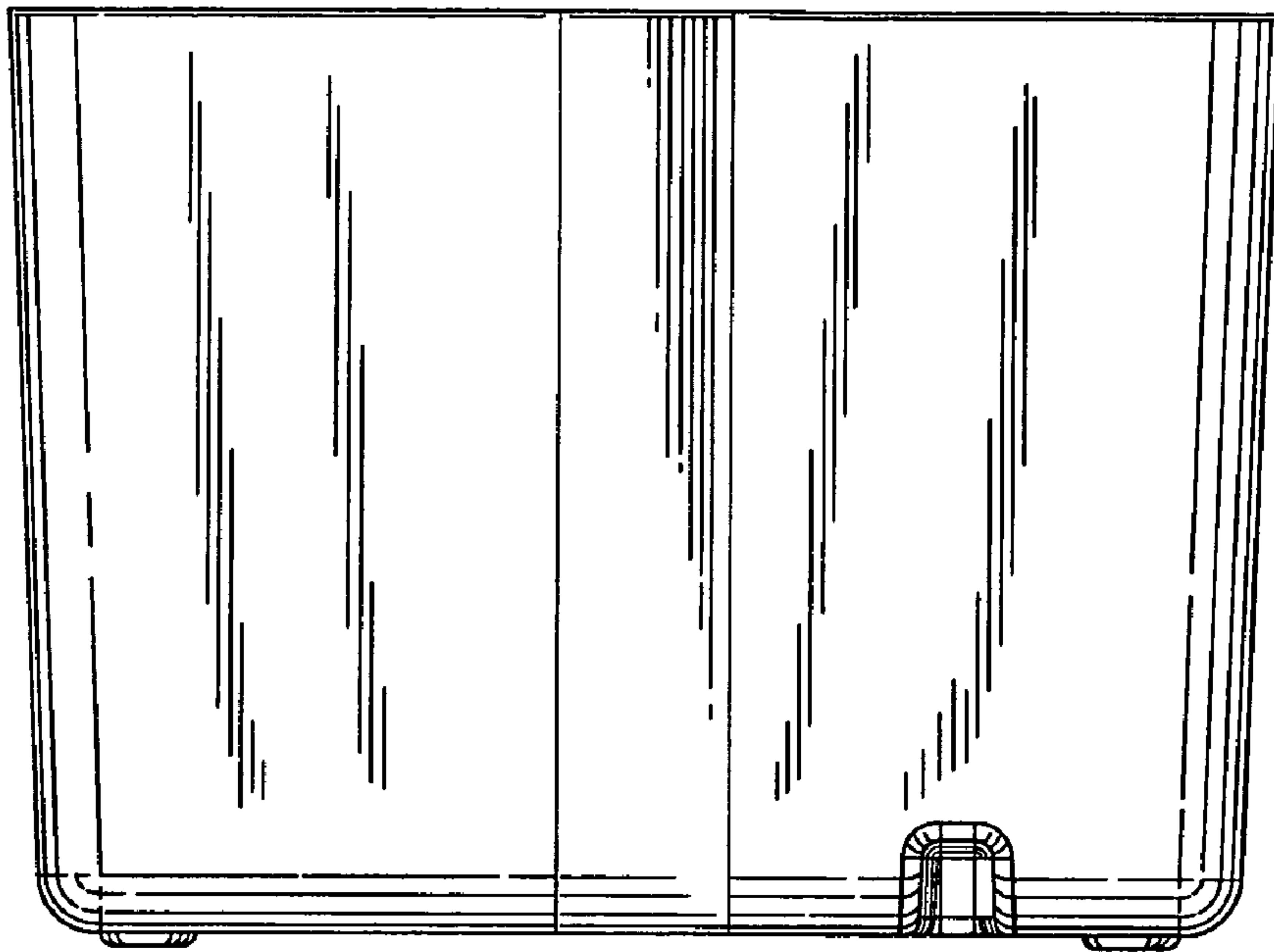

FIG.3

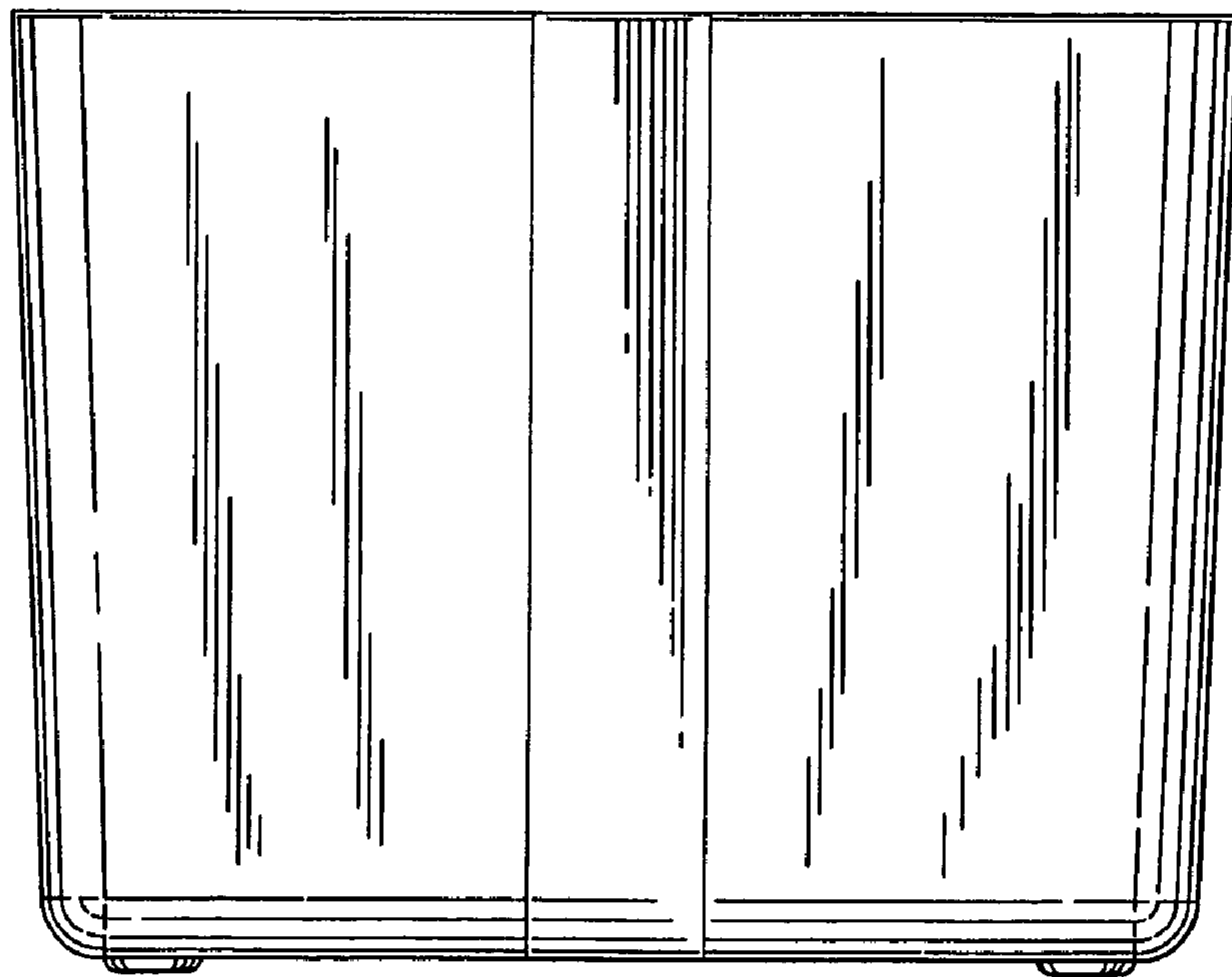

FIG.4

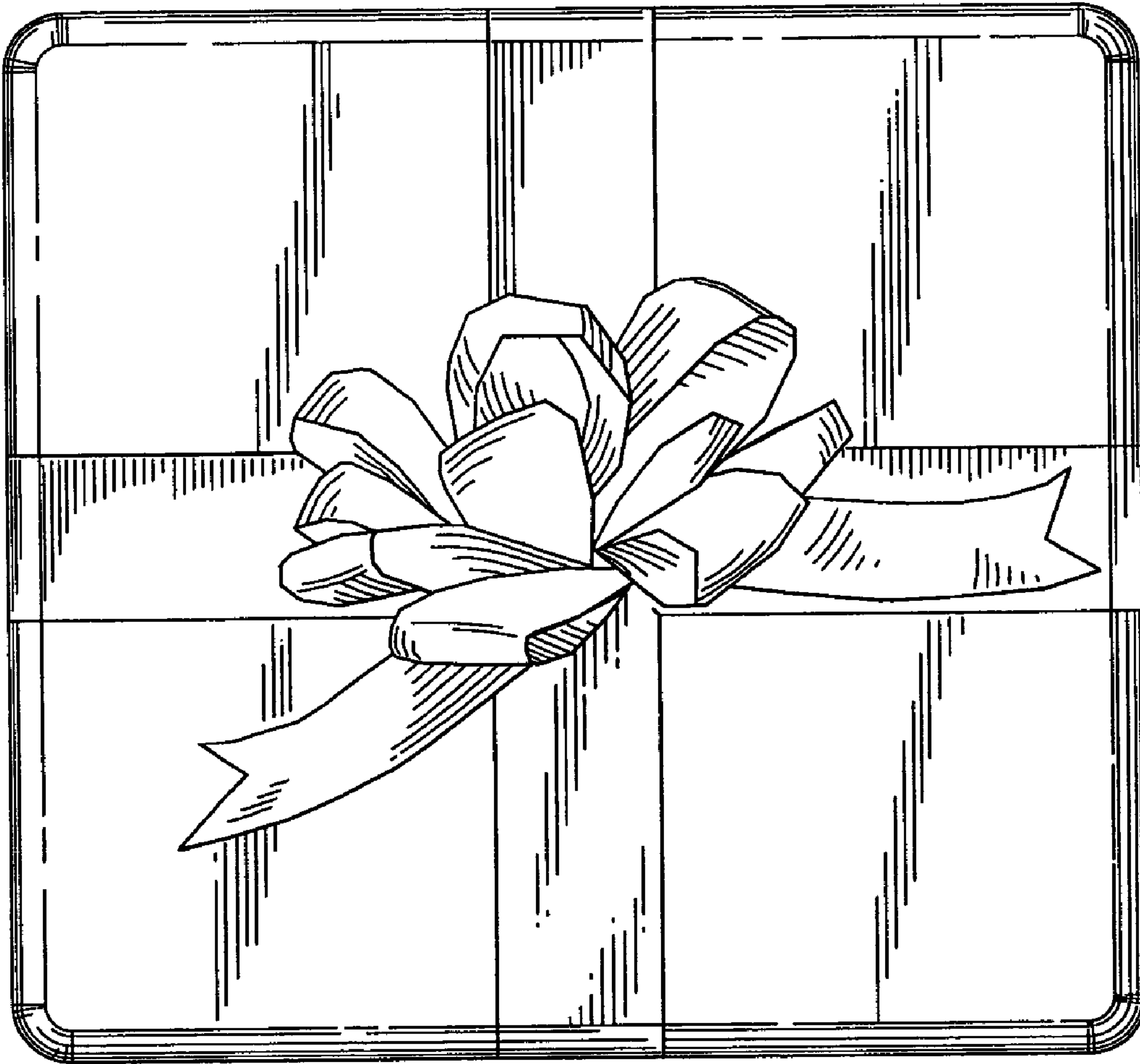

FIG. 5

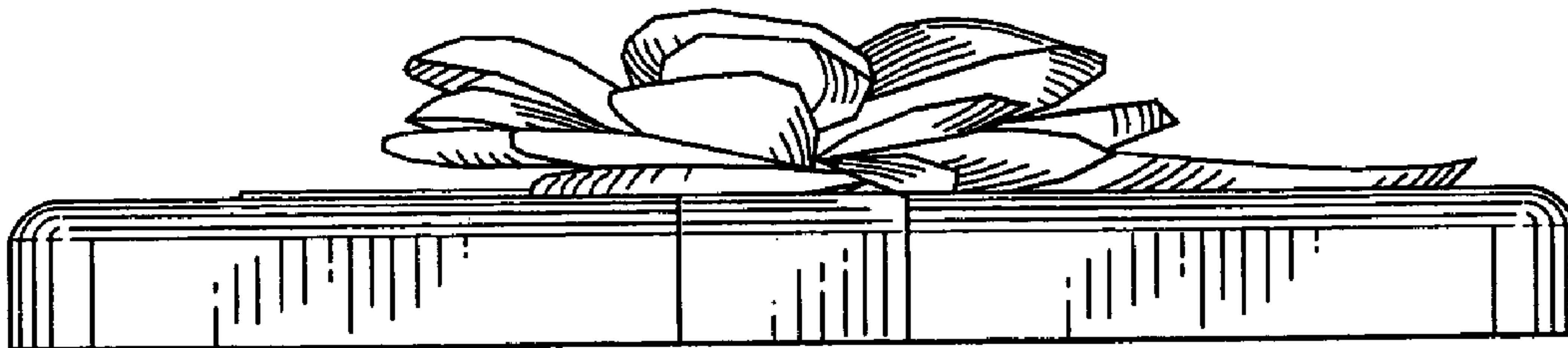

FIG. 6