



US00D553353S

(12) **United States Design Patent**
Karadimas

(10) **Patent No.:** **US D553,353 S**
(45) **Date of Patent:** **** Oct. 23, 2007**

(54) **FISHING GEAR HOLDER BELT**

(76) Inventor: **Chris Karadimas**, 1830 Brown St.,
Brooklyn, NY (US) 11229

(**) Term: **14 Years**

(21) Appl. No.: **29/243,727**

(22) Filed: **Dec. 1, 2005**

(51) **LOC (8) Cl.** **03-01**

(52) **U.S. Cl.** **D3/221**

(58) **Field of Classification Search** D3/221,
D3/215, 224, 226, 228; 224/920, 918, 604-605,
224/647-649; 43/54.1, 57.1

See application file for complete search history.

(56) **References Cited**

U.S. PATENT DOCUMENTS

2,782,553 A *	2/1957	Harris	43/57.1
D336,154 S *	6/1993	Phillips	D3/224
D371,456 S *	7/1996	Champlin et al.	D3/224
D505,008 S *	5/2005	Malik	D3/224
2003/0173390 A1 *	9/2003	Smith	224/920

* cited by examiner

Primary Examiner—Catherine R. Oliver

(74) *Attorney, Agent, or Firm*—Betty Tufariello

(57) **CLAIM**

The ornamental design for a fishing gear holder belt, as shown.

DESCRIPTION

FIG. 1 is a front elevation of the fishing gear holder belt showing my new design;

FIG. 2 is a rear elevation thereof;

FIG. 3 is a right side elevation thereof;

FIG. 4 is a left side elevation thereof;

FIG. 5 is a top plan view thereof;

FIG. 6 is a bottom plan thereof;

FIG. 7 is a front elevational view showing the fishing gear holder belt as it would appear if it was secured about the waist of a fisherman in its use position. The needle-nose pliers, the bottom portion of a fishing rod and the scissors being for illustrative purposes only form no part of the claimed design;

FIG. 8 is a rear elevational view showing the fishing gear holder belt as it would appear if it was secured about the waist of a fisherman in its use position. The needle-nose pliers and the scissors being for illustrative purposes only form no part of the claimed design;

FIG. 9 is a right side elevational view showing the fishing gear holder belt as it would appear if it was secured about the waist of a fisherman in its use position. The needle-nose pliers and the bottom portion of a fishing rod being for illustrative purposes only form no part of the claimed design; and,

FIG. 10 is a left side elevational view showing the fishing gear holder belt as it would appear if it was secured about the waist of a fisherman in its use position.

The scissors and the bottom portion of a fishing rod being for illustrative purposes only form no part of the claimed design.

1 Claim, 10 Drawing Sheets

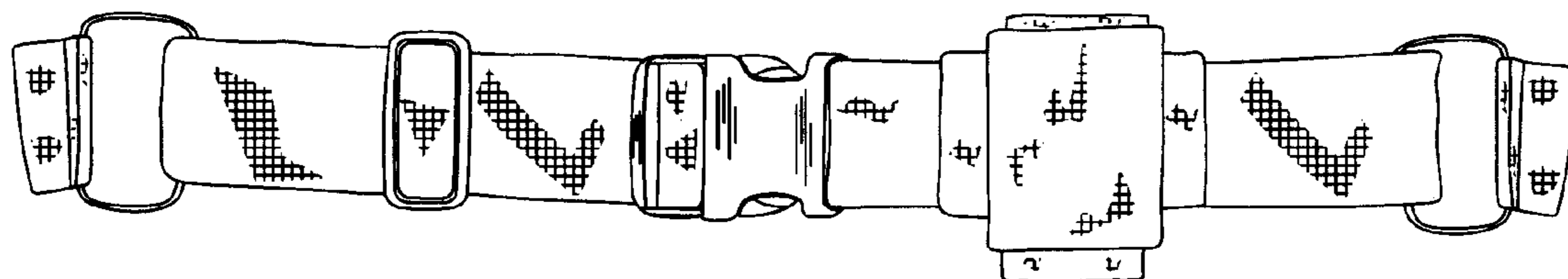

FIG. 1

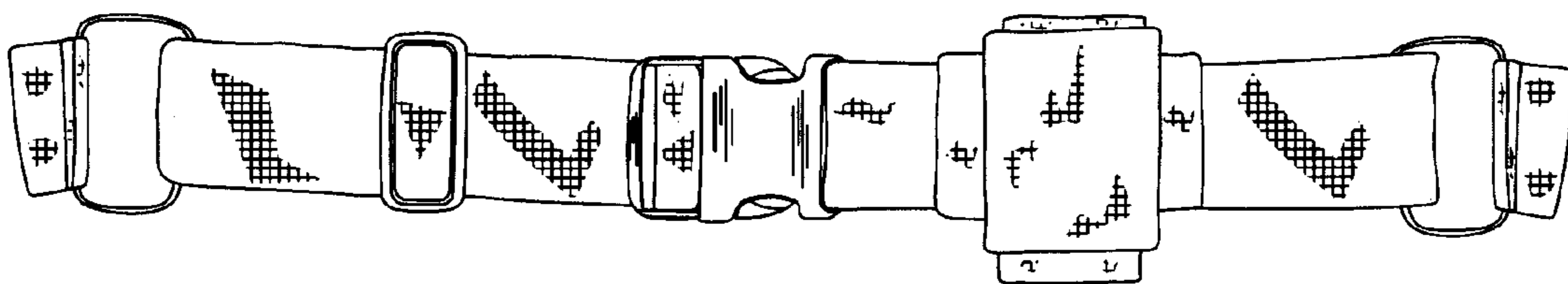

FIG. 2

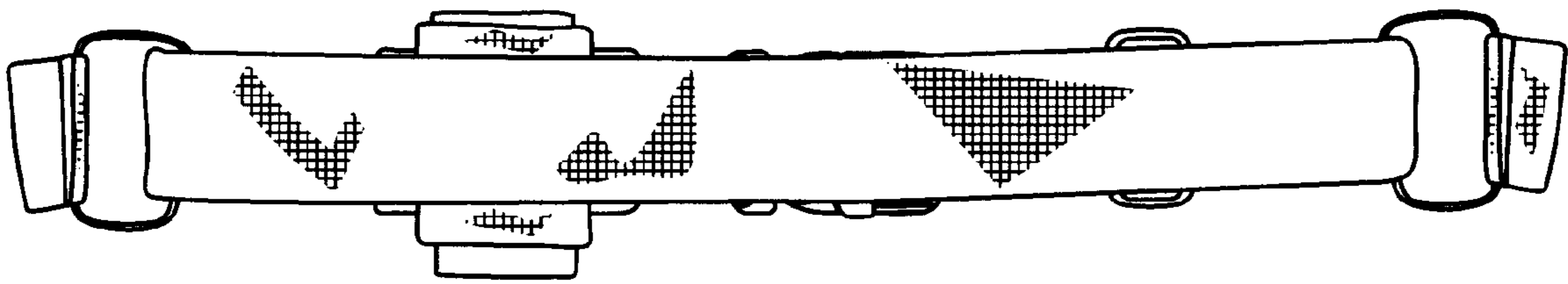

FIG. 3

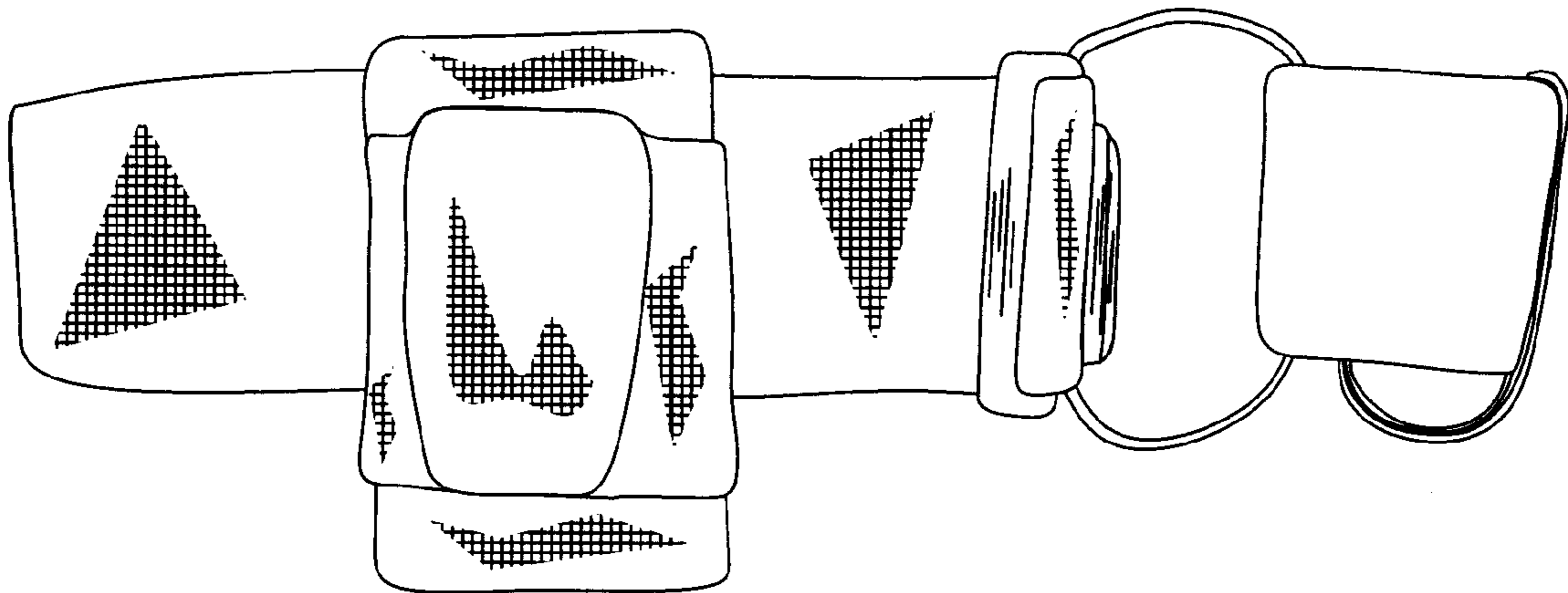

FIG. 4

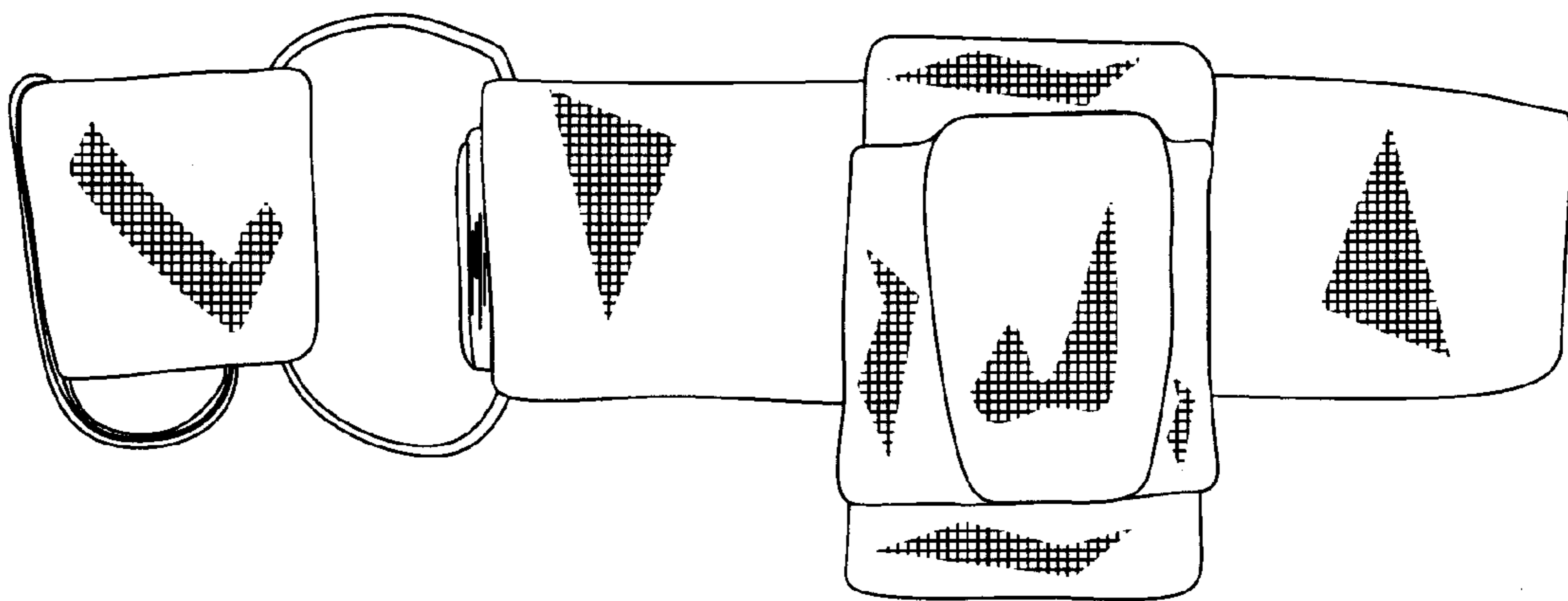

FIG. 5

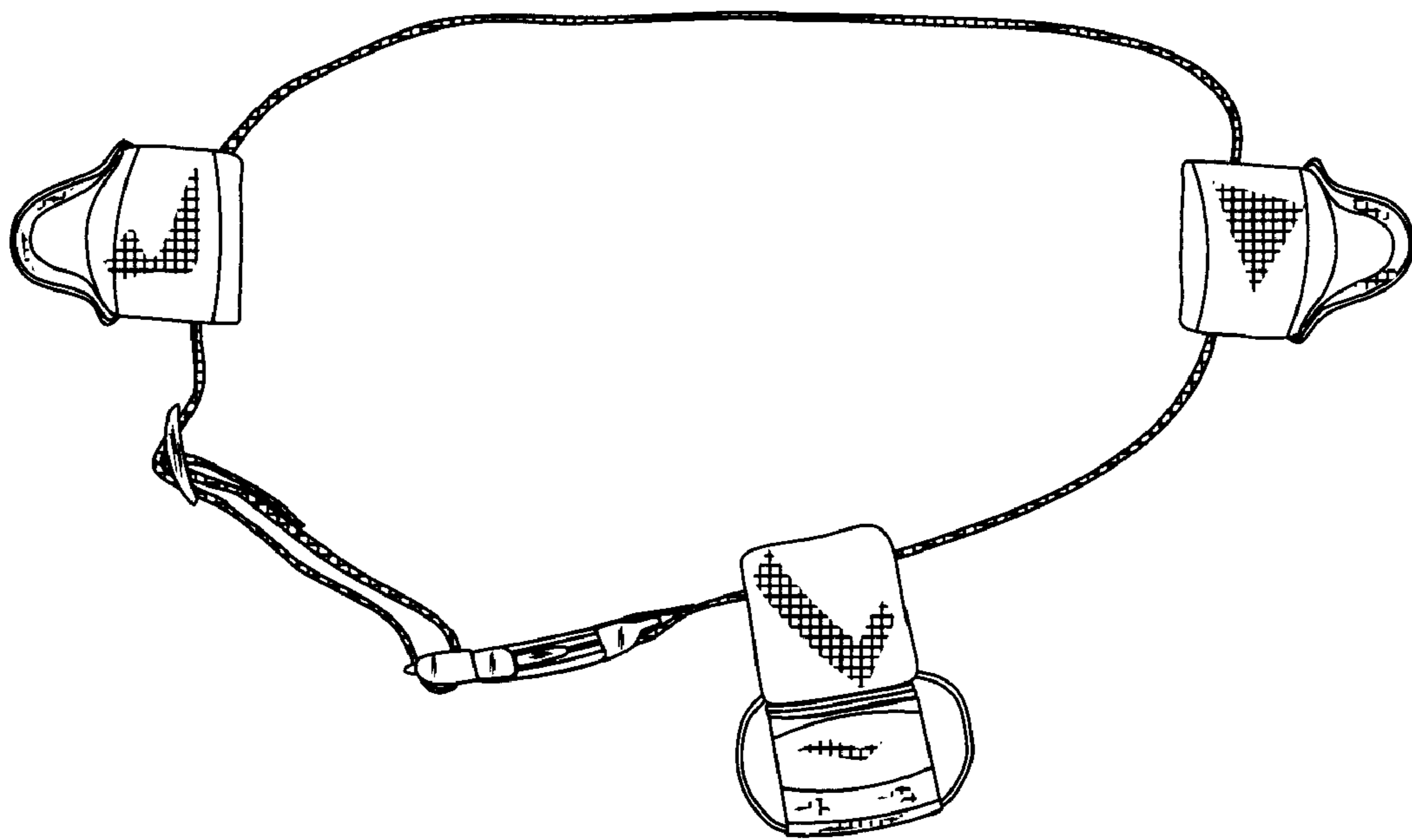

FIG. 6

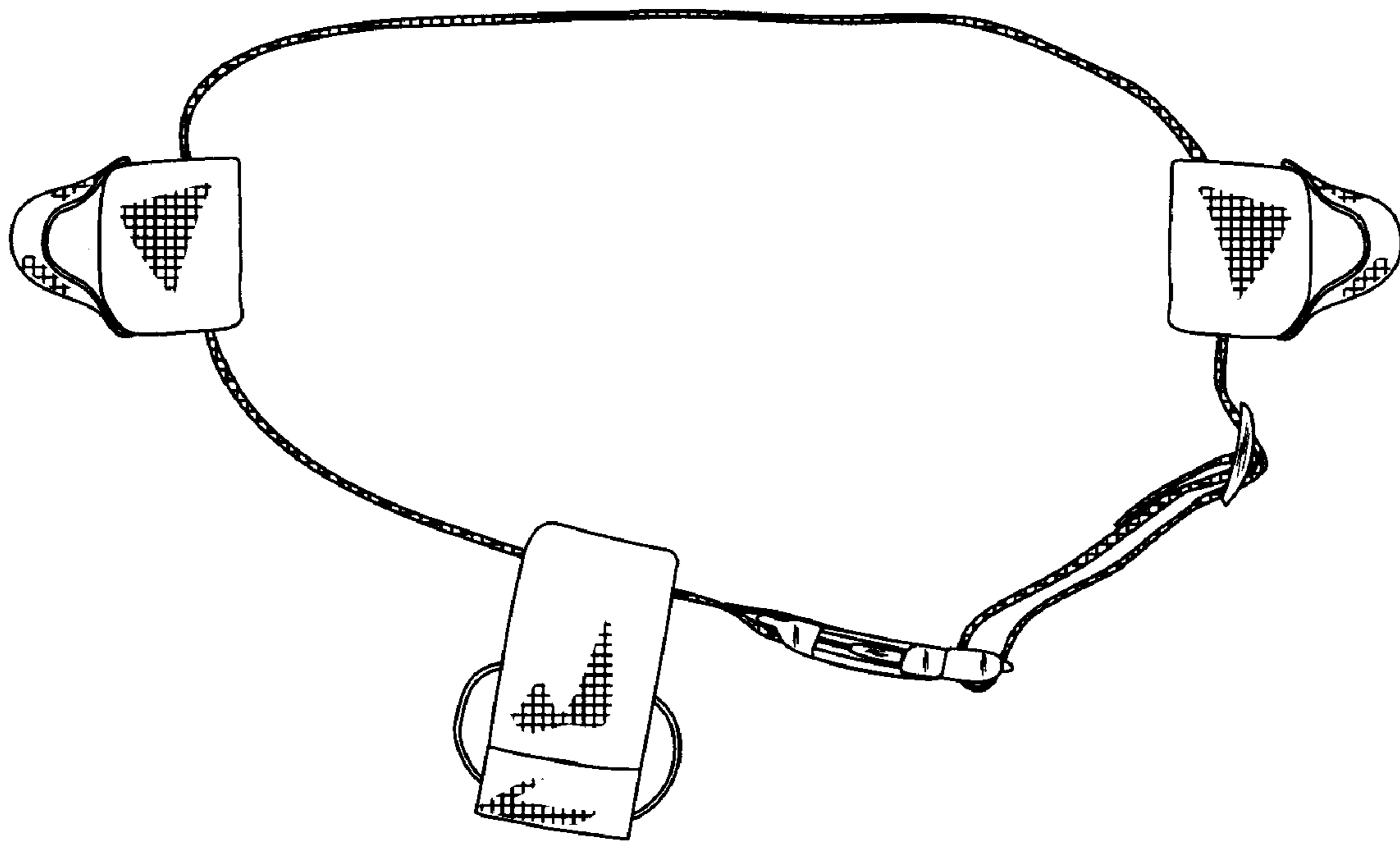

FIG. 7

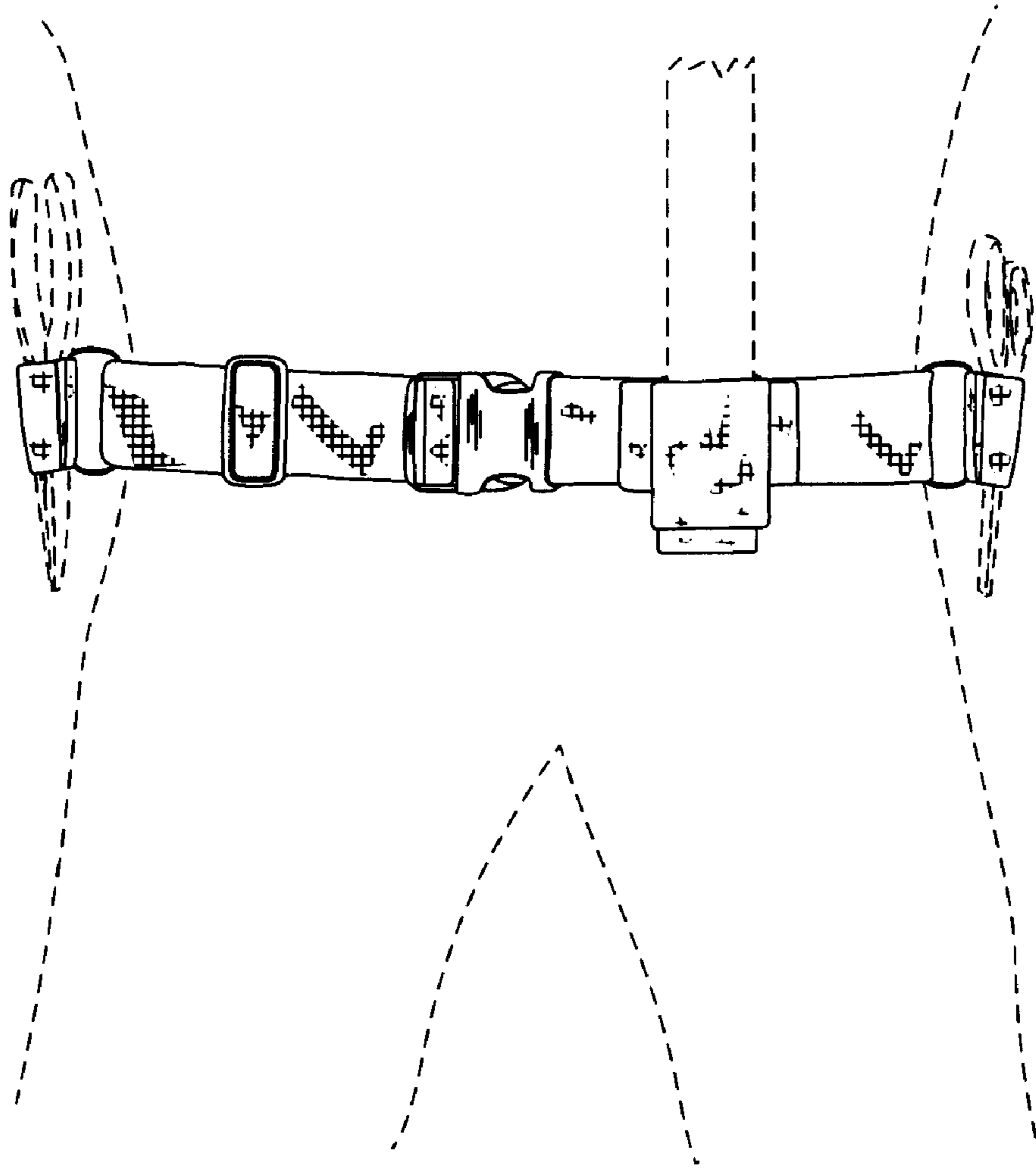

FIG. 8

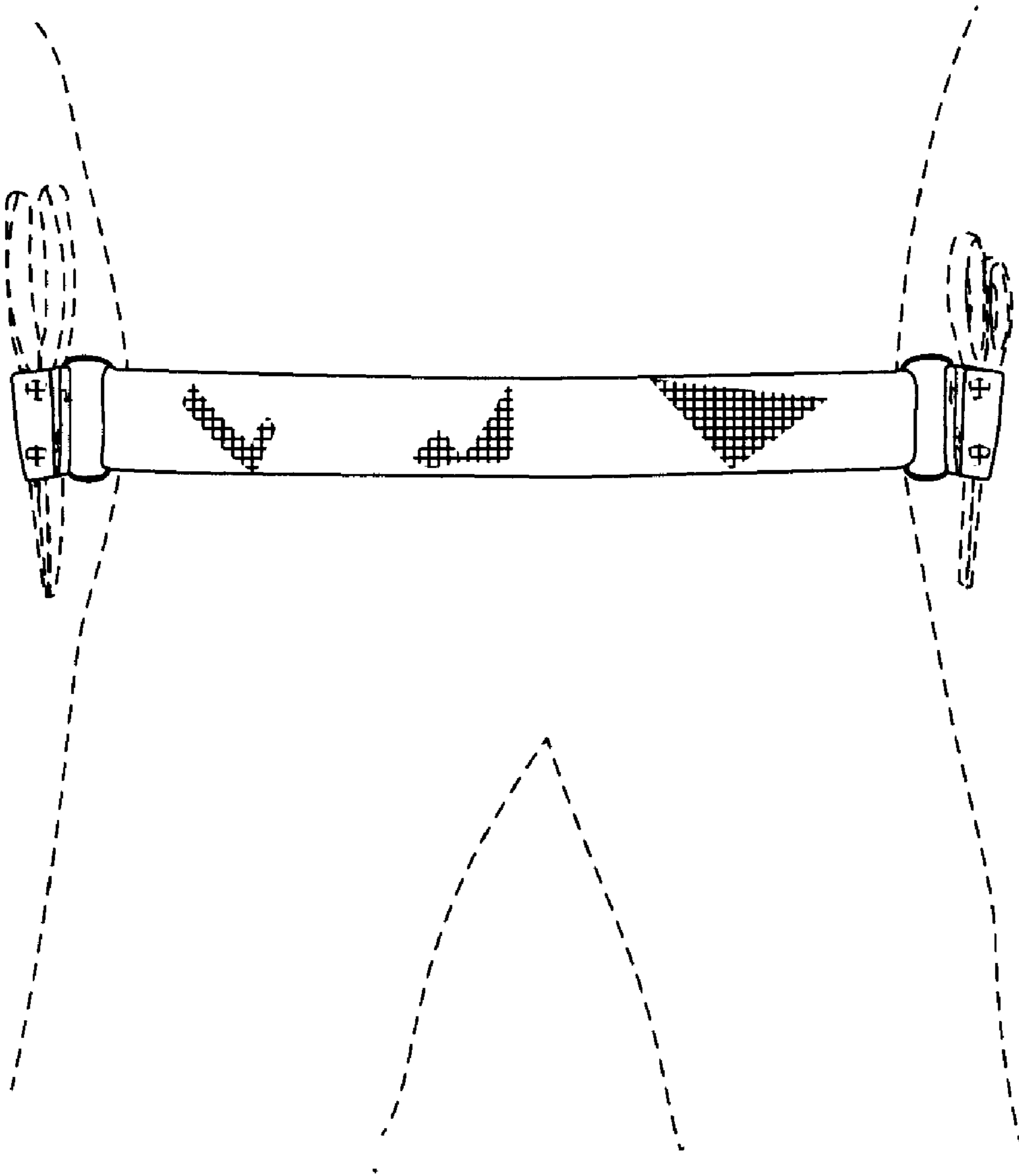

FIG. 9

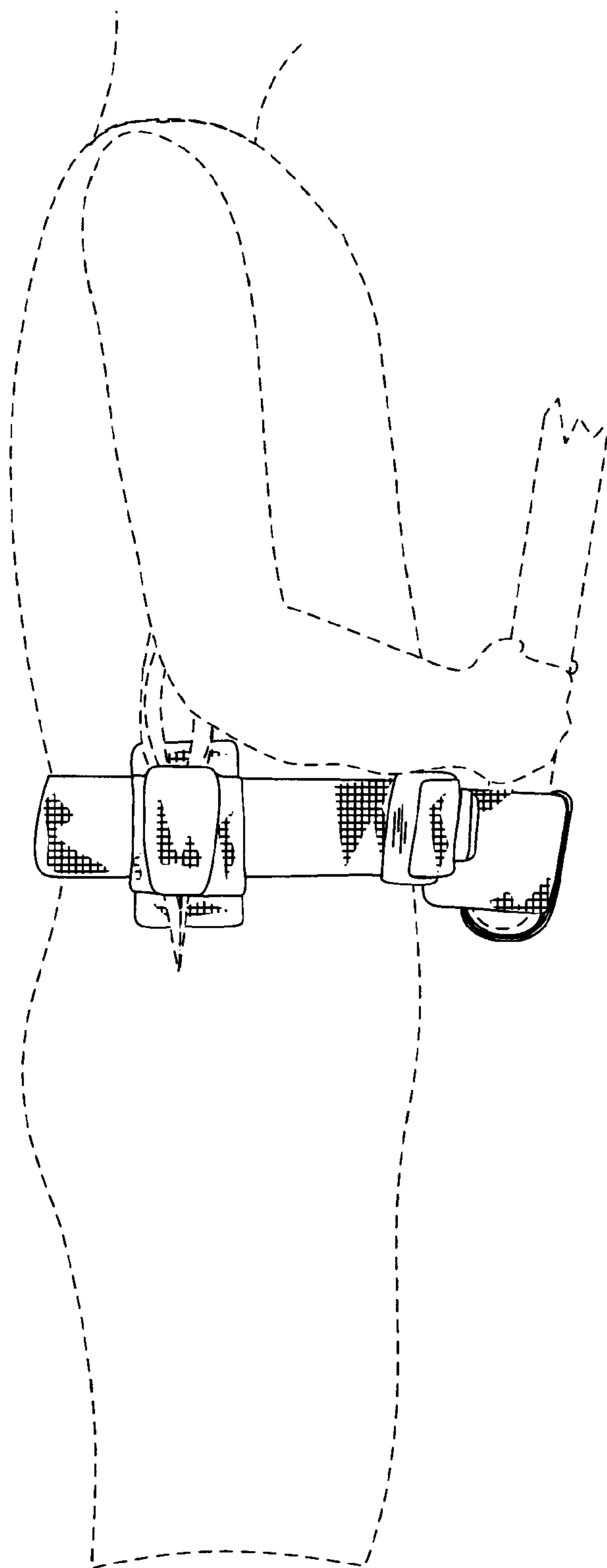

FIG. 10

