



US00D553328S

(12) **United States Design Patent**
King

(10) **Patent No.:** **US D553,328 S**

(45) **Date of Patent:** **** Oct. 23, 2007**

(54) **SHOULDER STRAP FOR USE WITH A BAG OR MEDICAL DEVICE**

(75) Inventor: **Andrew King**, Victoria (AU)

(73) Assignee: **Ventrassist Pty Ltd.**, Chatswood (AU)

(**) Term: **14 Years**

(21) Appl. No.: **29/258,206**

(22) Filed: **Apr. 18, 2006**

(30) **Foreign Application Priority Data**

Apr. 13, 2006 (AU) 11532/06

(51) **LOC (8) Cl.** **02-07**

(52) **U.S. Cl.** **D2/624; D2/640**

(58) **Field of Classification Search** D2/624,
D2/625, 626, 627, 633, 635, 640, 707, 708;
2/44, 45, 300, 310, 338, 340; 24/72.1, 265 R,
24/265 EC, 265 H; D3/327; D24/190, 191
See application file for complete search history.

(56) **References Cited**

U.S. PATENT DOCUMENTS

898,789	A *	9/1908	Sohleicher	59/95
2,643,380	A *	6/1953	Blair	2/460
4,472,838	A *	9/1984	Pompa	2/460
4,978,044	A *	12/1990	Silver	224/601
D325,470	S *	4/1992	Harms	D3/327
5,388,743	A *	2/1995	Silagy	224/264
D361,081	S *	8/1995	Pardinas	D16/339
D375,823	S *	11/1996	Bleiweis	D29/101.5
D386,310	S *	11/1997	Smith	D3/327
5,765,735	A *	6/1998	Kimchi et al.	224/264
D406,455	S *	3/1999	Wagner, II	D3/226
D407,867	S *	4/1999	Rubinstein	D30/153

D411,666	S *	6/1999	Reimers et al.	D3/327
6,115,849	A *	9/2000	Meyerrose	2/452
D479,554	S *	9/2003	Boron et al.	D17/20
6,651,594	B1 *	11/2003	Bagwell	119/770
D489,163	S *	5/2004	Tucker	D2/639
D489,182	S *	5/2004	Tilby et al.	D3/327
6,910,227	B2 *	6/2005	Lee	2/268
D524,049	S *	7/2006	Hughes	D3/289
D544,211	S *	6/2007	Herzberg	D3/327

* cited by examiner

Primary Examiner—Stella M. Reid

Assistant Examiner—Elizabeth J Oswecki

(74) *Attorney, Agent, or Firm*—Kaplan Gilman Gibson & Dernier LLP

(57) **CLAIM**

The ornamental design for a shoulder strap for use with a bag or medical device, as shown and described.

DESCRIPTION

FIG. 1 is a left side view of the shoulder strap for use with a bag or medical device;

FIG. 2 is a right side view thereof;

FIG. 3 is a top view thereof;

FIG. 4 is an underside view thereof;

FIG. 5 is a front view thereof;

FIG. 6 is a rear view thereof;

FIG. 7 is a front perspective view thereof; and,

FIG. 8 is a rear perspective view thereof.

The broken line showing of the shoulder strap is included for the purpose of illustrating only and forms no part of the claimed design.

1 Claim, 7 Drawing Sheets

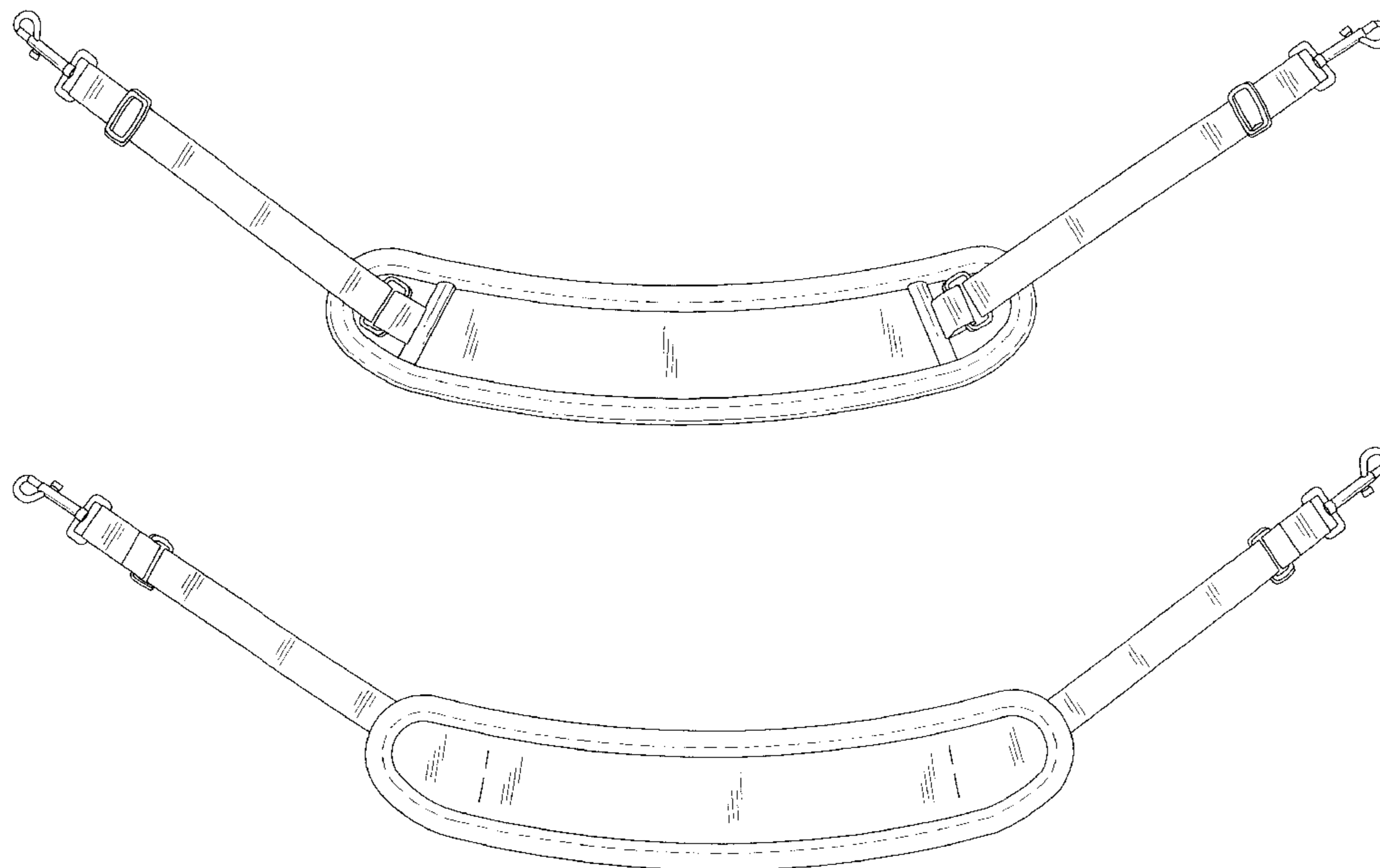

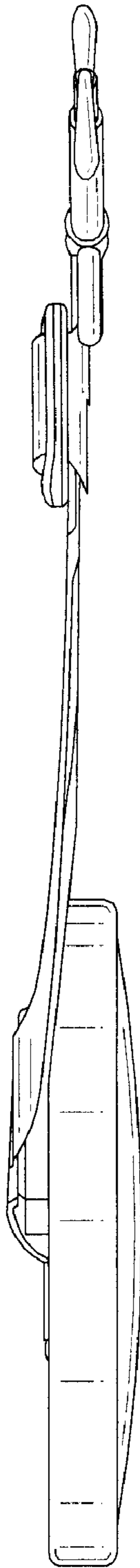

FIG. 1



FIG. 2

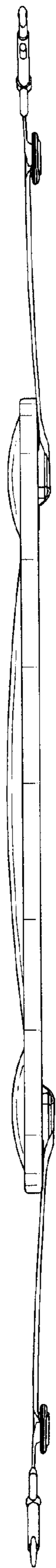

FIG. 3

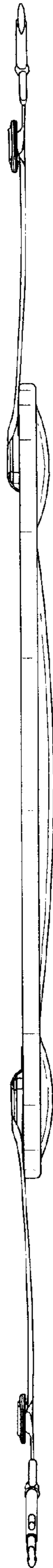

FIG. 4

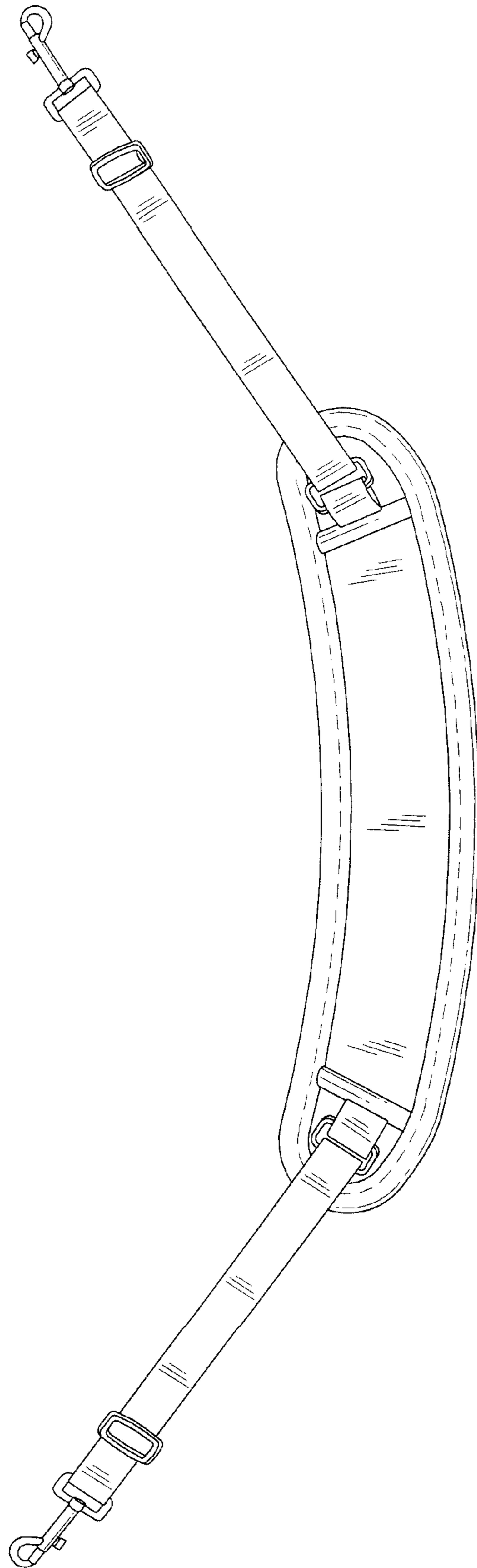

FIG. 5

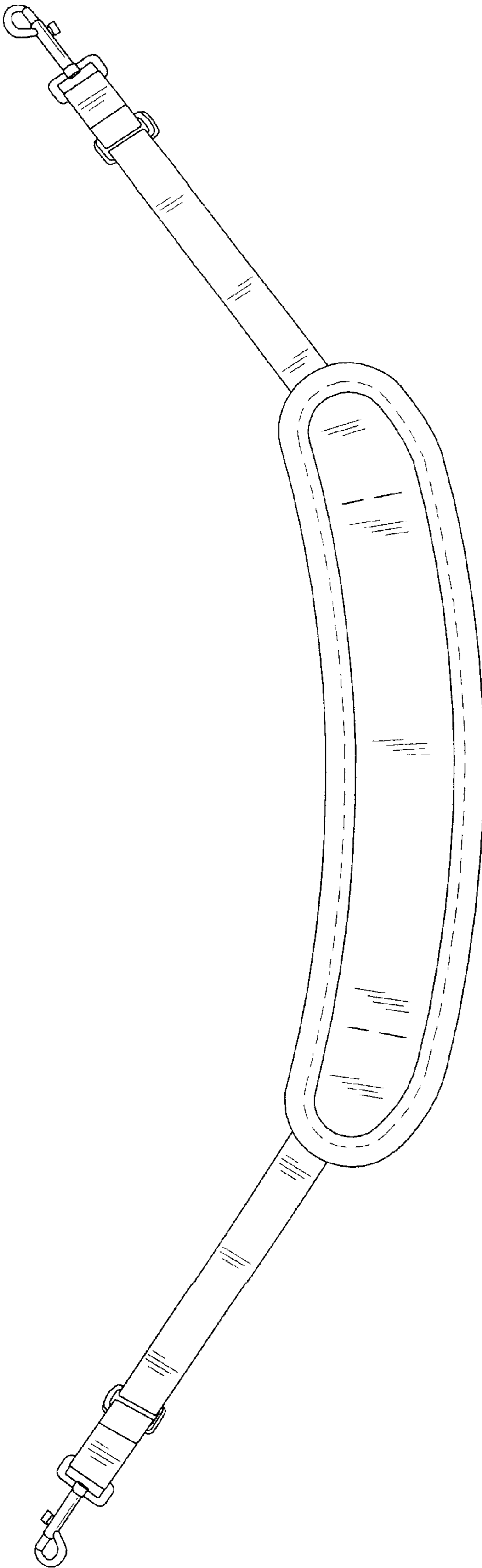

FIG. 6

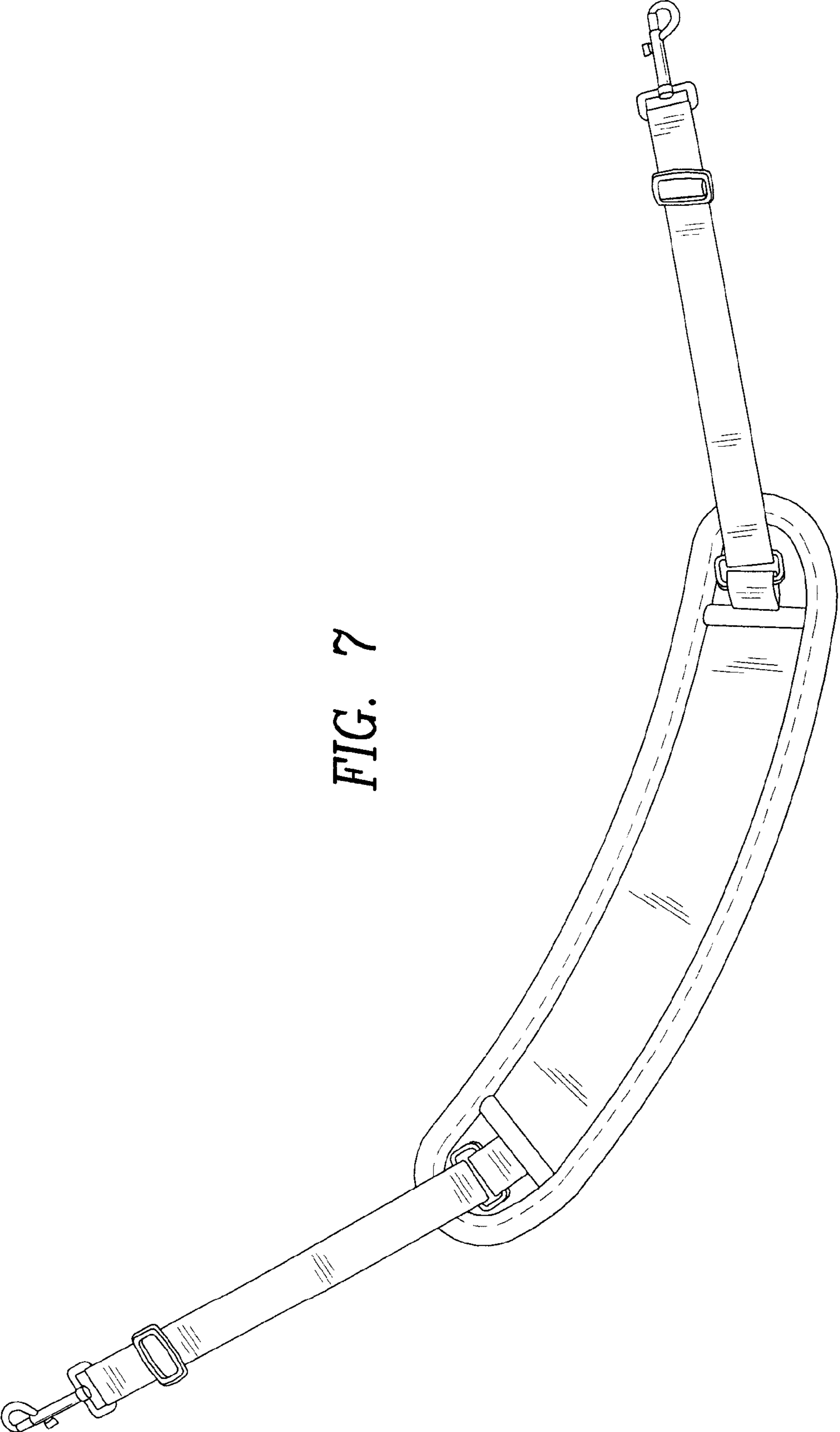

FIG. 7

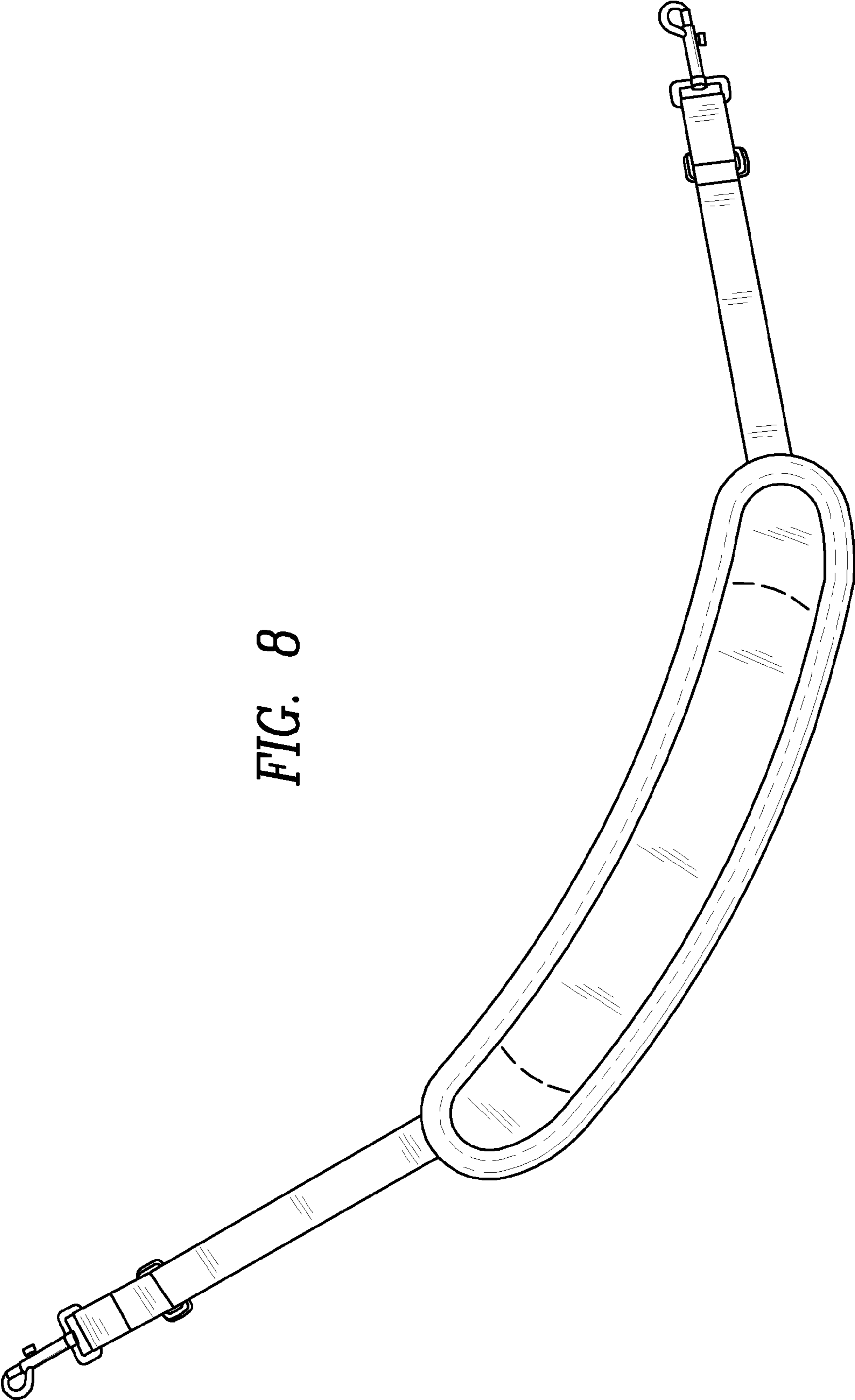

FIG. 8