



US00D553303S

(12) **United States Design Patent** (10) **Patent No.:** **US D553,303 S**
So (45) **Date of Patent:** **** Oct. 16, 2007**

(54) **PROTECTIVE PAD**

(75) Inventor: **Kainin Andrew So**, Chaiwan (HK)

(73) Assignee: **Marco Skates Limited**, Chaiwan, Hong Kong (CN)

(**) Term: **14 Years**

(21) Appl. No.: **29/263,292**

(22) Filed: **Jul. 19, 2006**

(30) **Foreign Application Priority Data**

Jan. 24, 2006 (CN) 2006 3 0005100

(51) **LOC (8) Cl.** **02-04**

(52) **U.S. Cl.** **D29/121.1**

(58) **Field of Classification Search** D29/100,
D29/101.2, 101.5, 120.1, 121.2, 122; D24/190,
D24/192; 2/22-24, 62, 227, 238, 267, 455,
2/911; 602/30, 60-62; 128/882; 36/72 R,
36/94-96

See application file for complete search history.

(56) **References Cited**

U.S. PATENT DOCUMENTS

3,044,075	A *	7/1962	Rawlings	2/22
4,333,181	A *	6/1982	Corriero	2/24
4,512,037	A *	4/1985	Vacanti	2/22
D346,245	S *	4/1994	Krent et al.	D29/121.1
D355,052	S *	1/1995	Paikos et al.	D29/100
5,423,087	A *	6/1995	Krent et al.	2/463
5,500,955	A *	3/1996	Gongea	2/24
5,594,954	A *	1/1997	Huang	2/24

D380,876	S *	7/1997	Campbell	D29/121.1
D404,173	S *	1/1999	Popowski	D29/121.1
D408,596	S *	4/1999	Dancyger	D29/121.1
5,890,224	A *	4/1999	Clark	2/22
5,915,529	A *	6/1999	Popowski	2/16
D436,696	S *	1/2001	Bonaventure et al.	..	D29/121.1
D453,976	S *	2/2002	Slutterback	D29/121.1
6,374,409	B1 *	4/2002	Galy	2/24
D474,310	S *	5/2003	Tonkin	D29/100

* cited by examiner

Primary Examiner—T. Chase Nelson

Assistant Examiner—Karen Acker

(74) *Attorney, Agent, or Firm*—Alix, Yale & Ristas, LLP

(57) **CLAIM**

The ornamental design for the protective pad, as shown and described.

DESCRIPTION

FIG. 1 is a front view of a protective pad showing my new design;

FIG. 2 is a top plan view of the protective pad of FIG. 1;

FIG. 3 is a left side view of the protective pad of FIG. 1;

FIG. 4 is a right side view of the protective pad of FIG. 1;

FIG. 5 is a rear view of the protective pad of FIG. 1; and,

FIG. 6 is a bottom plan view of the protective pad of FIG. 1.

The intermittent line in the drawings represents stitching and forms part of the claim.

1 Claim, 3 Drawing Sheets

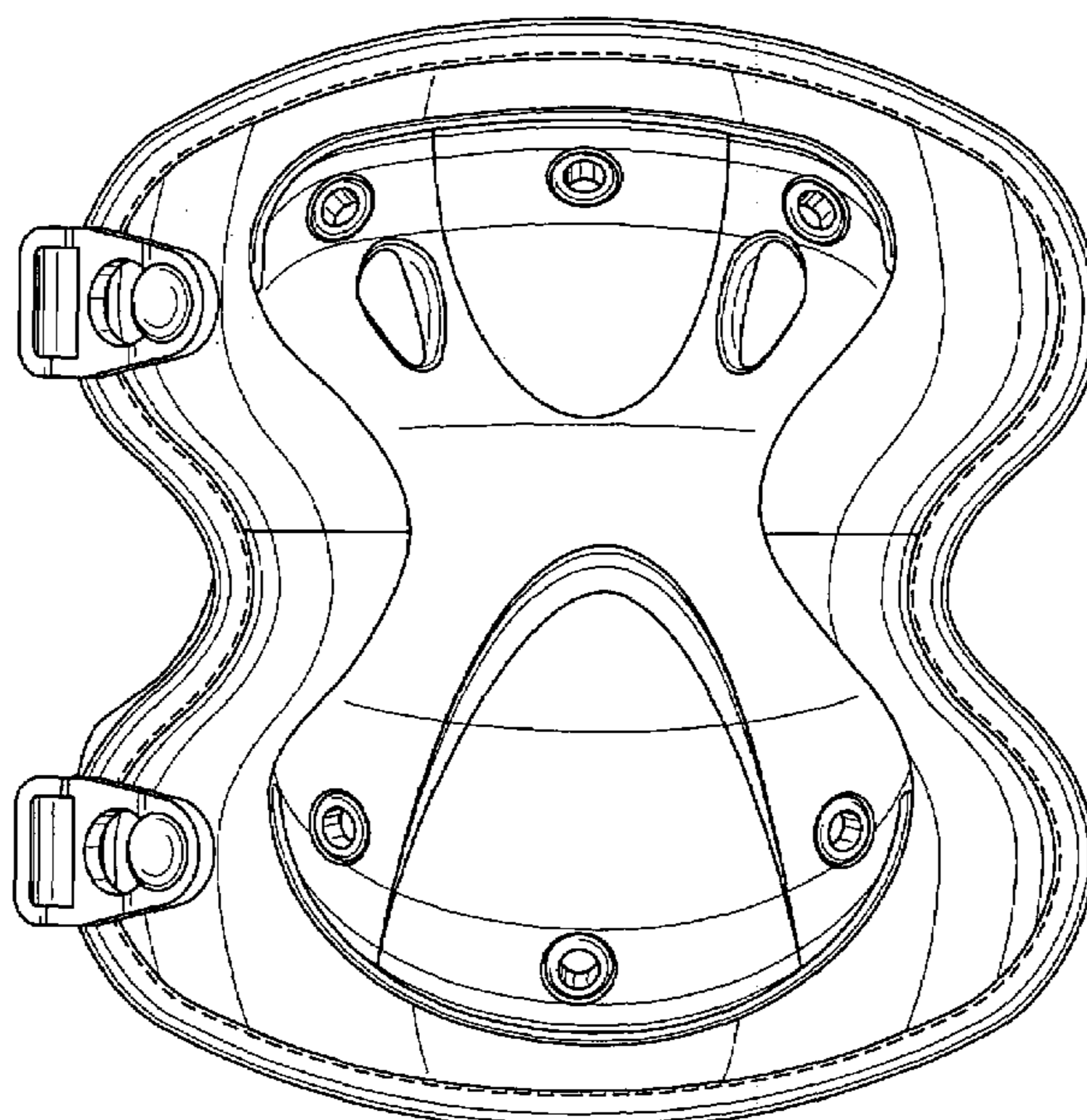

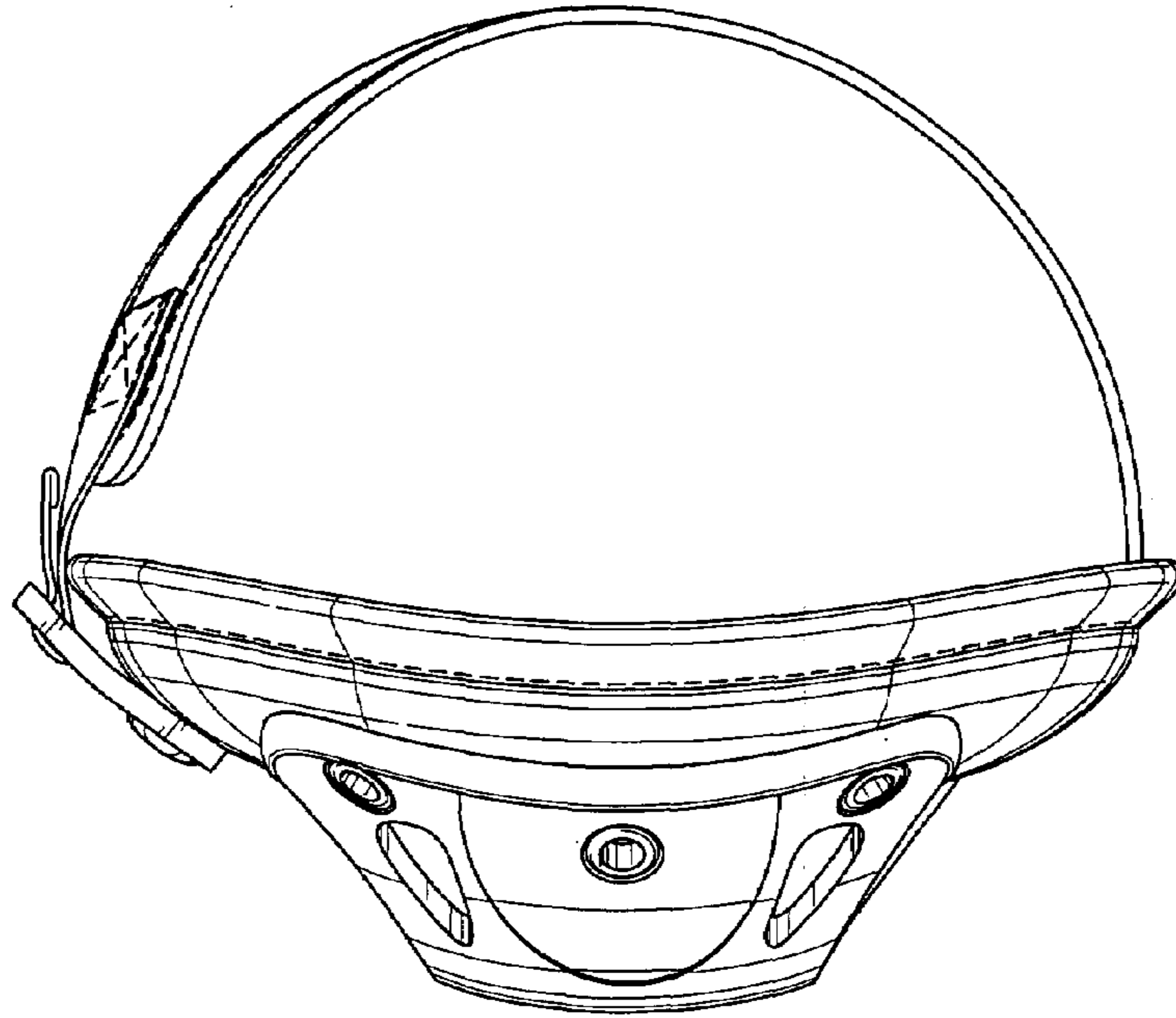

FIG. 2

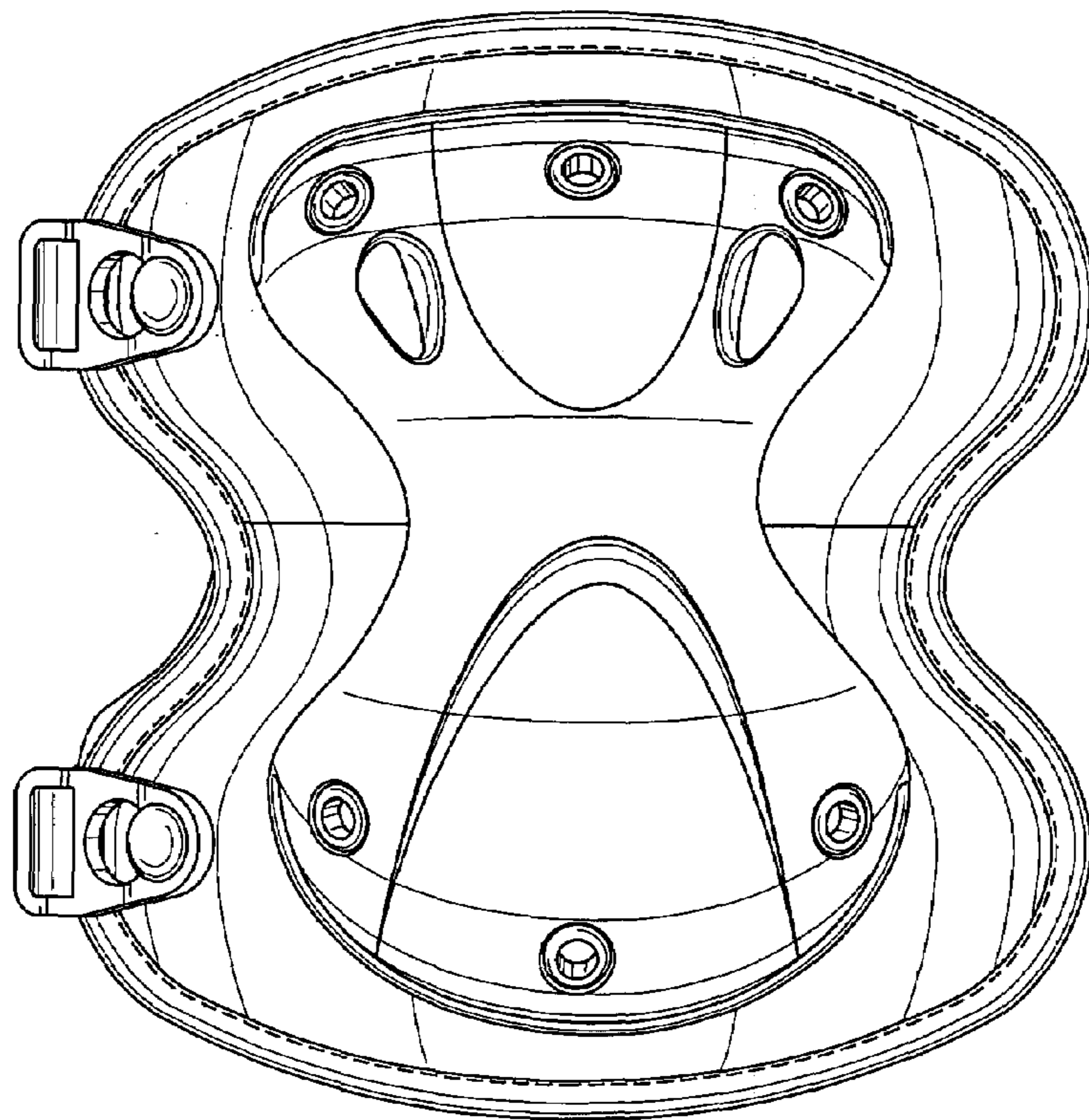

FIG. 1

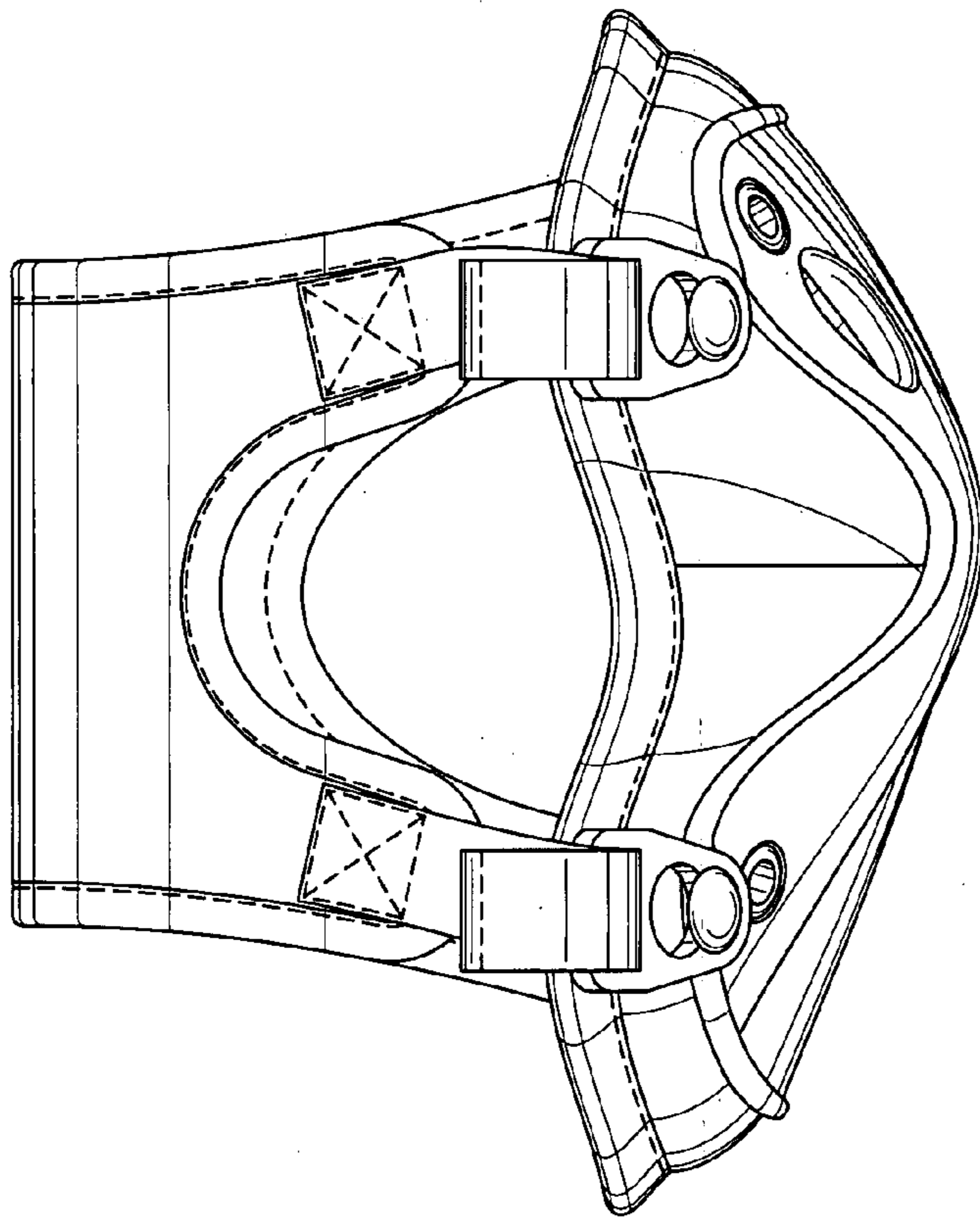

FIG. 3

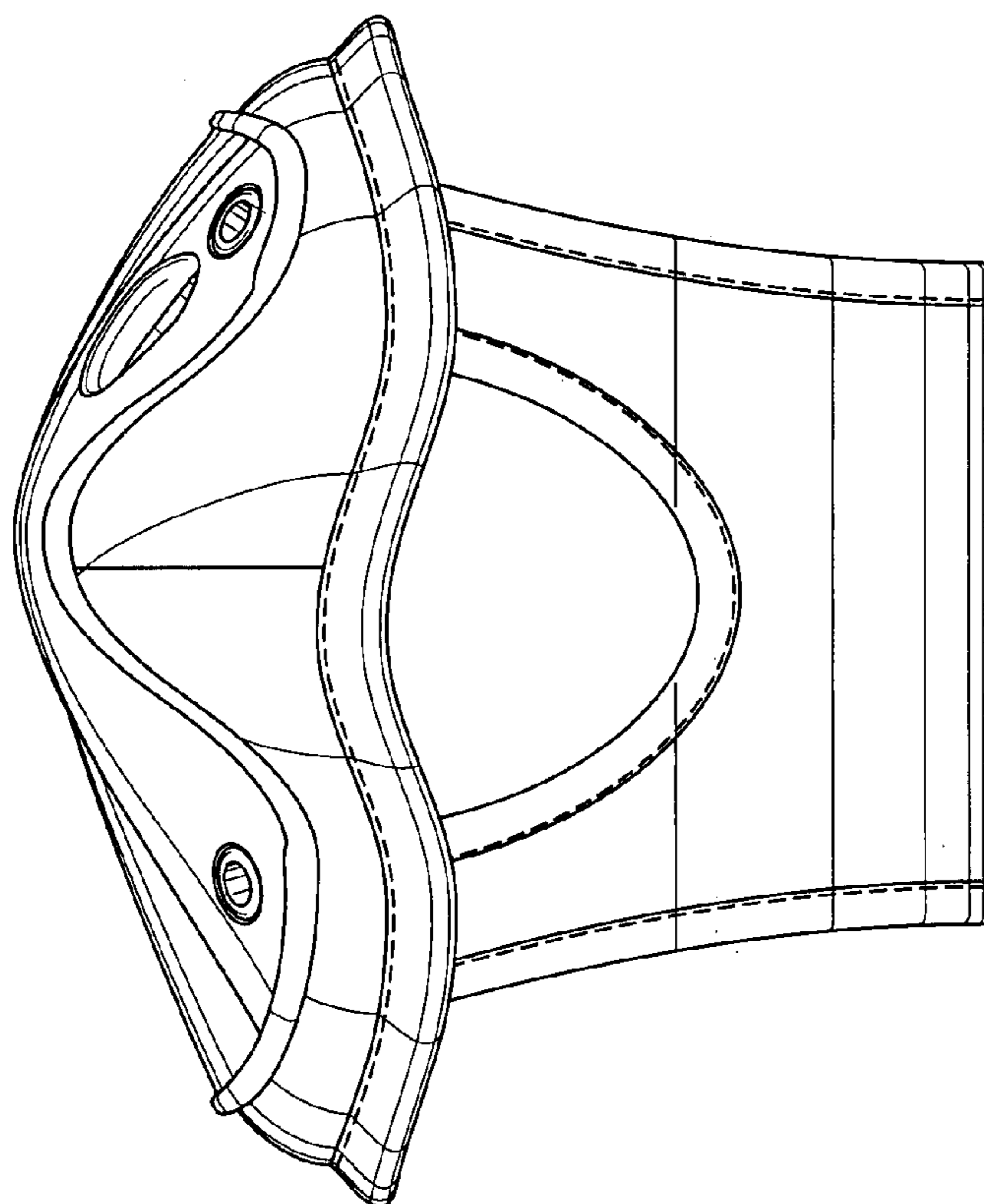

FIG. 4

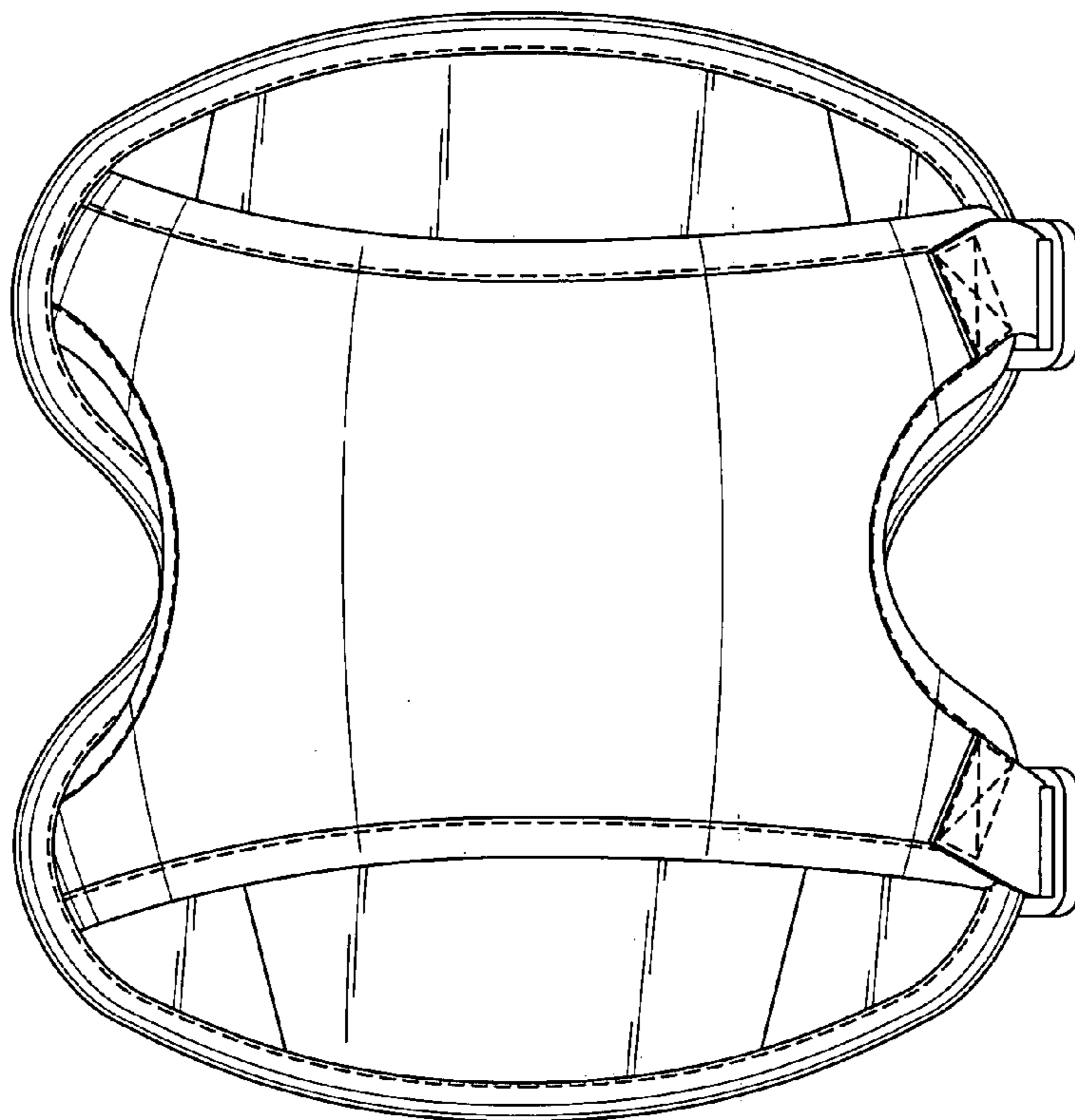

FIG. 5

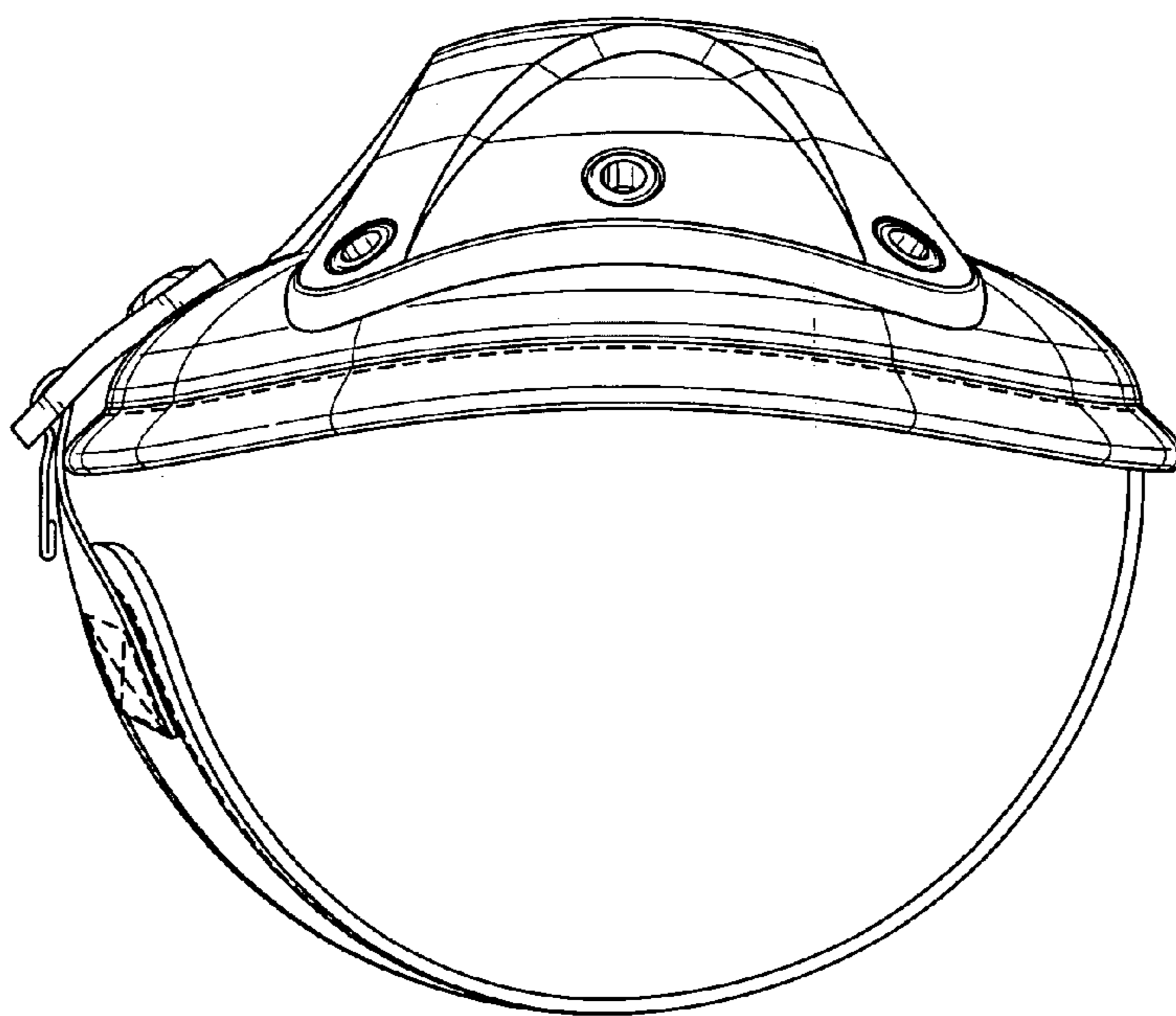

FIG. 6