



US00D553229S

(12) **United States Design Patent**
Song et al.

(10) **Patent No.:** **US D553,229 S**

(45) **Date of Patent:** **** Oct. 16, 2007**

(54) **DEHUMIDIFIER**

(75) Inventors: **Hyung Kyu Song**, Suwon (KR); **Min Jung Kang**, Bucheon-Si (KR)

(73) Assignee: **Samsung Electronics Co., Ltd.**,
Kyungki-Do (KR)

(**) Term: **14 Years**

(21) Appl. No.: **29/264,504**

(22) Filed: **Aug. 11, 2006**

(51) **LOC (8) Cl.** **23-04**

(52) **U.S. Cl.** **D23/359**

(58) **Field of Classification Search** D23/359,
D23/364, 355, 356, 360, 362, 352, 366, 369,
D23/332, 333, 335, 336, 342; 422/120, 122;
55/356, 473, 504; 210/497.1; 96/97; D14/188,
D14/170, 172

See application file for complete search history.

(56) **References Cited**

U.S. PATENT DOCUMENTS

- D310,412 S * 9/1990 Fukumoto et al. D23/359
- D323,210 S * 1/1992 Wortham D23/364
- D335,339 S * 5/1993 Glucksman et al. D23/356
- D377,523 S * 1/1997 Marvin et al. D23/364
- D401,318 S * 11/1998 Rakocy D23/364
- D411,879 S * 7/1999 Stanek et al. D23/356

- D416,614 S * 11/1999 Bellil et al. D23/364
- D429,805 S * 8/2000 Hyon D23/359
- D430,928 S * 9/2000 Lafond et al. D23/364
- D431,643 S * 10/2000 Krauss et al. D23/356
- D433,493 S * 11/2000 Runyan et al. D23/364
- D440,644 S * 4/2001 Potnis et al. D23/359
- D529,161 S * 9/2006 De'Longhi D23/364

* cited by examiner

Primary Examiner—Louis Zarfaz

Assistant Examiner—David G. Muller

(74) *Attorney, Agent, or Firm*—Ladas and Parry LLP

(57) **CLAIM**

We claim the ornamental design for a dehumidifier, as shown.

DESCRIPTION

FIG. 1 is a top, front, and left side perspective view of a dehumidifier showing our new design;

FIG. 2 is a front elevational view thereof;

FIG. 3 is a rear elevational view thereof;

FIG. 4 is a right side elevational view thereof;

FIG. 5 is a left side elevational view thereof;

FIG. 6 is a top plan view thereof; and,

FIG. 7 is a bottom plan view thereof.

1 Claim, 6 Drawing Sheets

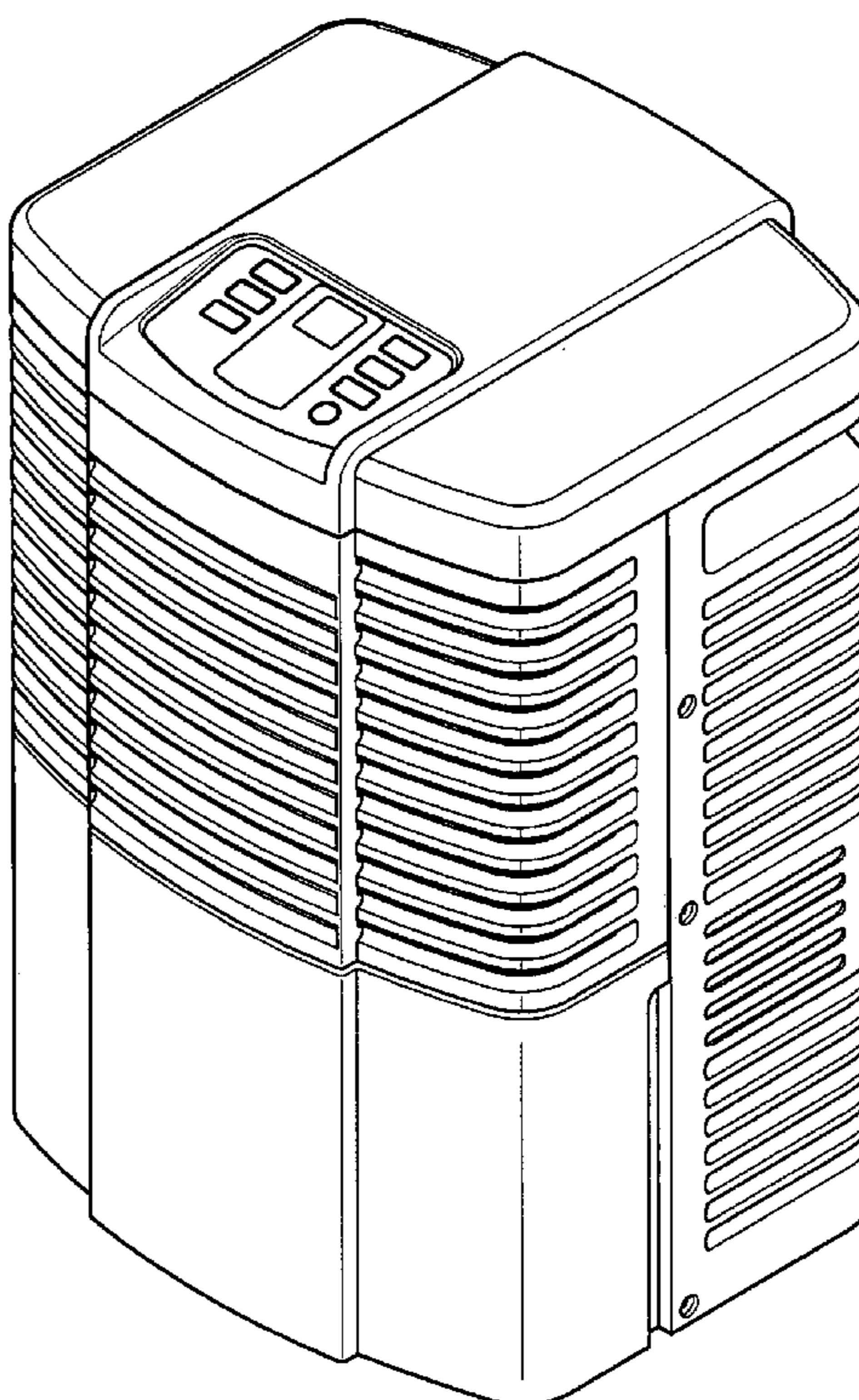

FIG. 1

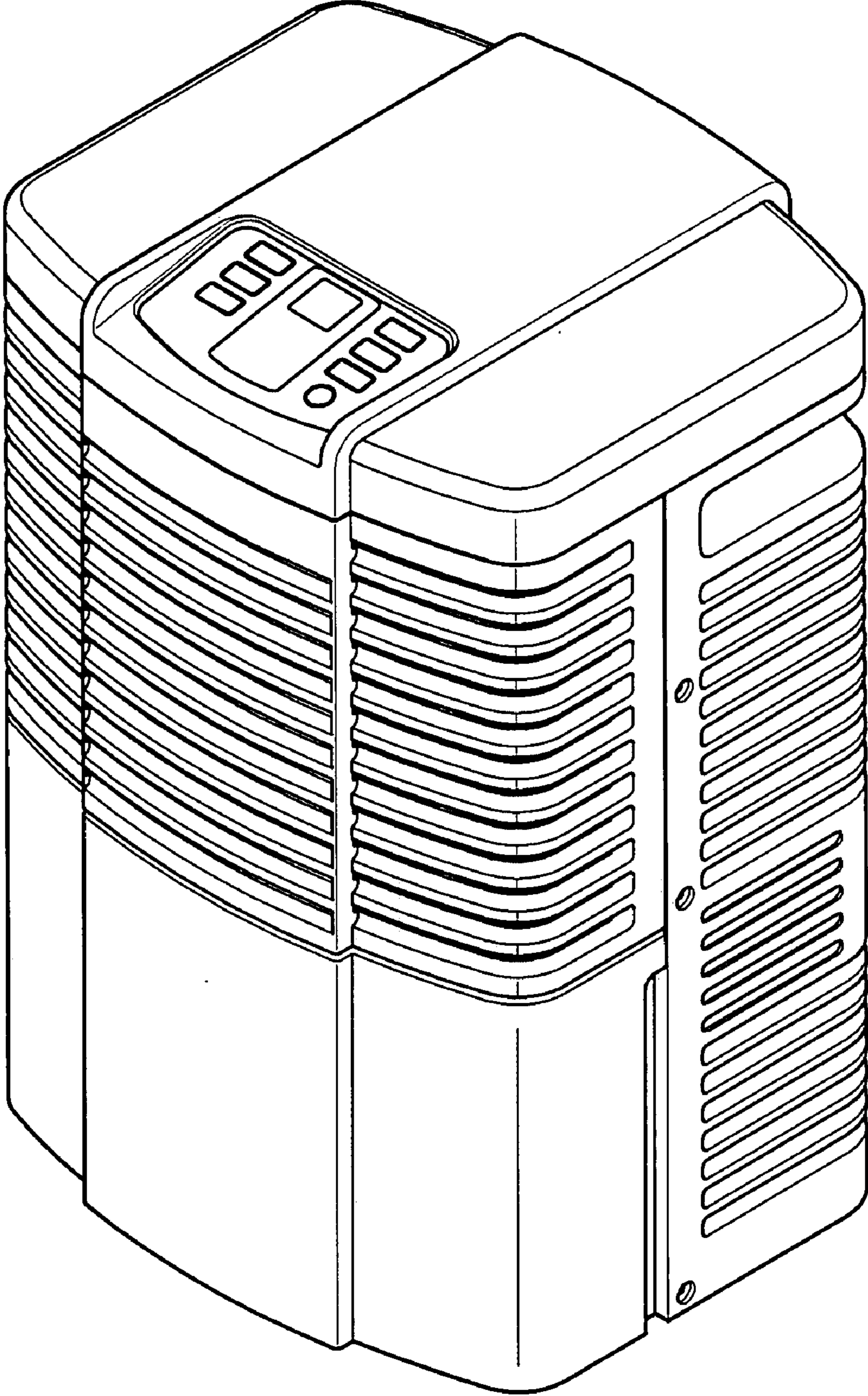

FIG. 2

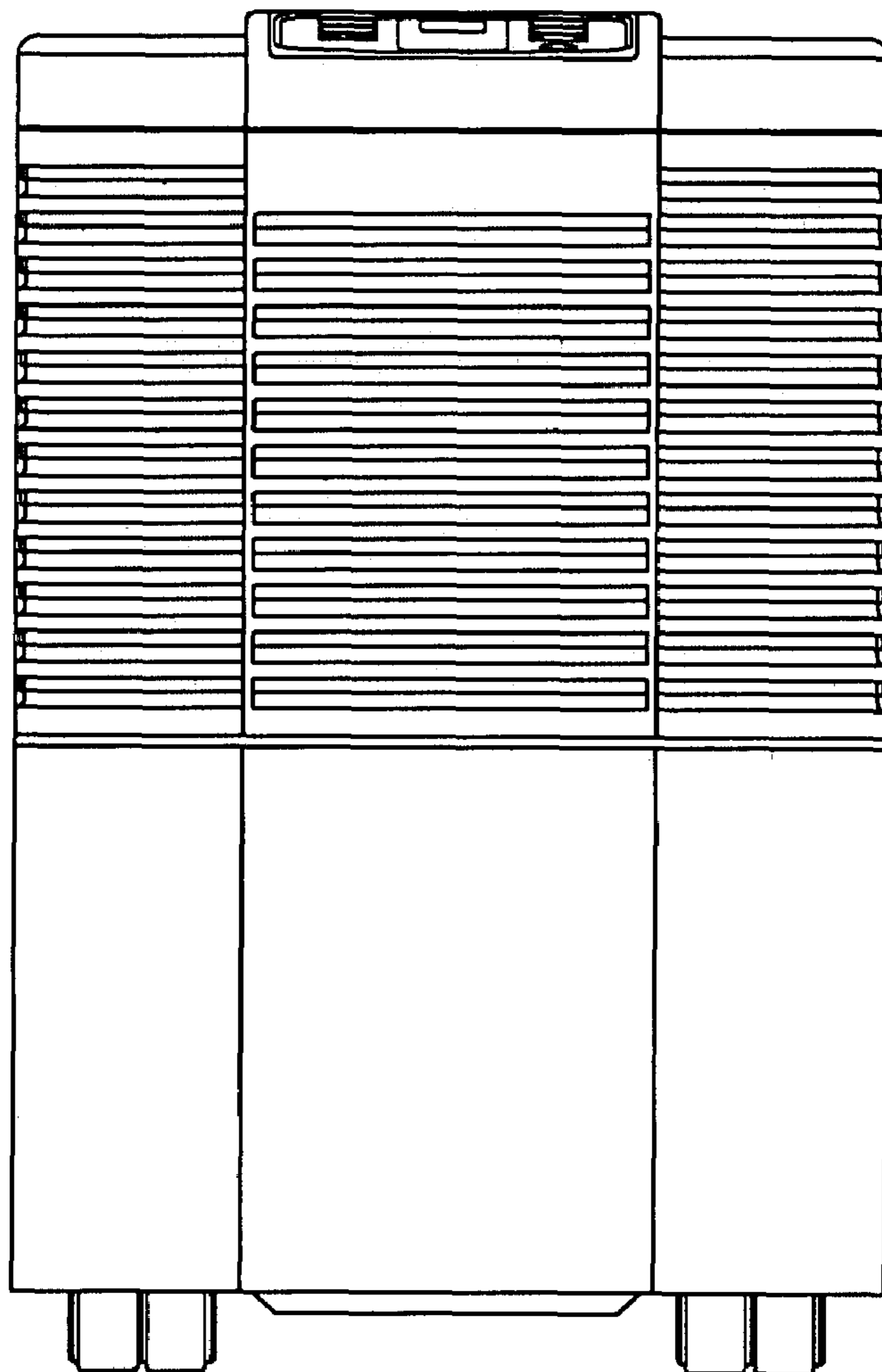

FIG. 3

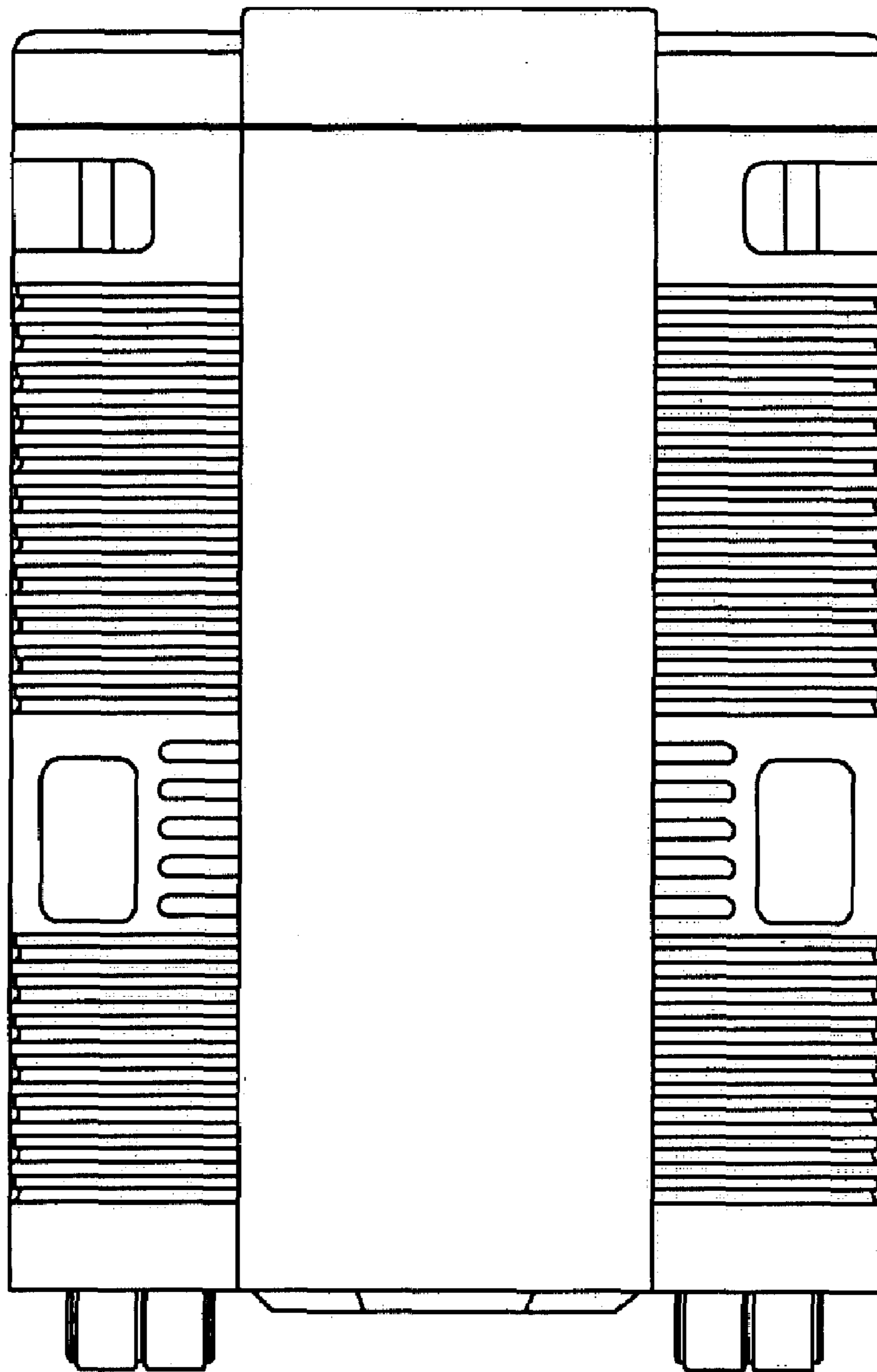

FIG. 4

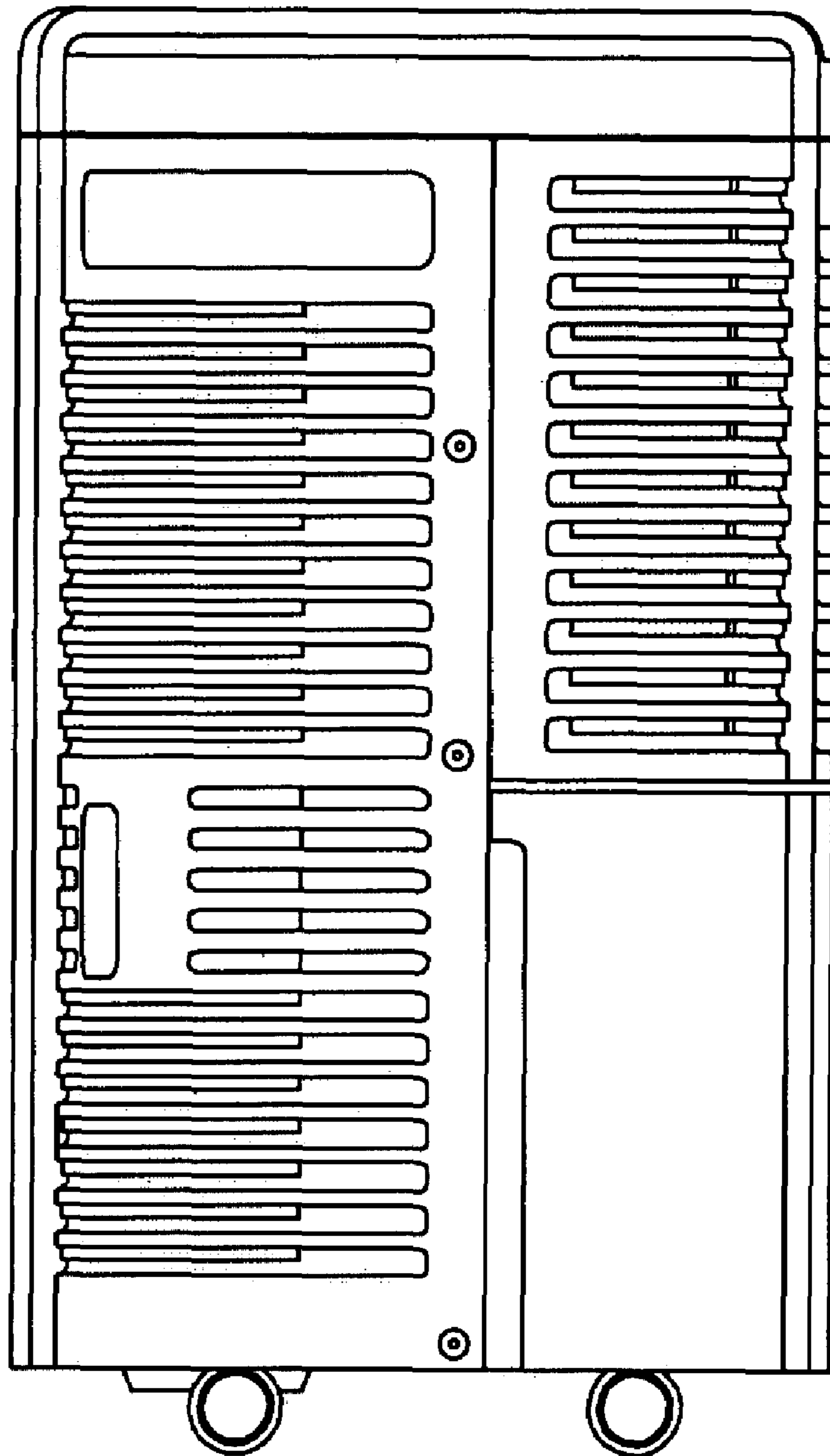

FIG. 5

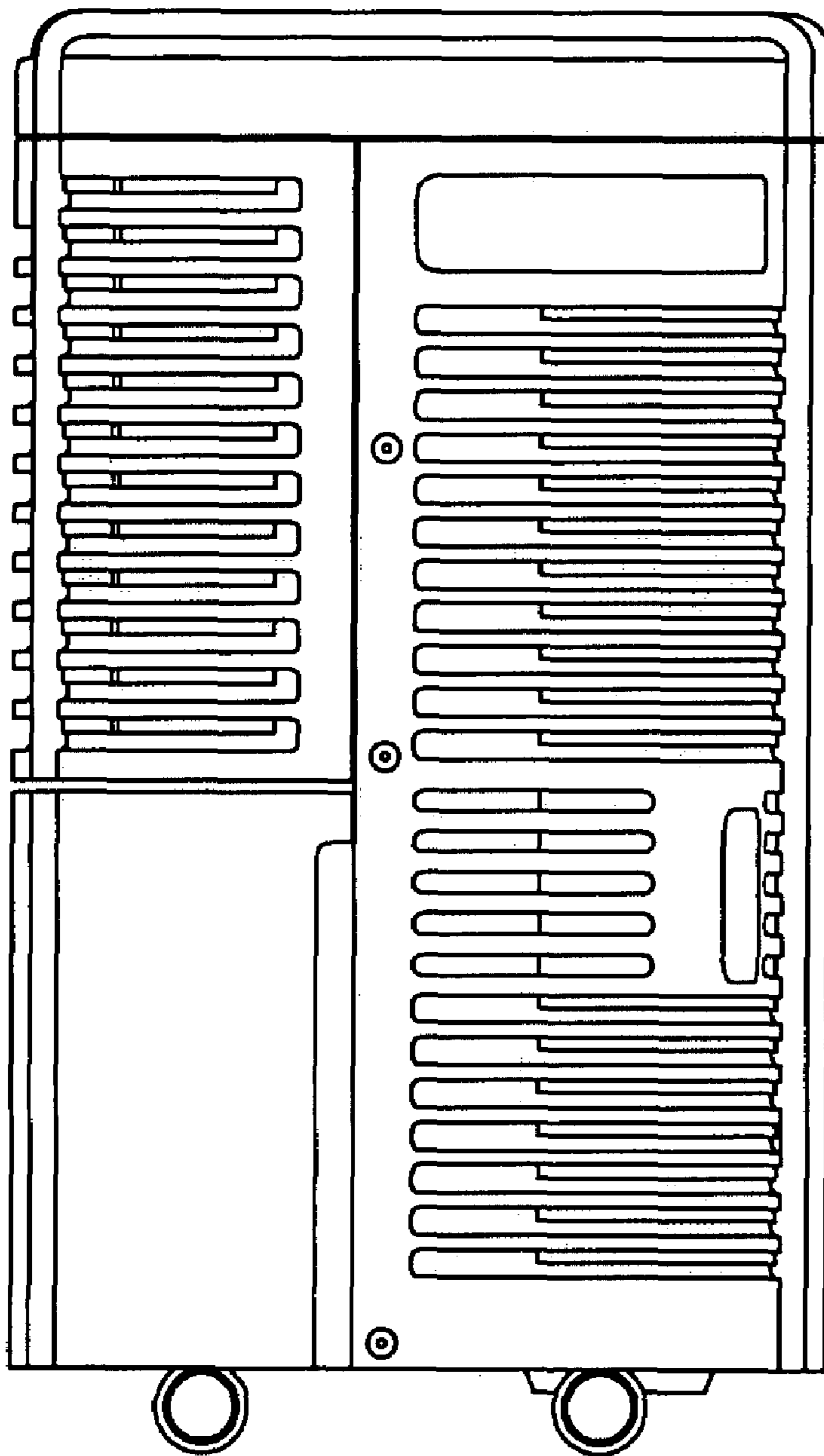

FIG. 6

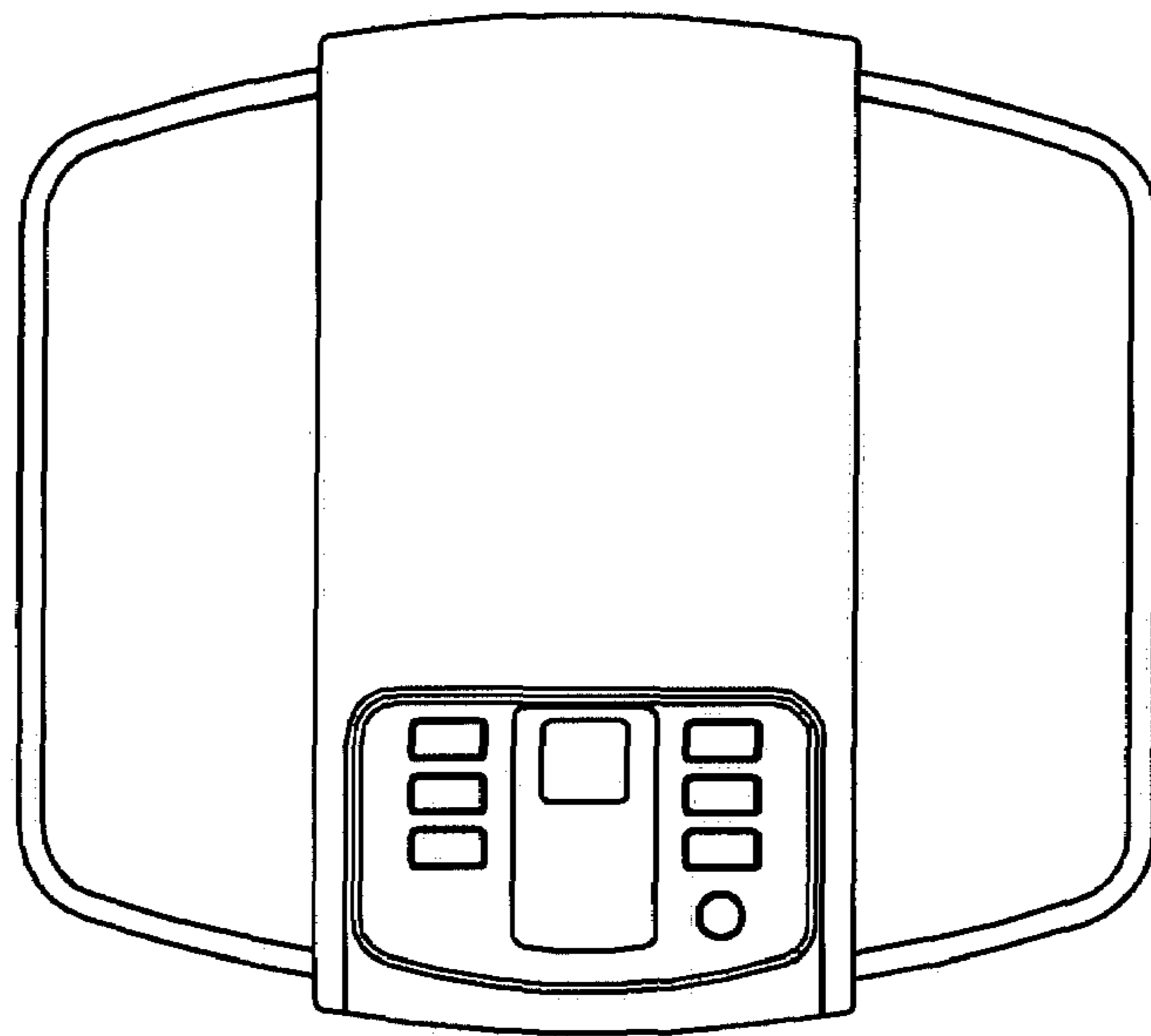

FIG. 7

