



US00D553218S

(12) **United States Design Patent**  
**Keegan**

(10) **Patent No.:** **US D553,218 S**

(45) **Date of Patent:** **\*\* Oct. 16, 2007**

(54) **SWIM EXERCISE FIN**

(75) Inventor: **Steven Keegan**, Los Angeles, CA (US)

(73) Assignee: **Warnaco Swimwear Incorporated**,  
Commerce, CA (US)

(\*\*) Term: **14 Years**

(21) Appl. No.: **29/225,324**

(22) Filed: **Mar. 15, 2005**

(51) **LOC (8) Cl.** ..... **21-01**

(52) **U.S. Cl.** ..... **D21/806**

(58) **Field of Classification Search** ..... D21/769,  
D21/770, 801, 803, 804, 806, 807, 810; 114/363;  
D2/731, 732; 441/55, 56, 58, 60, 61-66,  
441/68, 69, 72-75, 79

See application file for complete search history.

(56) **References Cited**

**U.S. PATENT DOCUMENTS**

D277,595	S	*	2/1985	Simpson	.....	D21/806
4,775,343	A	*	10/1988	Lamont et al.	.....	441/64
4,813,668	A	*	3/1989	Solloway	.....	482/111
D348,917	S	*	7/1994	Bedortha et al.	.....	D21/678
D349,552	S	*	8/1994	Fleming	.....	D21/806
5,374,210	A	*	12/1994	Sardella et al.	.....	441/64
5,975,973	A	*	11/1999	Fleming	.....	441/64
2004/0029465	A1	*	2/2004	Hull	.....	441/64

**OTHER PUBLICATIONS**

Performance Diver Catalog, Summer 1994, p. 30, 'IST Pro Flex Dive Fin' and 'Diver-Power Performance Fins', located at the top of the page.\*

Performance Diver Catalog, Summer 1994, p. 31, 'Explorer Snorkel', located at the top of the page.\*

Dive—Wallin's Dive Center Catalog 2002, p. 13, 'Bi-Vent Fins', located at the top of the page.\*

\* cited by examiner

*Primary Examiner*—Caron D. Veynar

*Assistant Examiner*—Zenita I. Bennett

(74) *Attorney, Agent, or Firm*—Katten Muchin Rosenman LLP

(57) **CLAIM**

The ornamental design for a swim exercise fin, as shown.

**DESCRIPTION**

FIG. 1 is a perspective view of a swim exercise fin showing my new design;

FIG. 2 is a front elevational view thereof;

FIG. 3 is a rear elevational view thereof;

FIG. 4 is a left elevational view thereof;

FIG. 5 is a right elevational view thereof;

FIG. 6 is a top plan view thereof; and,

FIG. 7. is a bottom plan view thereof.

**1 Claim, 6 Drawing Sheets**

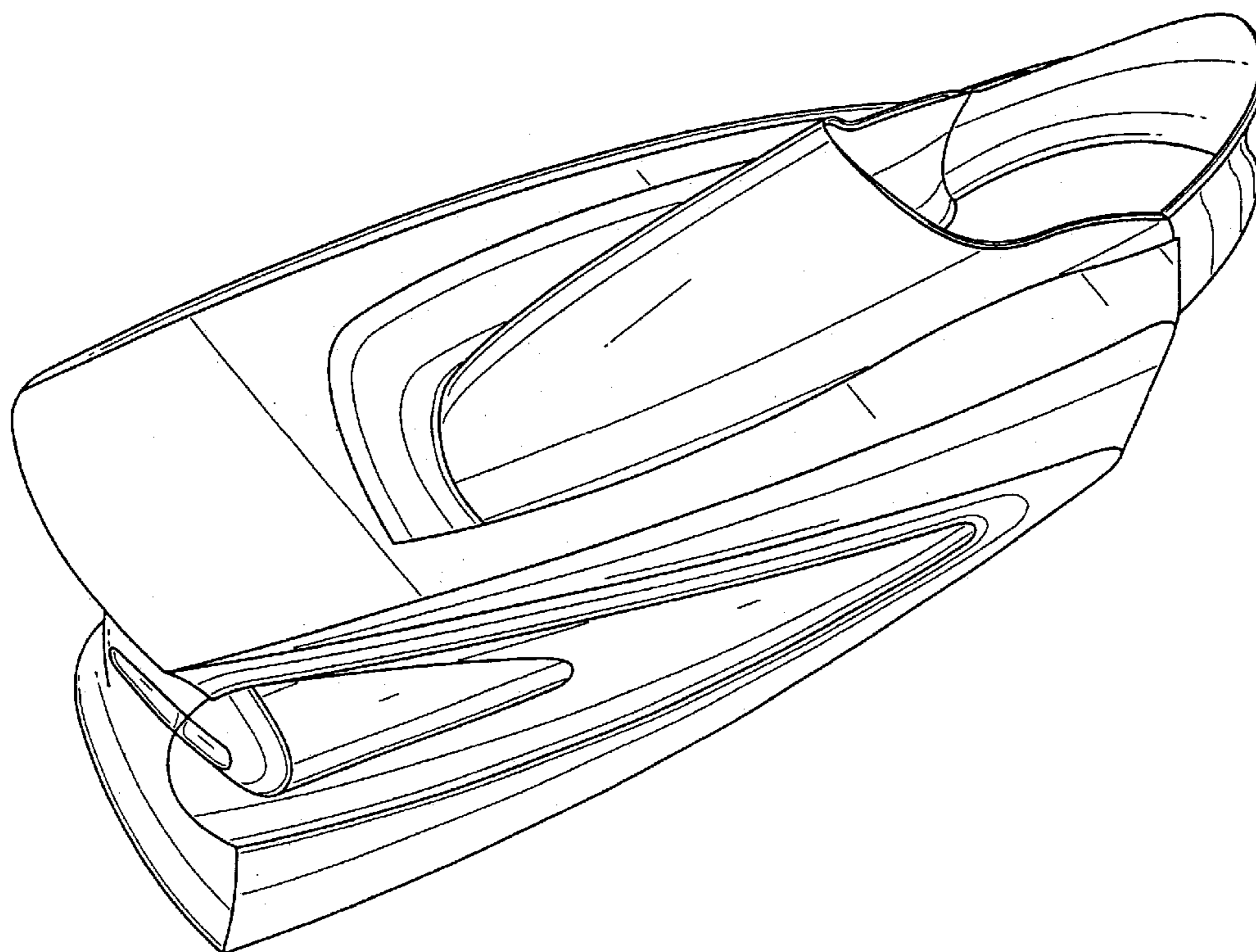

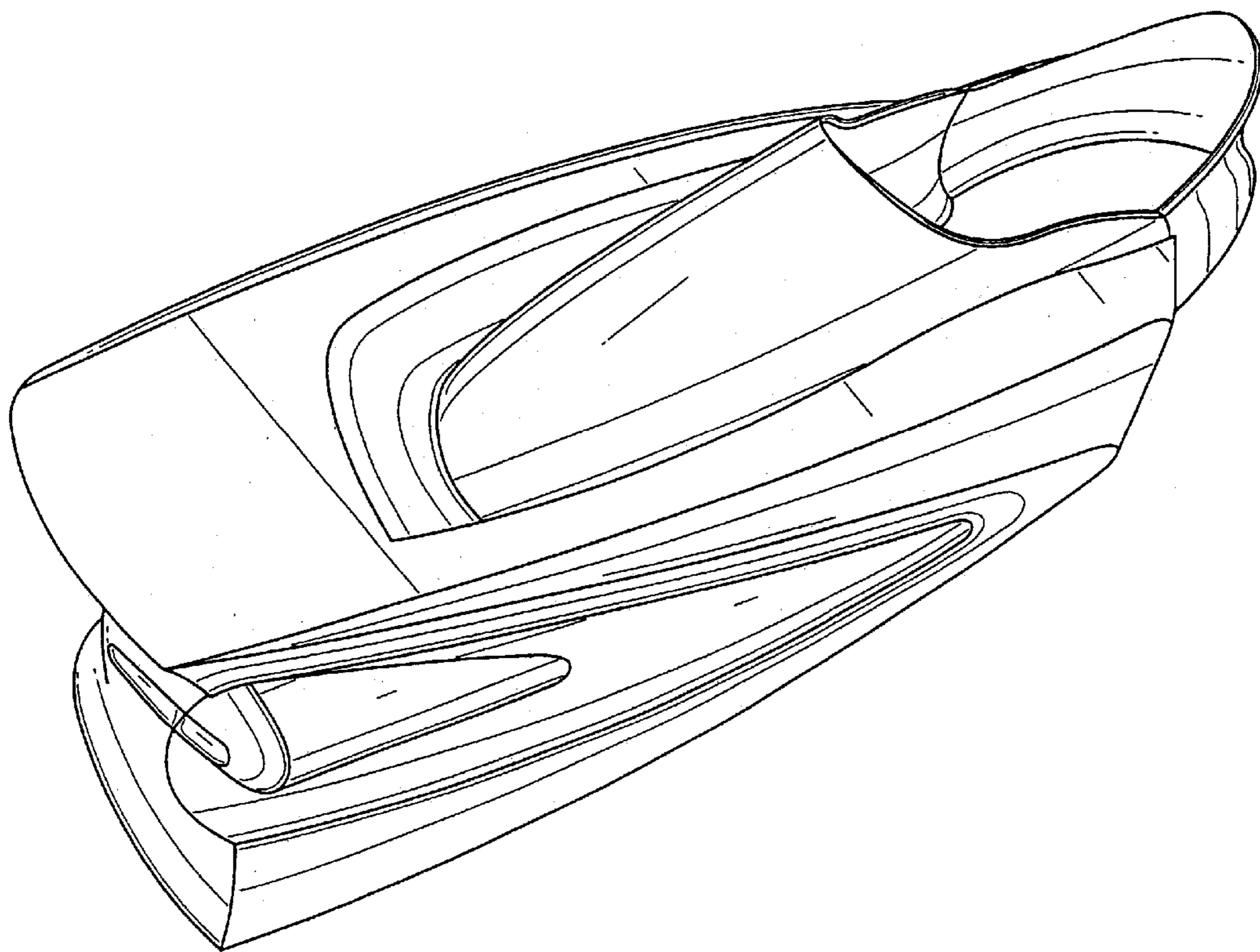

FIG. 1

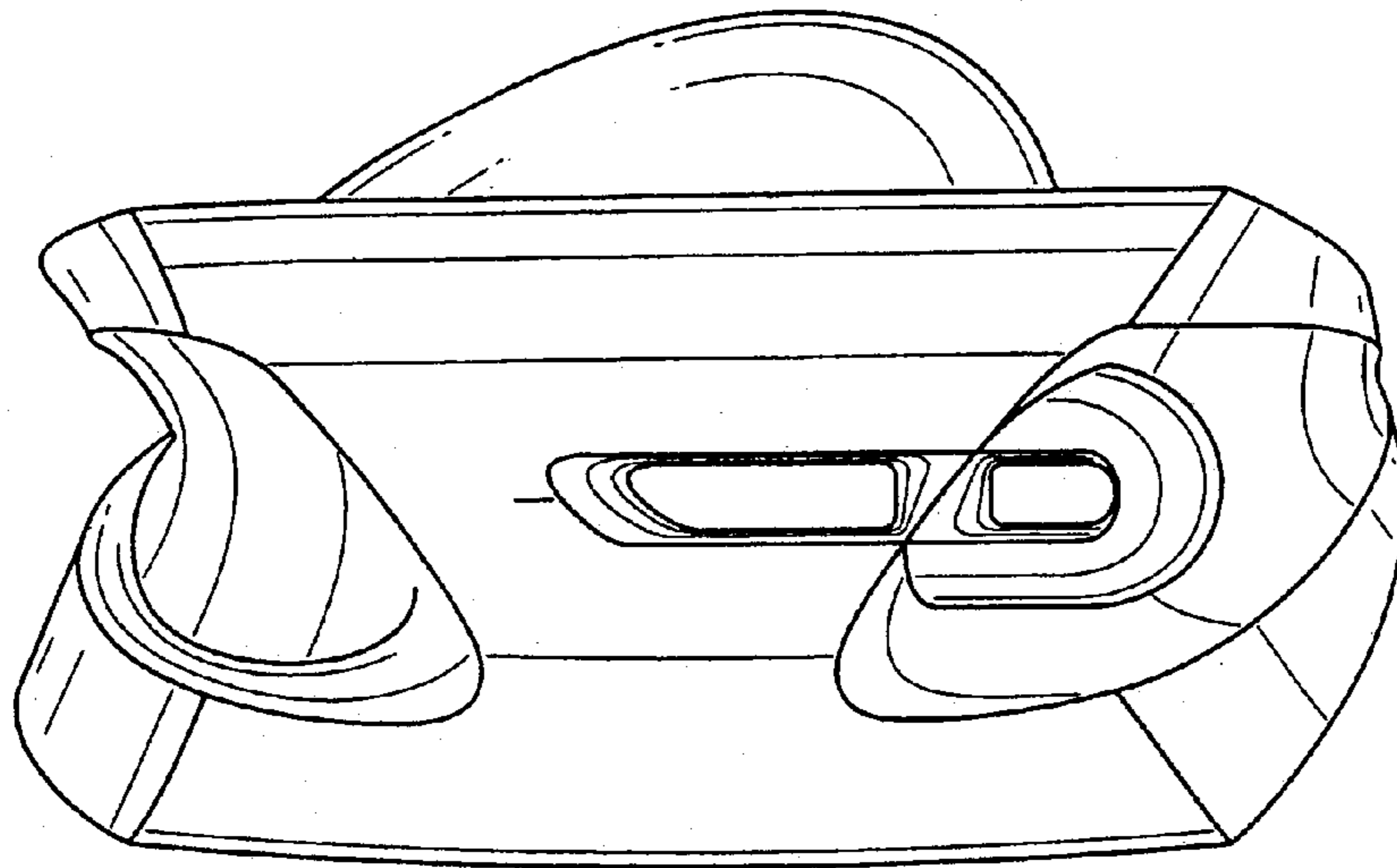

FIG. 2

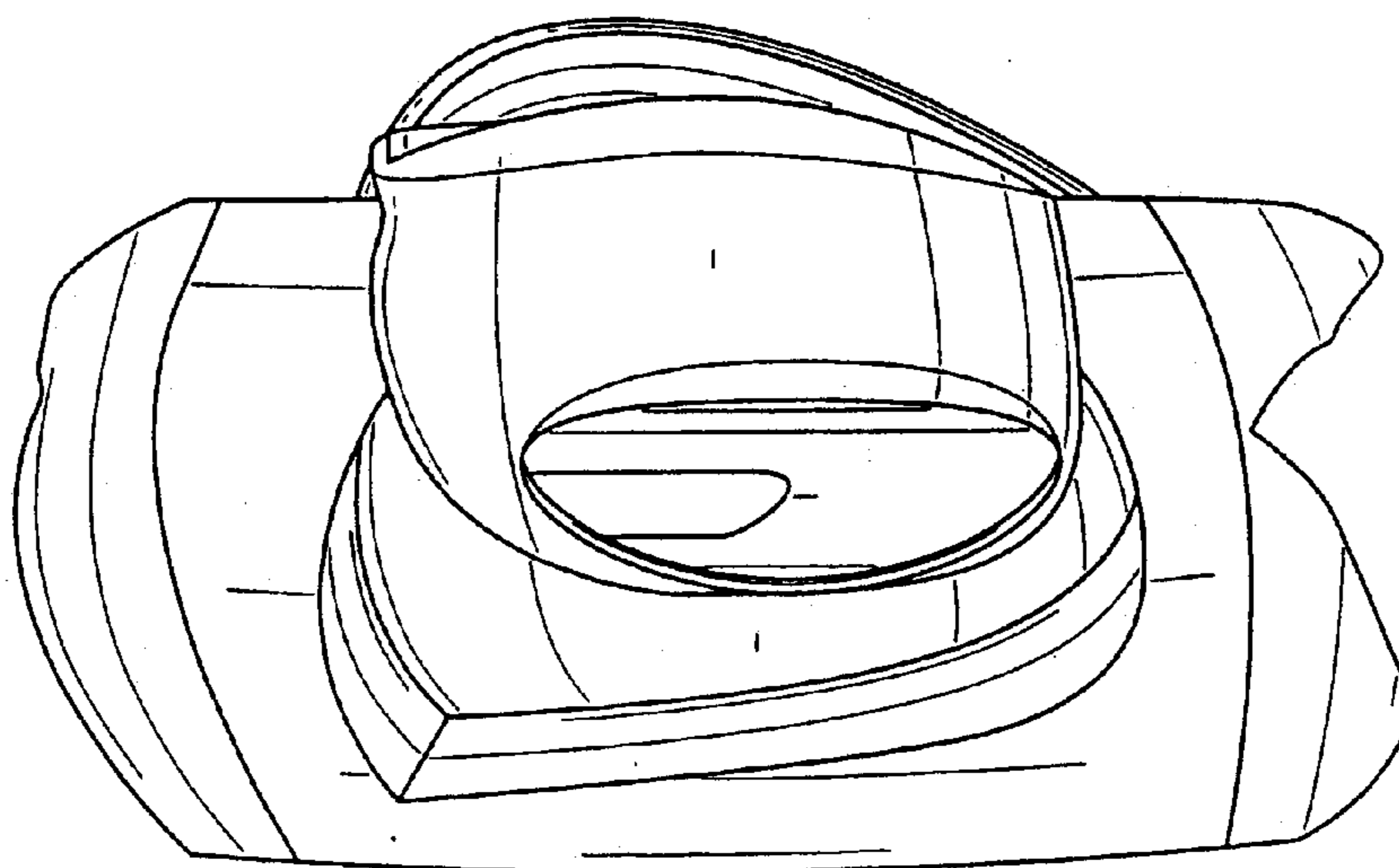

FIG. 3

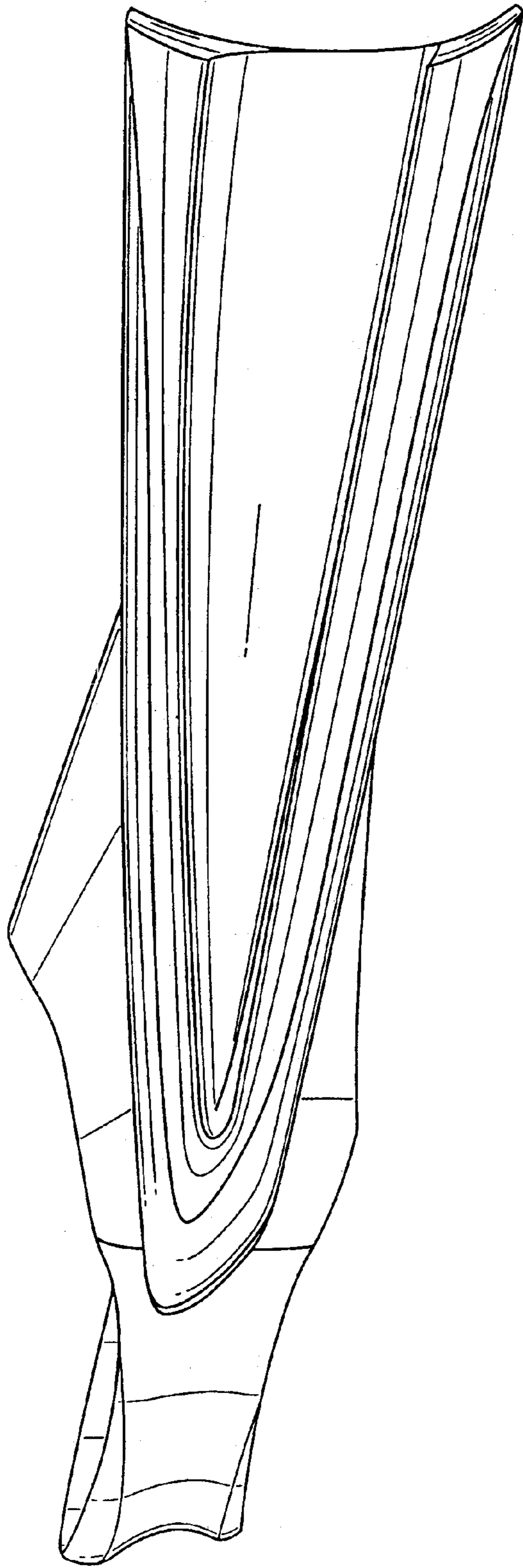

FIG. 4

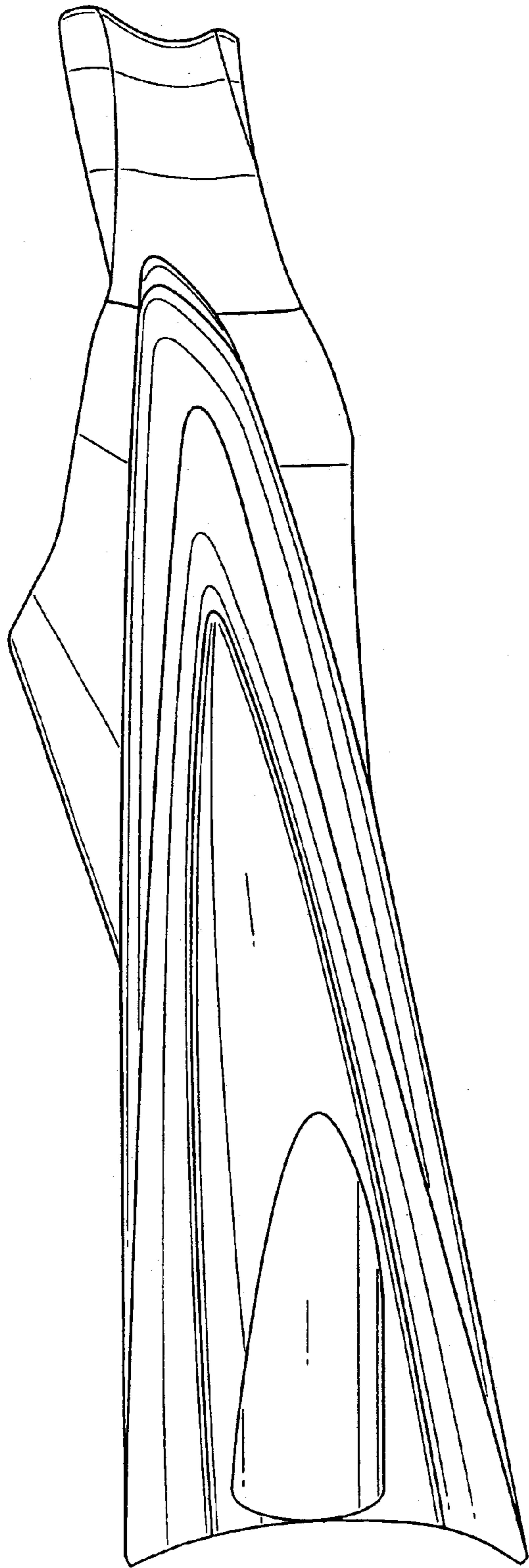

FIG. 5

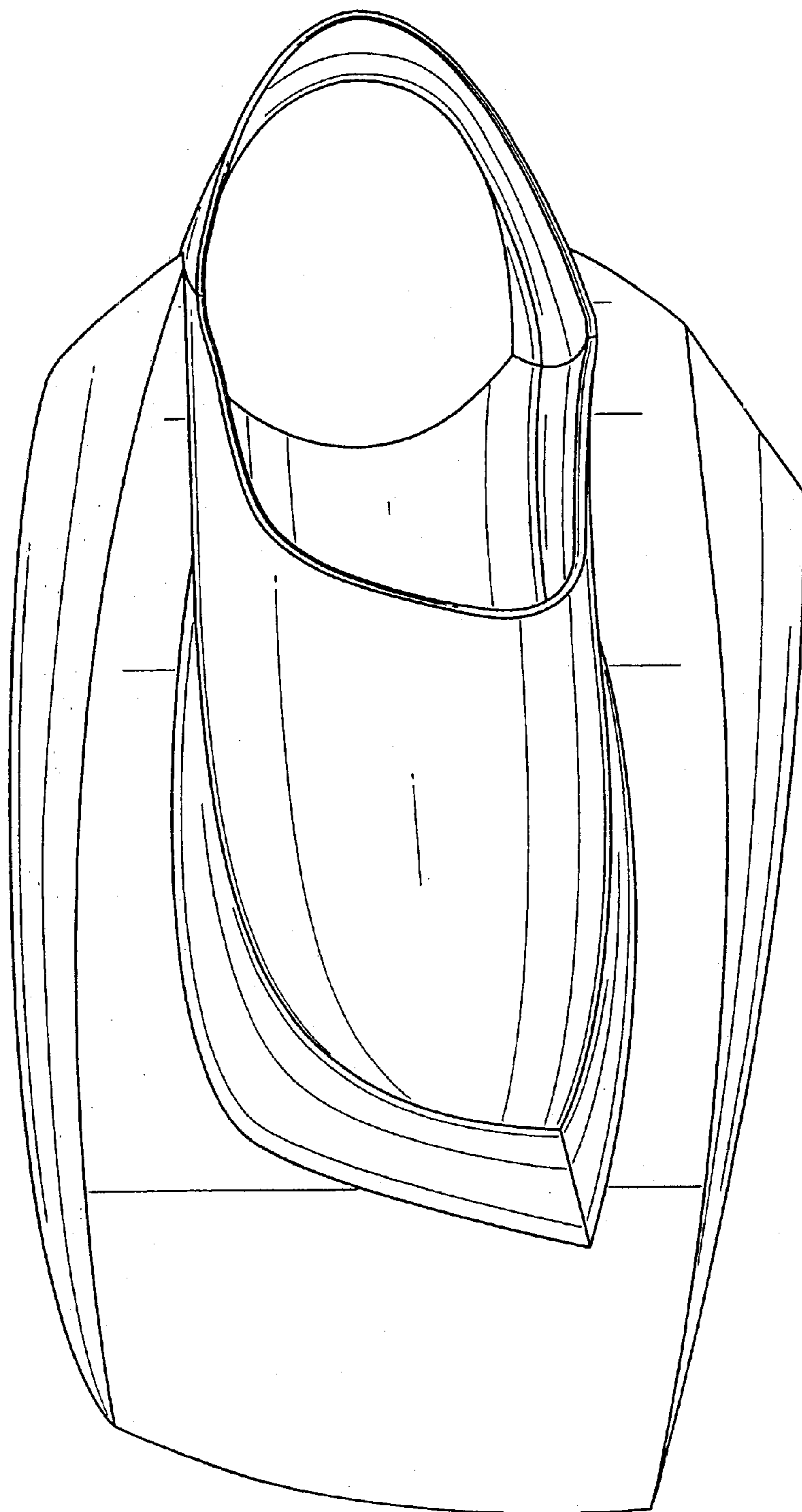

FIG. 6

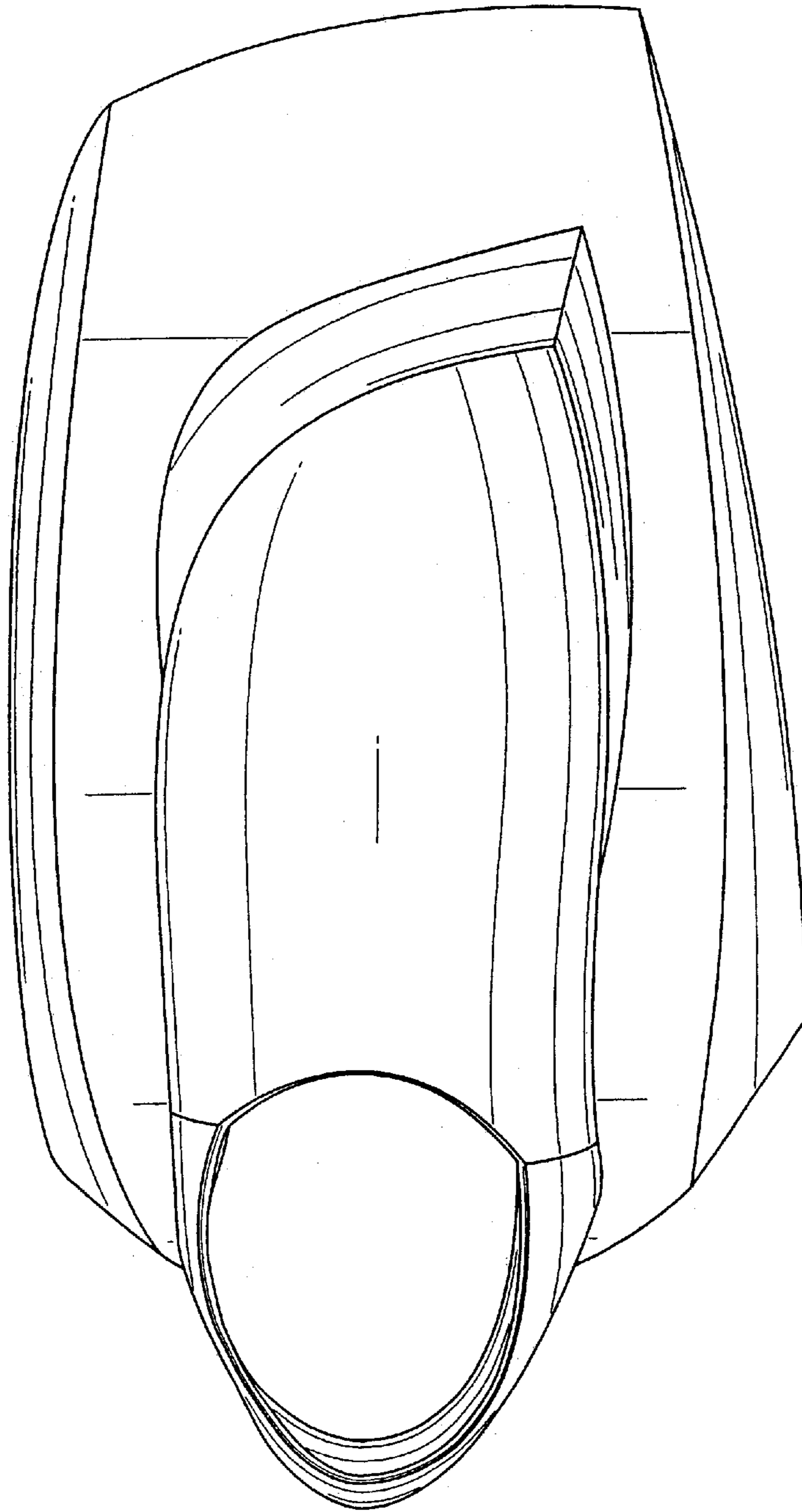

FIG. 7