

US00D553002S

(12) **United States Design Patent** (10) **Patent No.:** **US D553,002 S**
Petek (45) **Date of Patent:** **** Oct. 16, 2007**

(54) **CONTAINER WITH A CLIP FOR AEROSOL CANS**

(75) Inventor: **Josef Petek**, Flawil (CH)

(73) Assignee: **e+h Services AG**, Daeniken SO (CH)

(**) Term: **14 Years**

(21) Appl. No.: **29/221,746**

(22) Filed: **Jan. 18, 2005**

D307,648 S * 5/1990 Arrington D29/126
D308,474 S * 6/1990 Seager D9/689
D316,033 S 4/1991 Czech
5,018,647 A * 5/1991 Abplanalf 222/108
D337,054 S * 7/1993 Chong D9/448
D344,230 S 2/1994 Bertolini
D349,846 S * 8/1994 Gray D9/692
5,348,193 A 9/1994 Bruckner et al.
D354,686 S 1/1995 Ricci
5,458,263 A 10/1995 Ciammitti et al.
D381,261 S 7/1997 Crawford

(Continued)

Related U.S. Application Data

(62) Division of application No. 29/188,012, filed on Aug. 11, 2003, now Pat. No. Des. 511,974.

(30) **Foreign Application Priority Data**

Feb. 11, 2003 (CH) 129358

(51) **LOC (8) Cl.** **09-01**

(52) **U.S. Cl.** **D9/682**

(58) **Field of Classification Search** D9/522,
D9/538, 682, 686-691, 726; 222/260, 321.3,
222/321.7, 383.1, 556

See application file for complete search history.

(56) **References Cited**

U.S. PATENT DOCUMENTS

2,652,707 A 9/1953 Reilly, Jr. et al.
D188,882 S * 9/1960 Jokelson D9/688
3,161,330 A 12/1964 Sagarin et al.
3,429,484 A * 2/1969 Baldwin 222/402.13
3,580,432 A * 5/1971 Brooks 222/402.13
3,987,942 A * 10/1976 Morane et al. 222/402.15
D244,424 S 5/1977 Petterson
4,077,548 A * 3/1978 Beard 222/321.8
4,077,549 A * 3/1978 Beard 222/321.8
4,132,359 A 1/1979 Nozawa
4,185,776 A 1/1980 Nozawa
D285,538 S 9/1986 Trumstedt
4,819,832 A 4/1989 Lawson
D301,773 S * 6/1989 Murakami et al. D28/91.1
D307,542 S * 5/1990 De Montgailhard D9/687

Primary Examiner—Stella Reid
Assistant Examiner—Rashida C. McCoy

(74) *Attorney, Agent, or Firm*—Knobbe, Martens, Olson & Bear LLP

(57) **CLAIM**

The ornamental designs for a container with a clip for aerosol cans, as shown and described.

DESCRIPTION

FIG. 1 is the left side view of a container with a clip for aerosol cans, showing my new design;
FIG. 2 is a front view thereof;
FIG. 3 is a bottom view thereof;
FIG. 4 is a top view thereof;
FIG. 5 is an elevated perspective view thereof;
FIG. 6 is an elevated rear perspective view thereof;
FIG. 7 is a right side view thereof;
FIG. 8 is a rear view thereof;
FIG. 9 is a left side view of a second embodiment of a container with a clip for aerosol cans;
FIG. 10 is a front view of FIG. 9;
FIG. 11 is a bottom view of FIG. 9;
FIG. 12 is a top view of FIG. 9;
FIG. 13 is an elevated perspective front view of FIG. 9;
FIG. 14 is an elevated rear perspective view of FIG. 9;
FIG. 15 is a right side view of FIG. 9; and,
FIG. 16 is a rear view of FIG. 9.

1 Claim, 8 Drawing Sheets

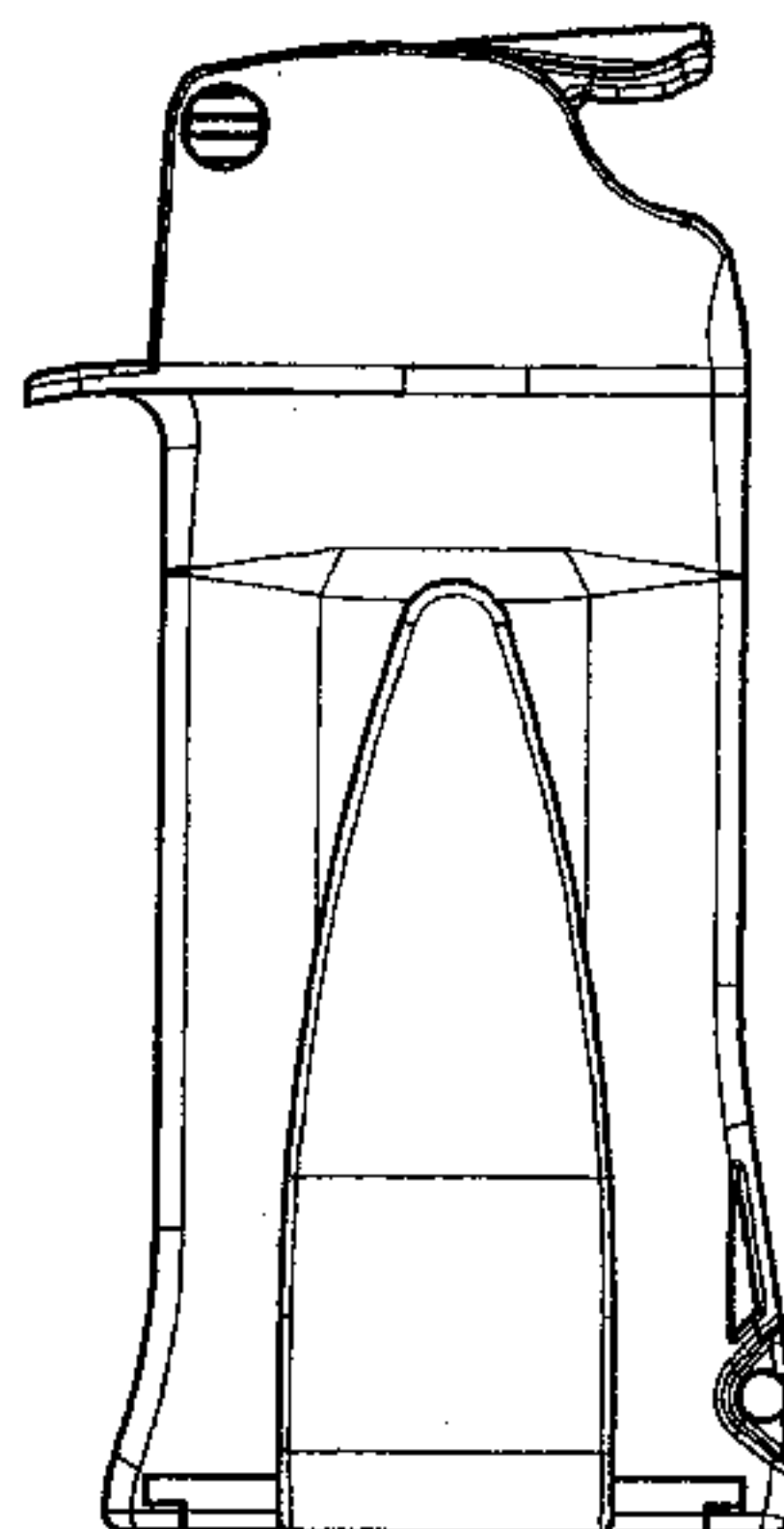

US D553,002 S

Page 2

U.S. PATENT DOCUMENTS							
5,755,218	A	5/1998	Johansson et al.	6,439,432	B1	8/2002	Park
5,788,123	A	8/1998	Hackmann et al.	D471,973	S	3/2003	Gillissen et al.
D402,193	S	12/1998	Bell et al.	D473,640	S	4/2003	Cuffaro et al.
D404,294	S	1/1999	Da Baschmakoff	D476,224	S	* 6/2003	de Baschmakoff et al. .. D9/692
D404,305	S	1/1999	Da Baschmakoff	D476,558	S	* 7/2003	Cho et al. D9/685
D405,008	S	* 2/1999	Irwin et al. D9/685	D480,806	S	10/2003	Engelbreth et al.
5,875,936	A	3/1999	Turbett et al.	D481,305	S	10/2003	Walters et al.
D418,404	S	1/2000	Irwin et al.	6,726,016	B2	4/2004	Chen
D438,786	S	* 3/2001	Ghali D9/685	D499,012	S	* 11/2004	Illenberger et al. D9/686
D445,670	S	7/2001	Da Baschmakoff	D524,639	S	* 7/2006	Paas et al. D9/686
D445,685	S	7/2001	Da Baschmakoff	D524,640	S	* 7/2006	Paas et al. D9/686
6,371,333	B2	* 4/2002	Lorscheidt et al. 222/321.9	D525,123	S	* 7/2006	Walters et al. D9/448
6,382,471	B2	* 5/2002	Bonningue et al. 222/321.9	2003/0075571	A1	* 4/2003	Thompson et al. 222/402.15

* cited by examiner

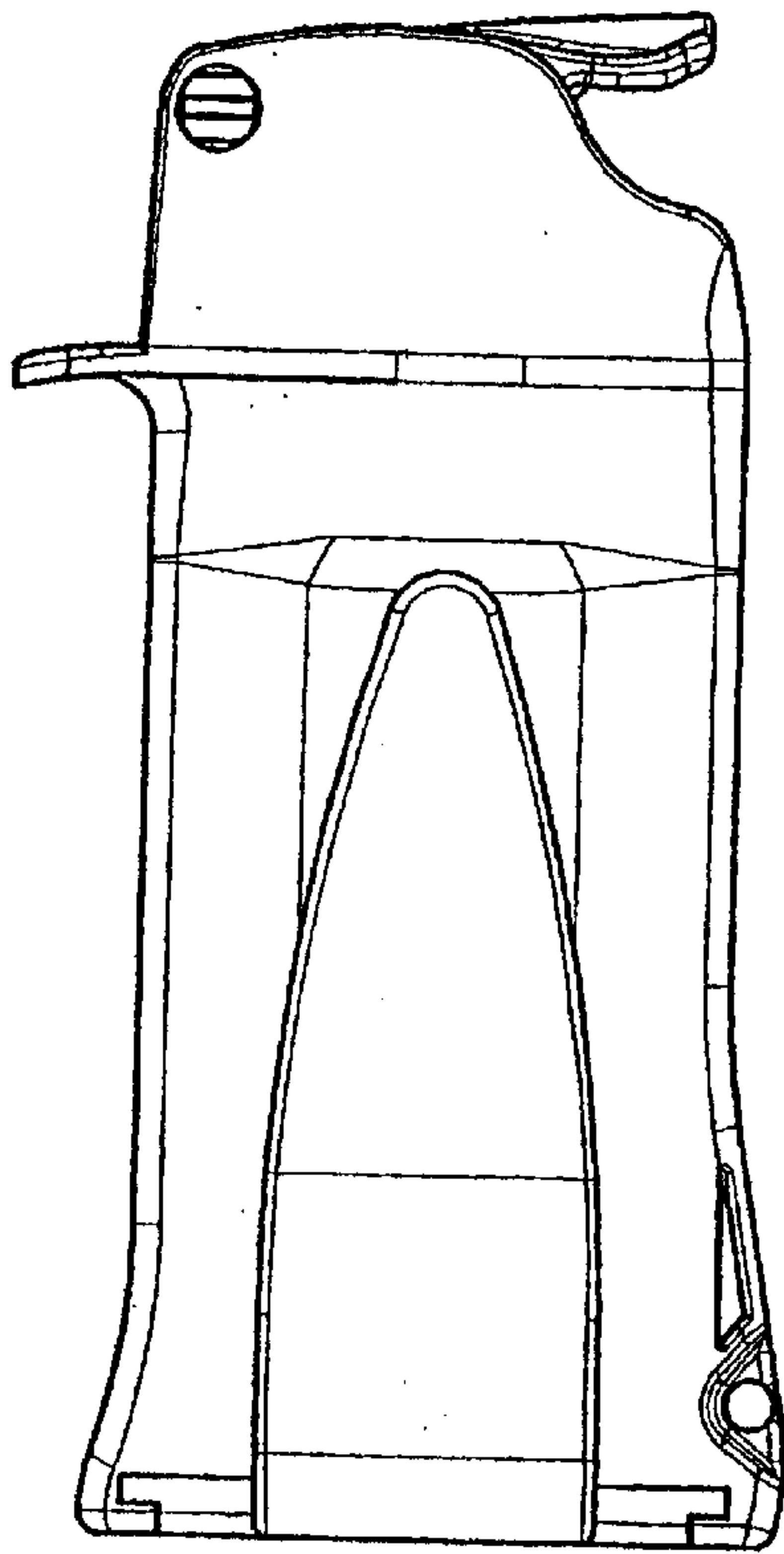

FIGURE 1

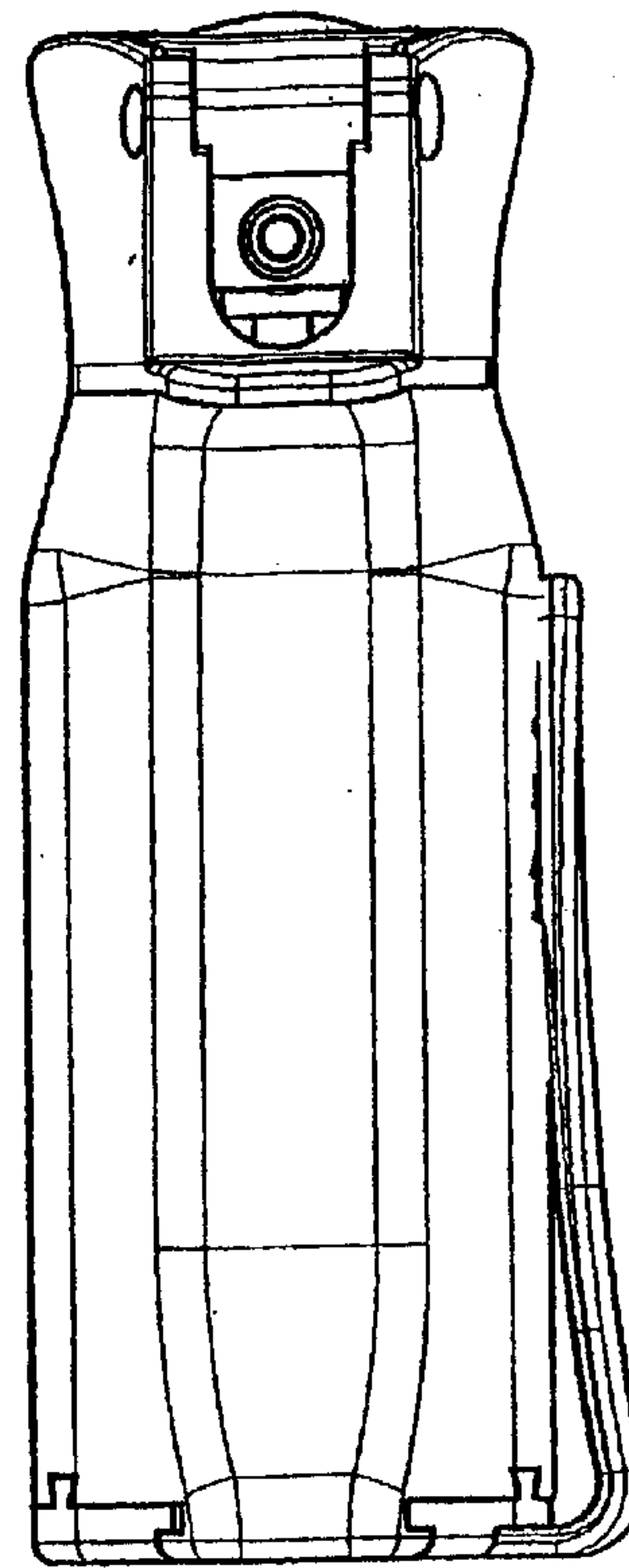

FIGURE 2

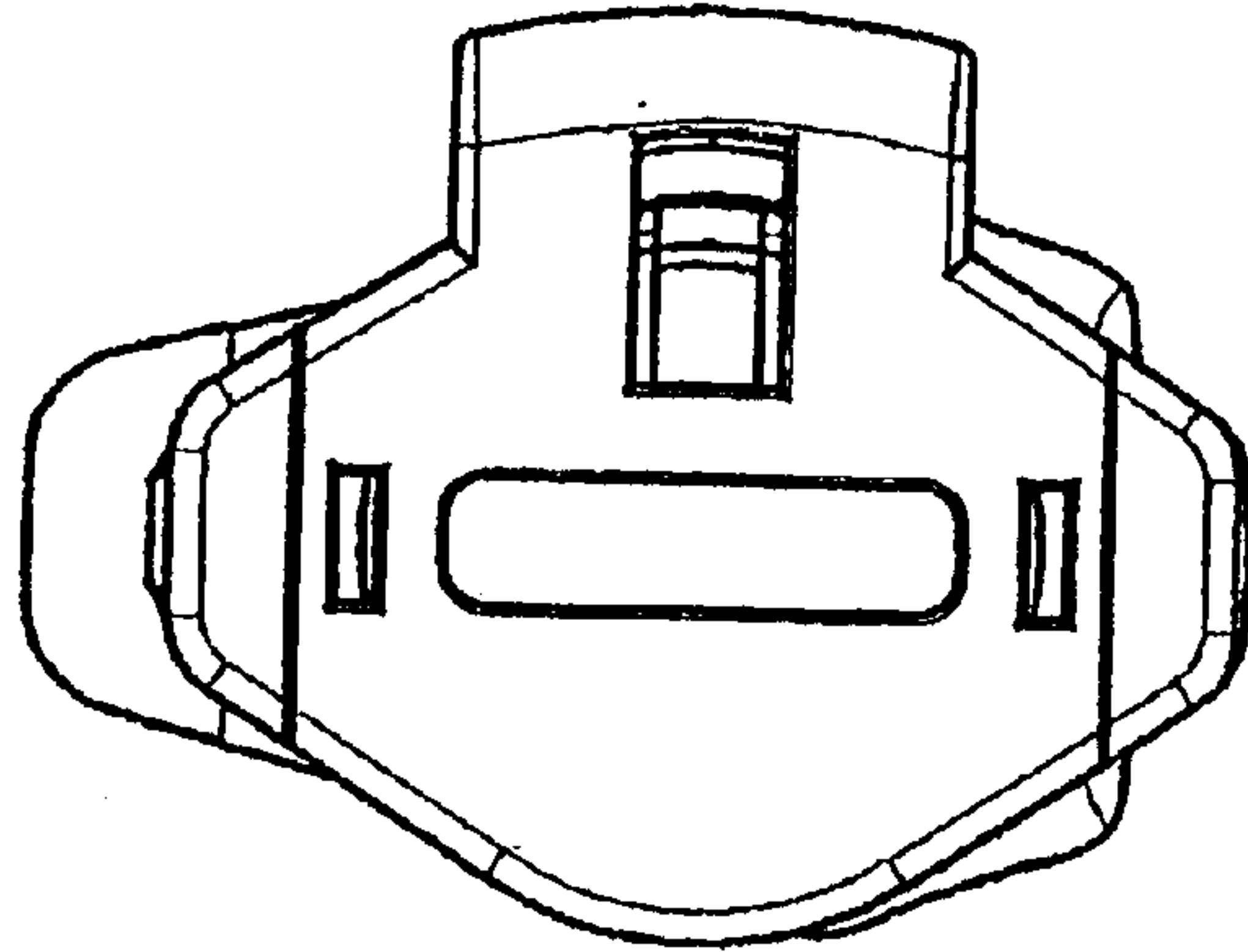

FIGURE 3

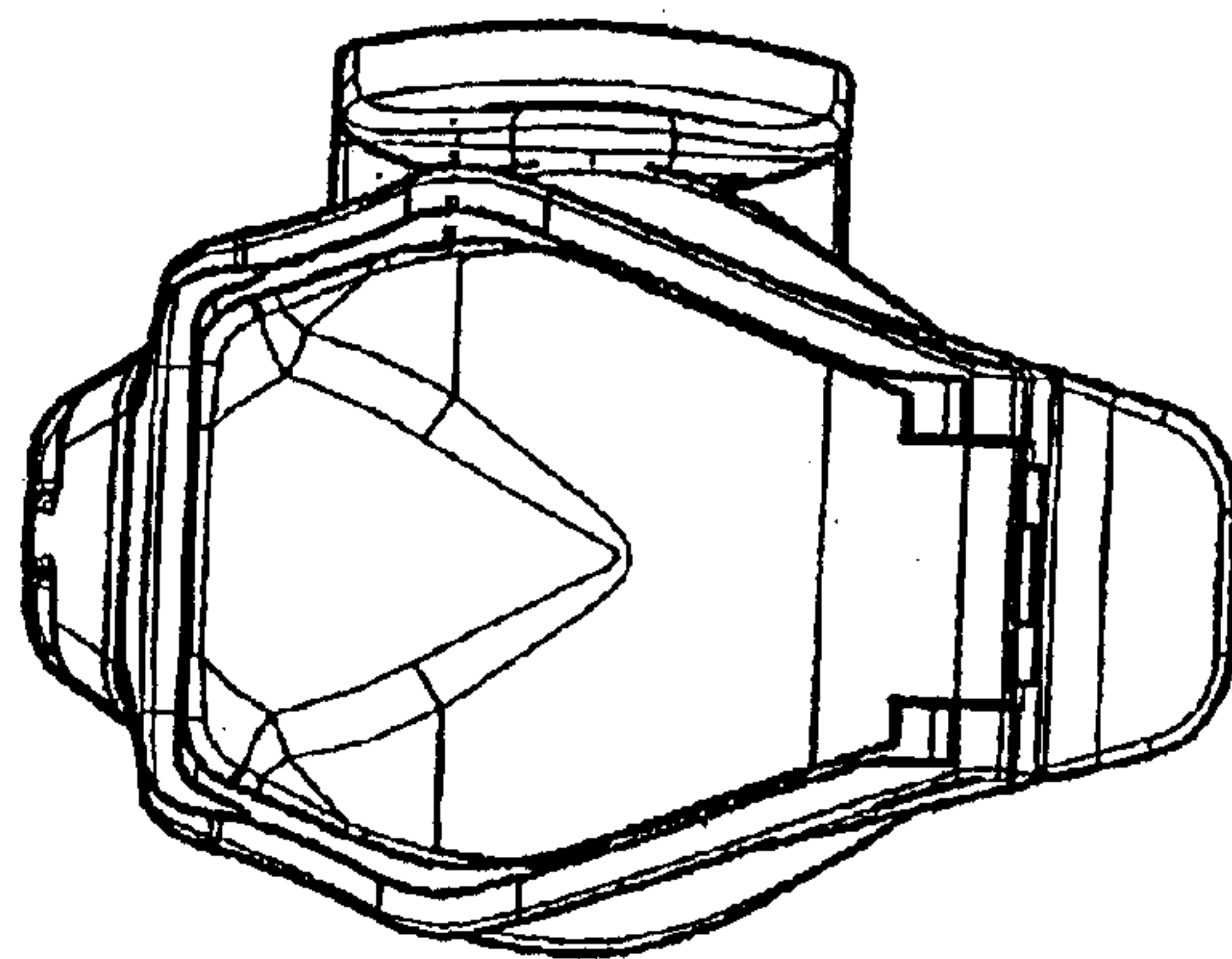

FIGURE 4

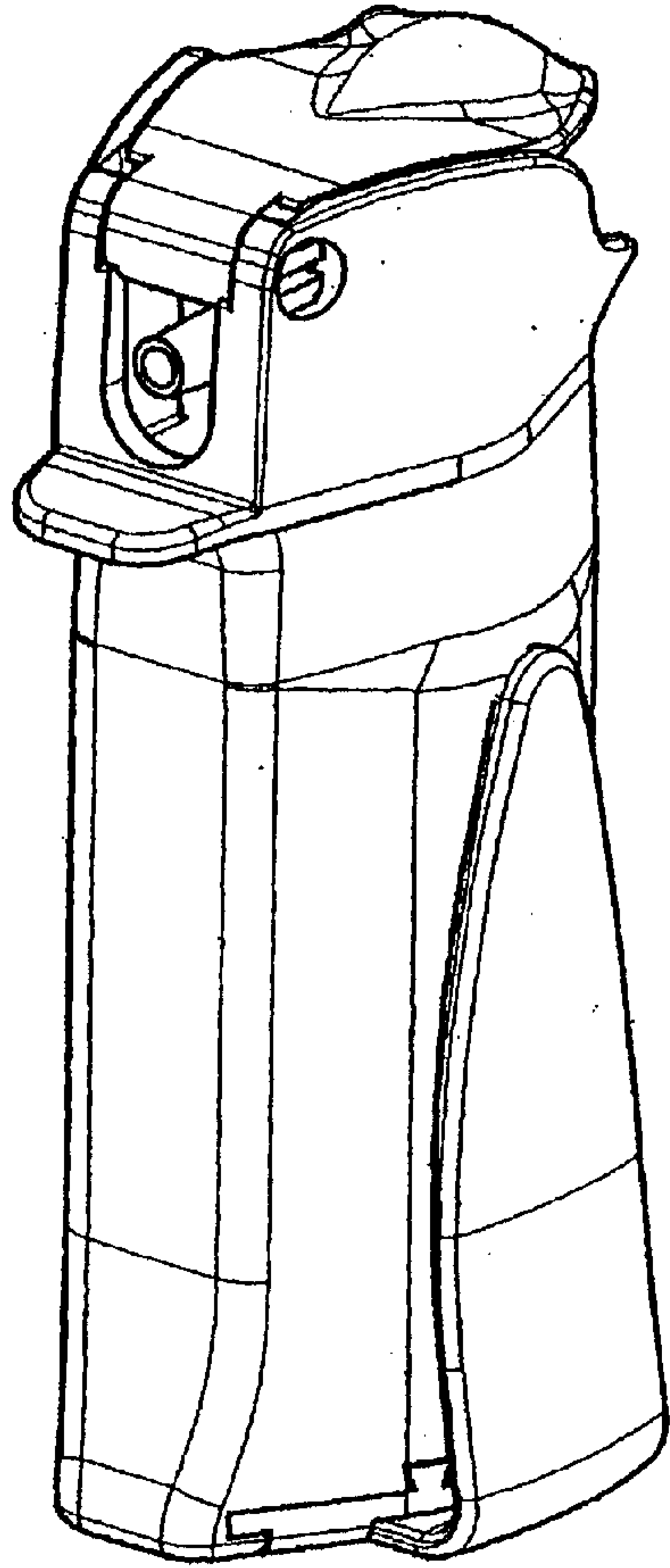

FIGURE 5

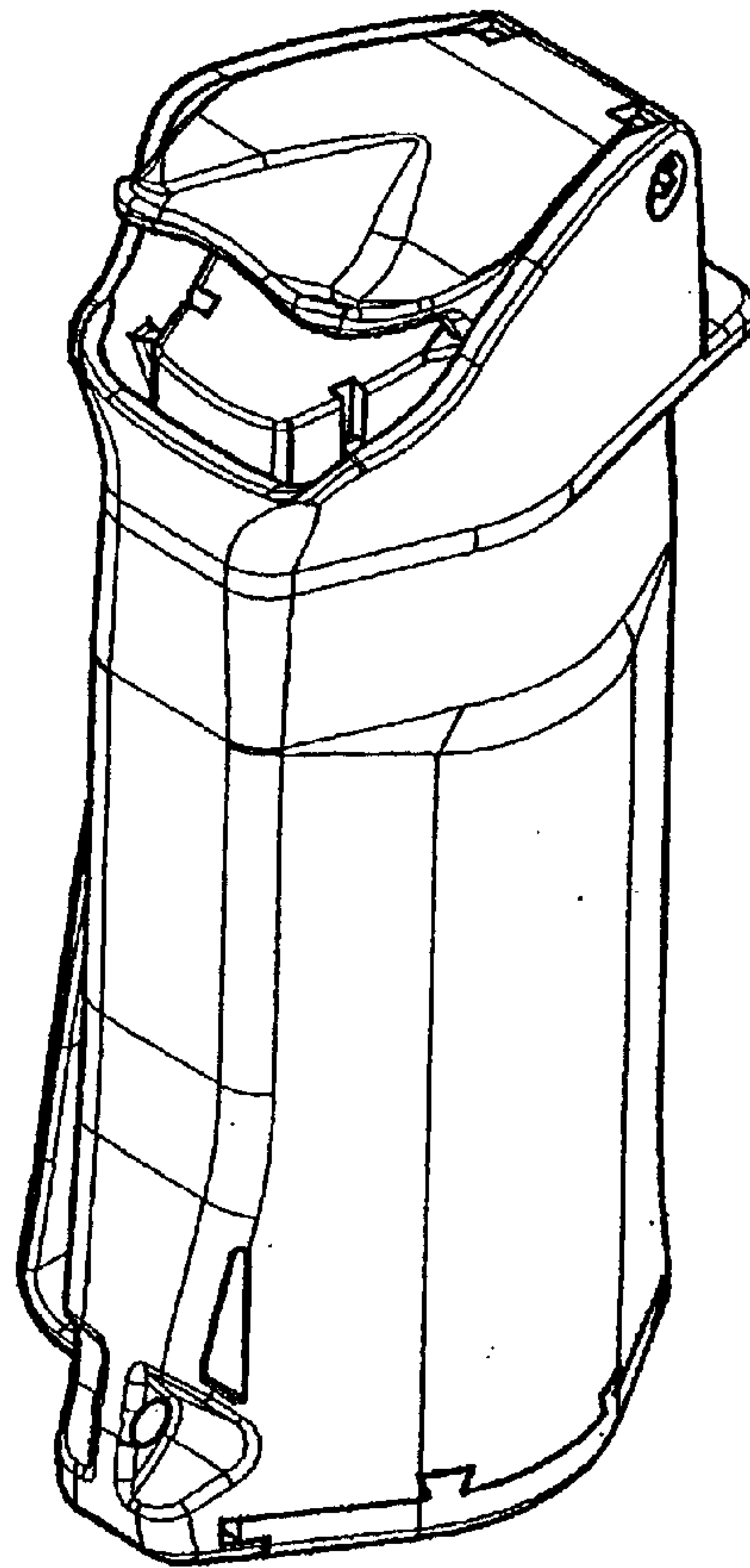

FIGURE 6

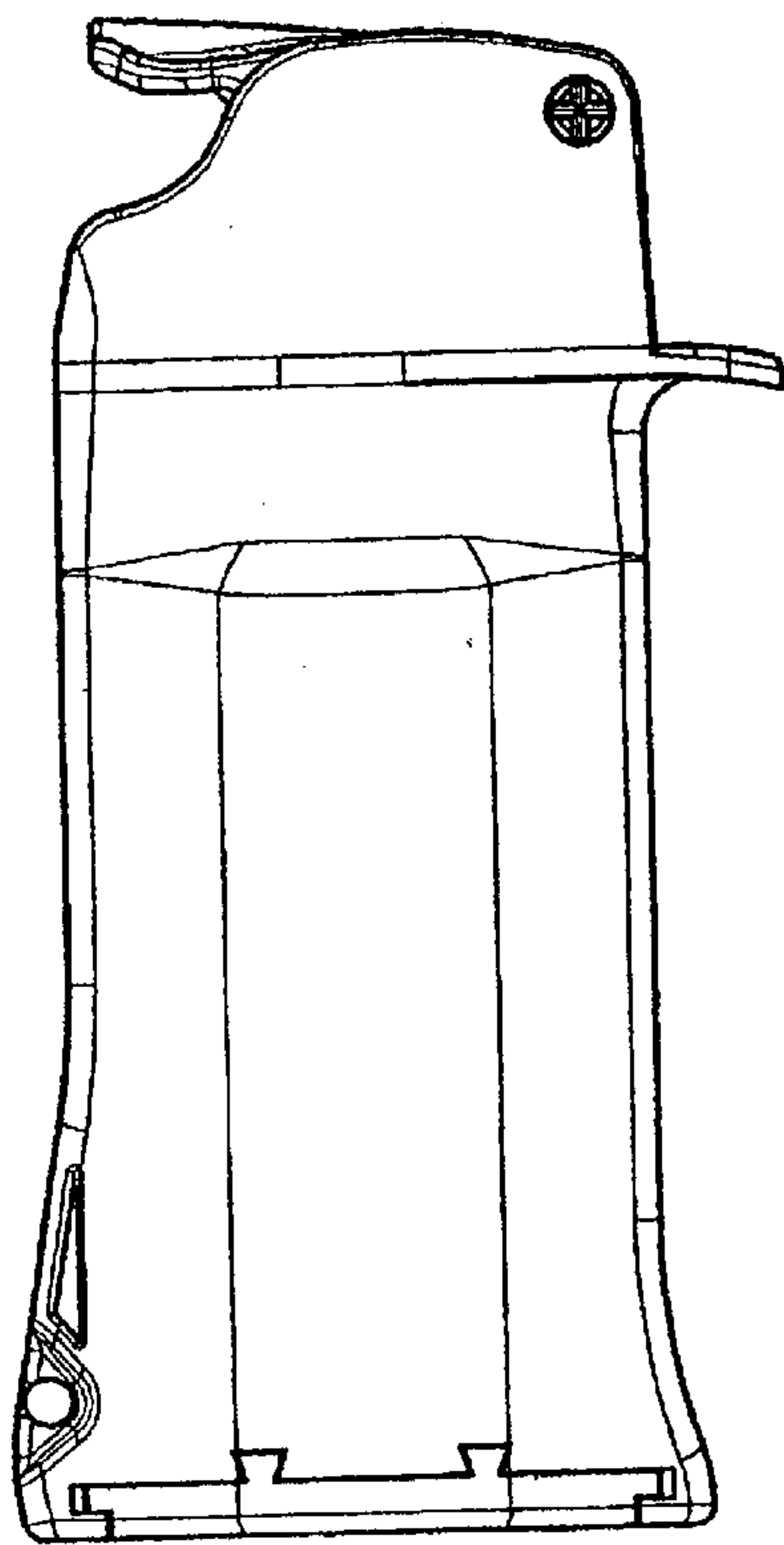

FIGURE 7

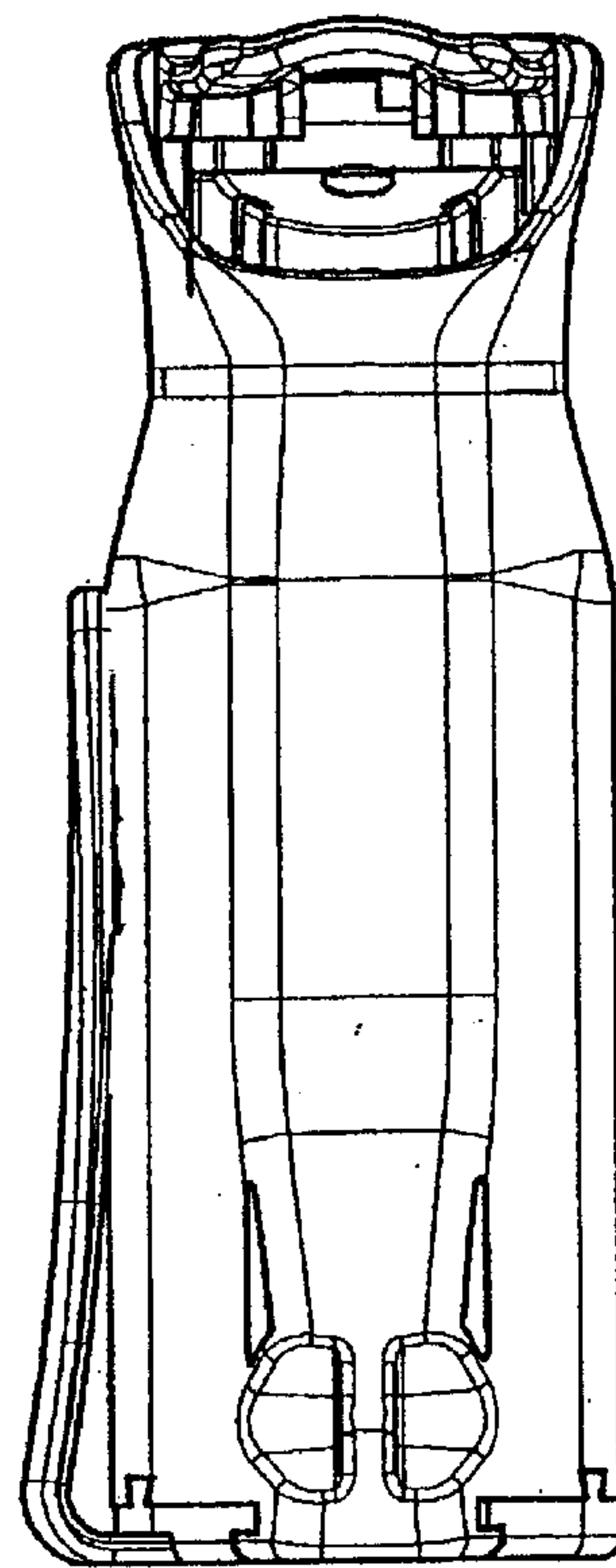

FIGURE 8

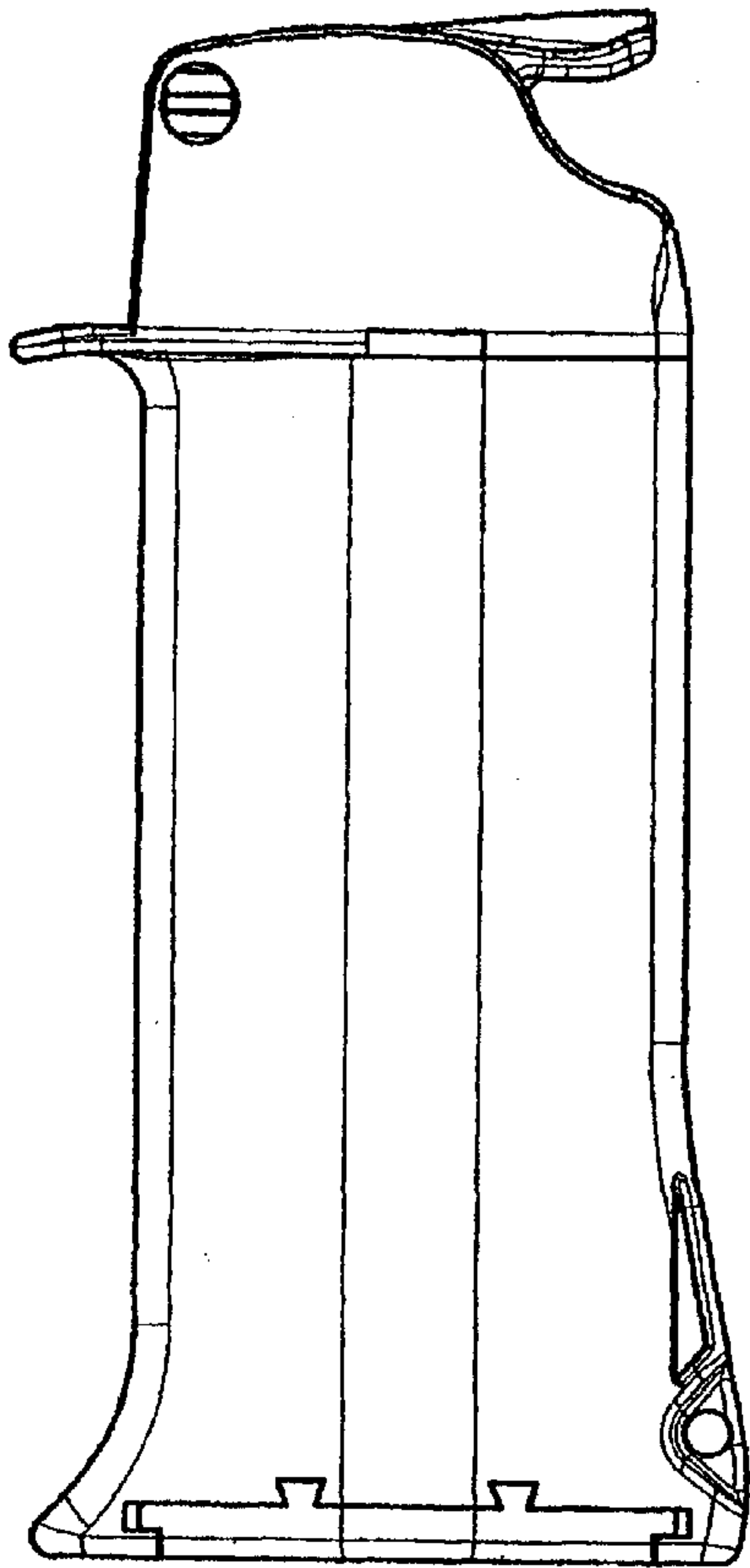

FIGURE 9

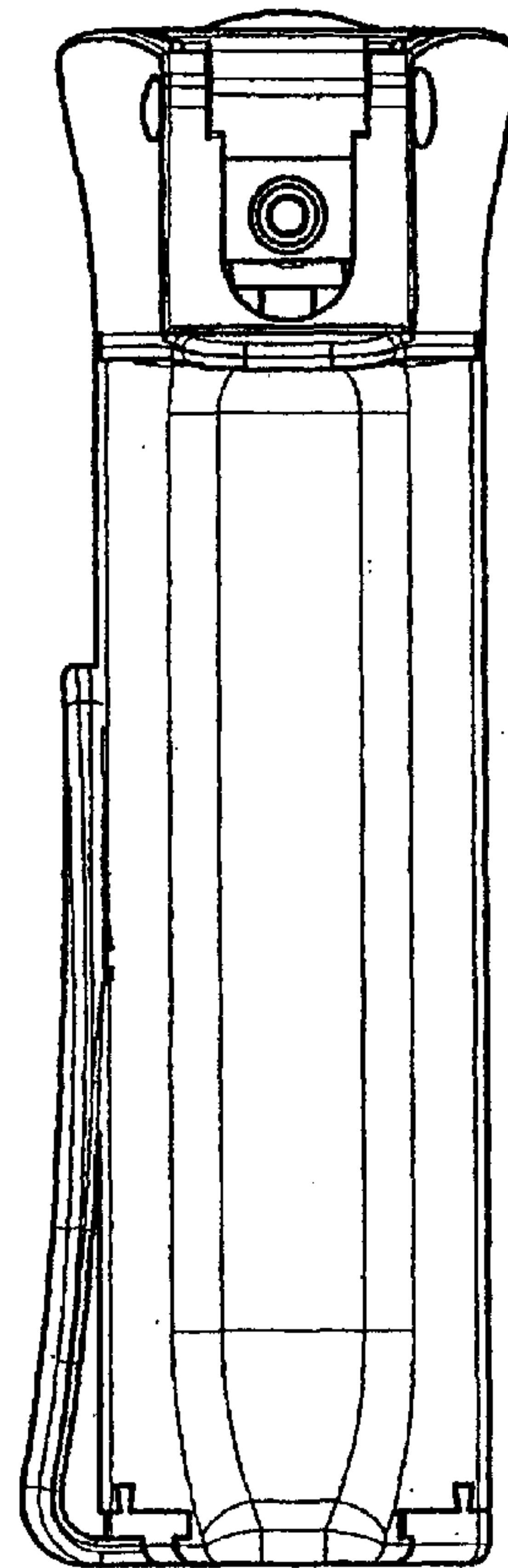

FIGURE 10

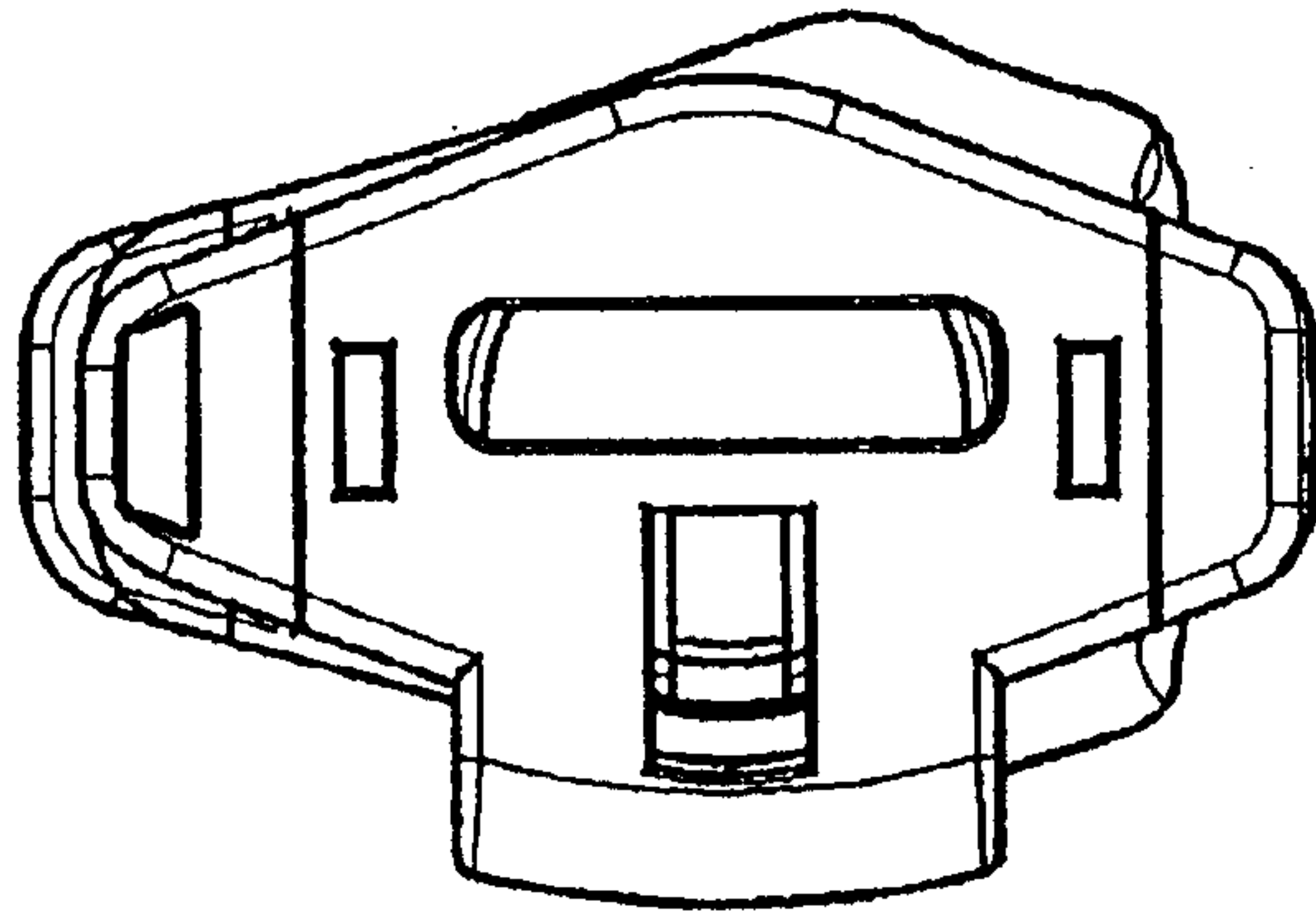

FIGURE 11

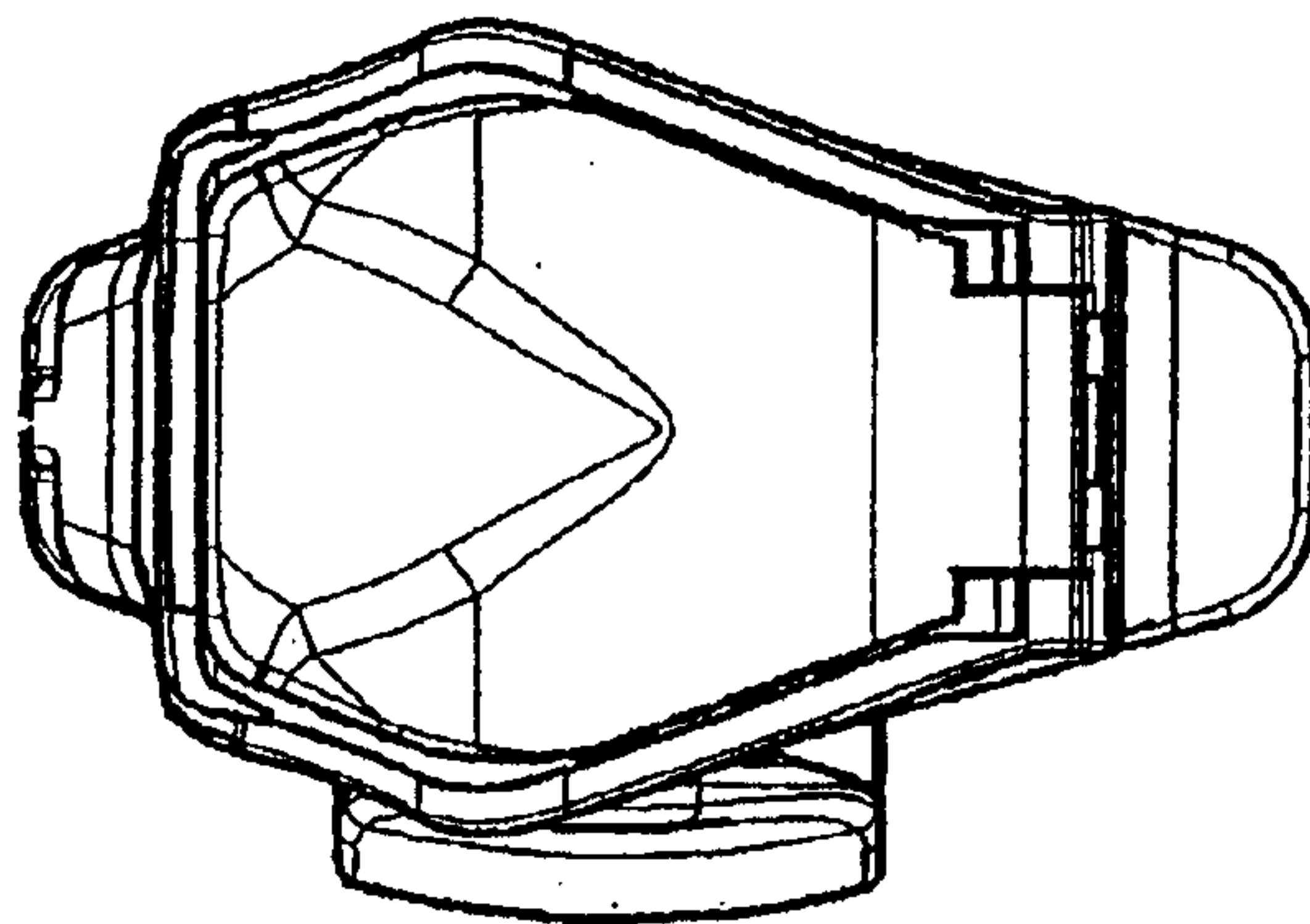

FIGURE 12

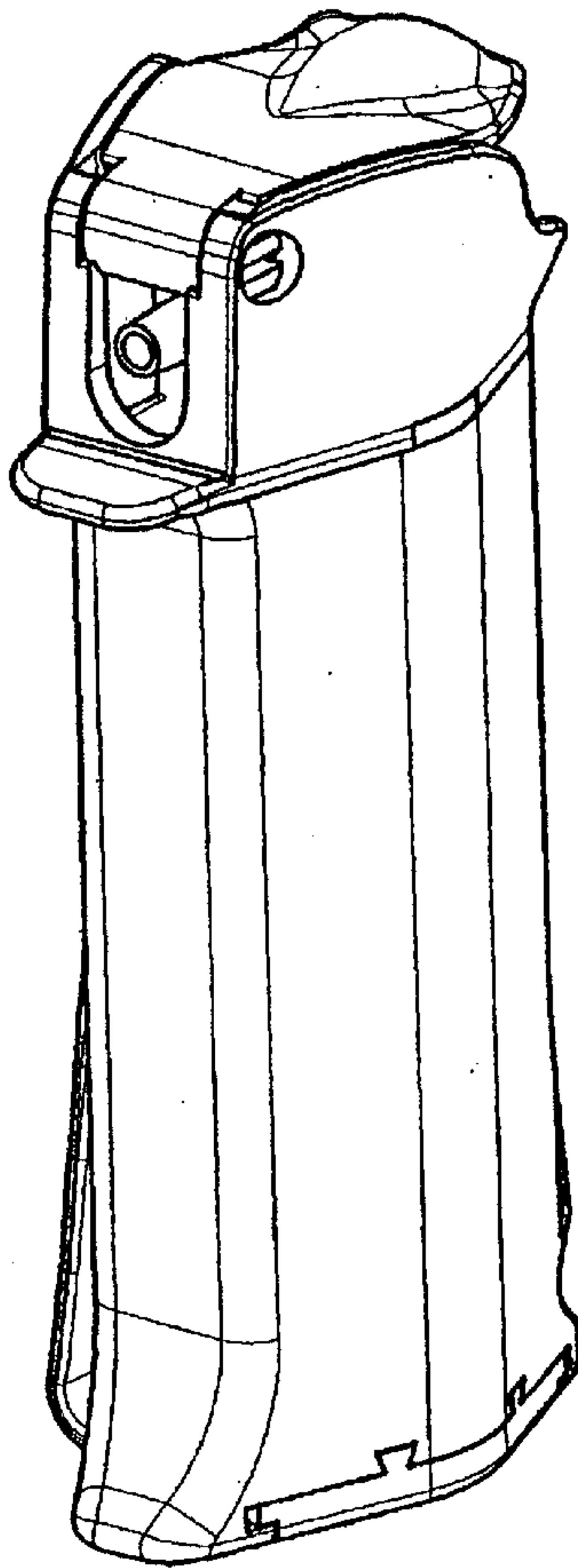

FIGURE 13

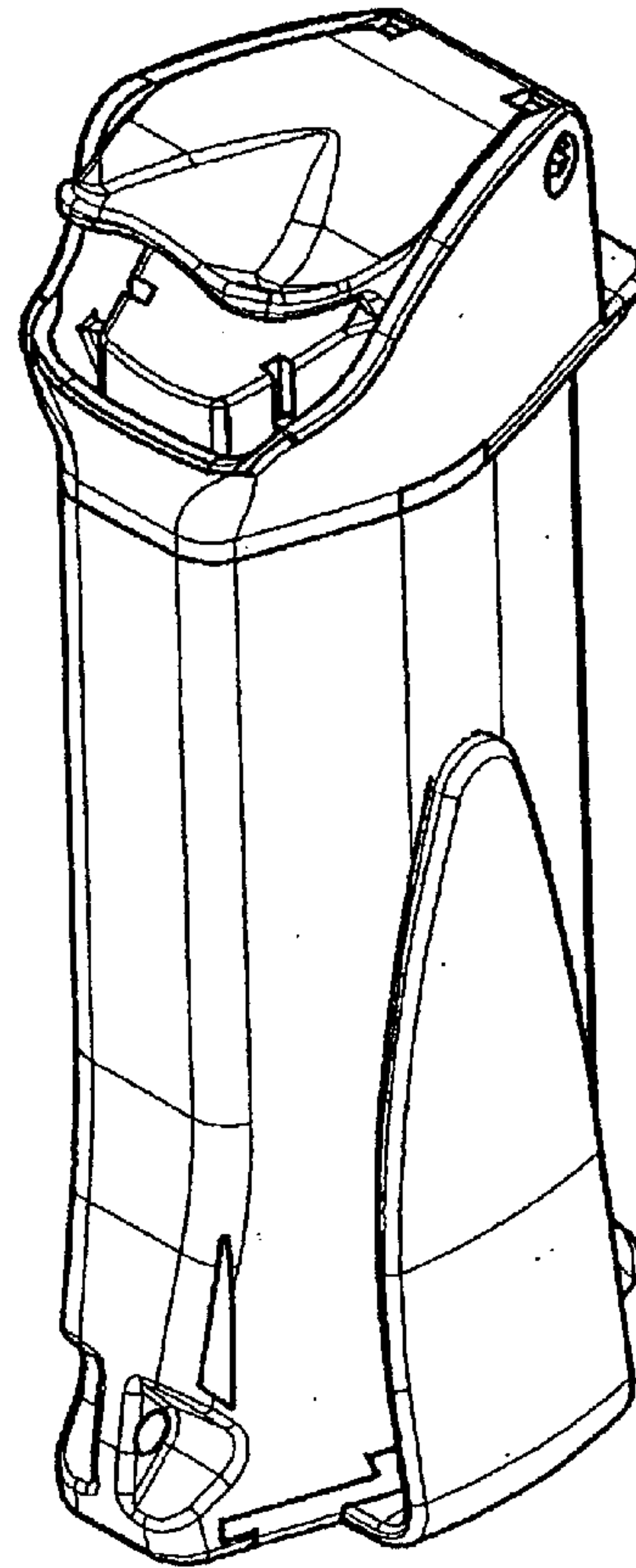

FIGURE 14

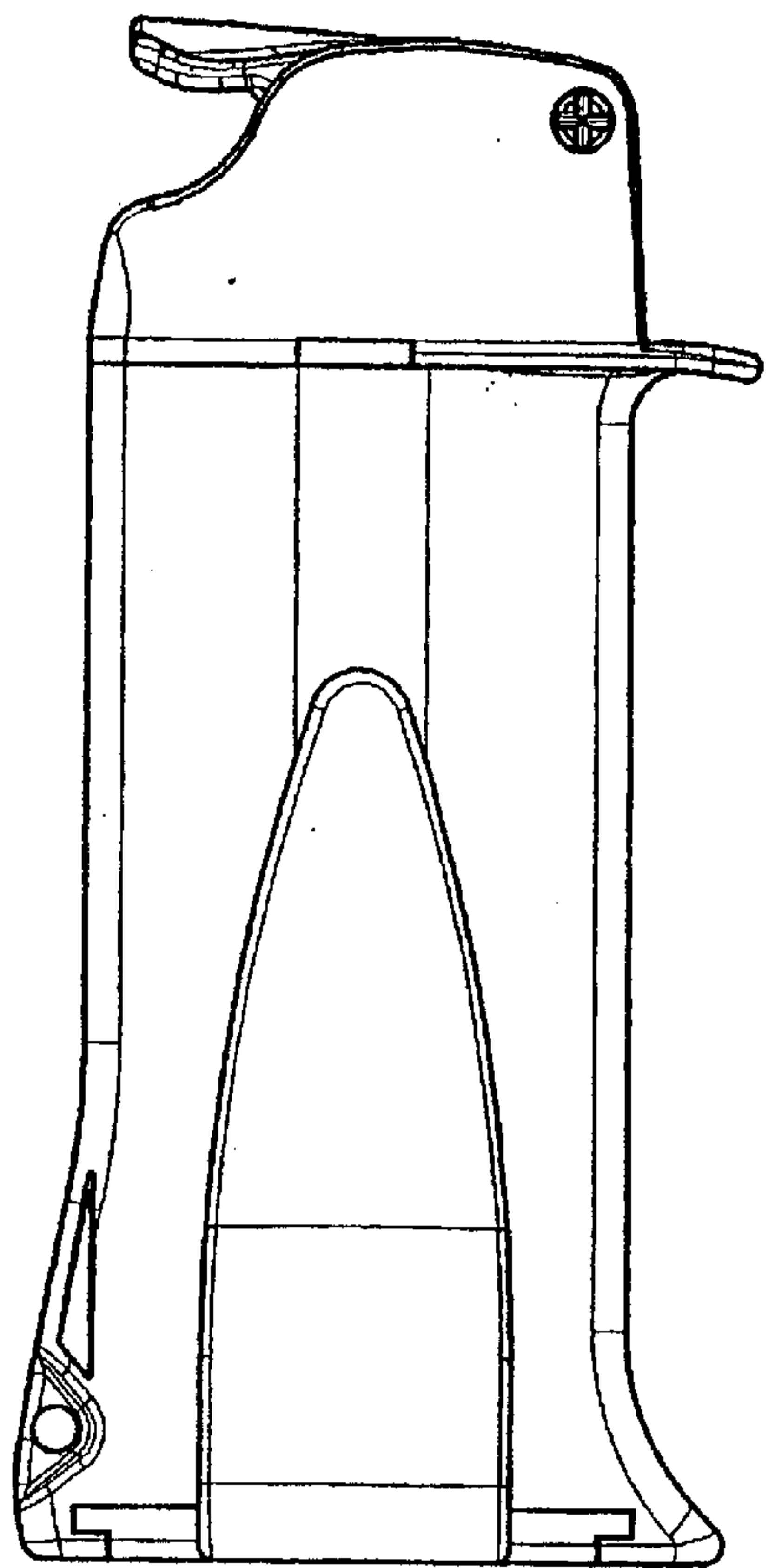

FIGURE 15

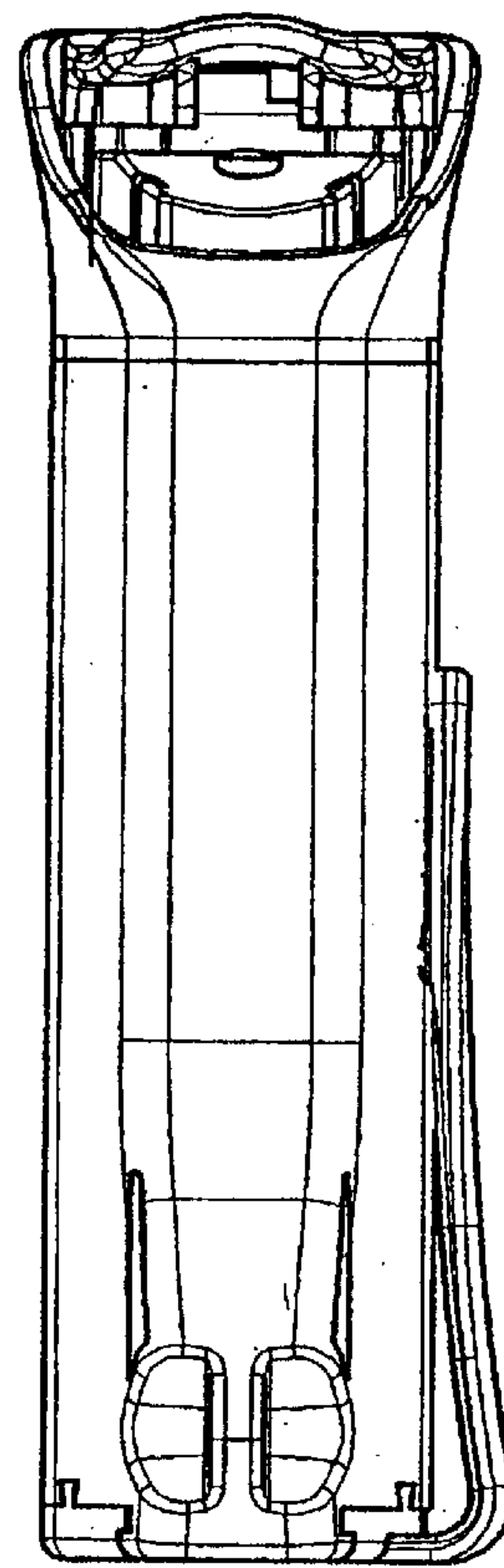

FIGURE 16