



US00D552981S

(12) **United States Design Patent**
Yamaguchi

(10) **Patent No.:** **US D552,981 S**

(45) **Date of Patent:** **** Oct. 16, 2007**

(54) **STAY FOR FURNITURE**

- (75) Inventor: **Koushi Yamaguchi**, Tokyo (JP)
- (73) Assignee: **Sugalsune Kogyo Co. Ltd**, Tokyo (JP)
- (**) Term: **14 Years**
- (21) Appl. No.: **29/265,462**
- (22) Filed: **Sep. 1, 2006**

(30) **Foreign Application Priority Data**

Mar. 3, 2006 (JP) 2006-005415

- (51) **LOC (8) Cl.** **08-09**
- (52) **U.S. Cl.** **D8/402**
- (58) **Field of Classification Search** D8/400,
D8/402, 499; 16/82, 277, 286, 339, 345,
16/404, DIG. 10
See application file for complete search history.

(56) **References Cited**

U.S. PATENT DOCUMENTS

D152,936 S *	3/1949	Bloom	D8/400
D249,225 S *	9/1978	Moe	D8/330
4,134,608 A *	1/1979	Pool	292/76
D257,664 S *	12/1980	McKee	D8/354
D293,037 S *	12/1987	Capawana	D34/35
D317,713 S *	6/1991	Kaplan	D8/402
5,079,797 A *	1/1992	Ohshima et al.	16/82
D343,114 S *	1/1994	Deegan	D8/402
D356,274 S *	3/1995	Ross et al.	D10/104
5,647,578 A *	7/1997	Bivens	267/34
D411,979 S *	7/1999	Getz	D12/223
D437,772 S *	2/2001	Erwin	D8/354
D451,367 S *	12/2001	Nakamura	D8/330
D459,983 S *	7/2002	Hayakawa	D8/402
D491,454 S *	6/2004	Yamaguchi	D8/402
D523,325 S *	6/2006	Ignagni	D8/354

FOREIGN PATENT DOCUMENTS

JP 9328946 12/1997

OTHER PUBLICATIONS

Website: Isaac Lord Limited: product name: "Lift Up Flap Stay 450"; <http://www.isaaclord.co.uk>.*

* cited by examiner

Primary Examiner—Alan P. Douglas

Assistant Examiner—Barbara Fox

(74) *Attorney, Agent, or Firm*—Bacon & Thomas, PLLC

(57) **CLAIM**

The ornamental design for stay for furniture, as shown and described.

DESCRIPTION

FIG. 1 is a front view of stay for furniture embodying my new design;

FIG. 2 is a top plan view thereof;

FIG. 3 is a bottom view thereof;

FIG. 4 is a rear view thereof;

FIG. 5 is a left side view thereof;

FIG. 6 is a right side view thereof;

FIG. 7 is a sectional view along 7—7 plane thereof;

FIG. 8 is an enlarged view of 8—8 portion thereof;

FIG. 9 is an enlarged view of 9—9 portion thereof;

FIG. 10 is an enlarged view of 10—10 portion thereof;

FIG. 11 is a sectional view along 11—11 plane thereof;

FIG. 12 is an enlarged left side view thereof;

FIG. 13 is an enlarged right side view thereof;

FIG. 14 is a referential front view in contraction state; and,

FIG. 15 is a perspective view thereof.

The broken line showing of the stay for furniture is included for the purposes of illustrating the environmental structure and forms no part of the claimed design.

1 Claim, 5 Drawing Sheets

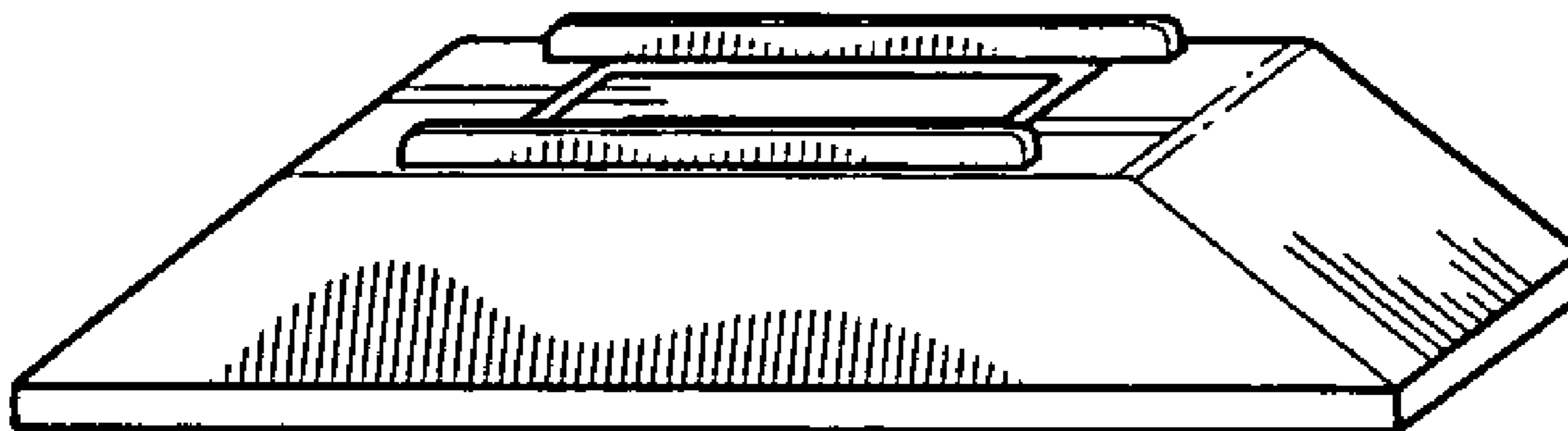

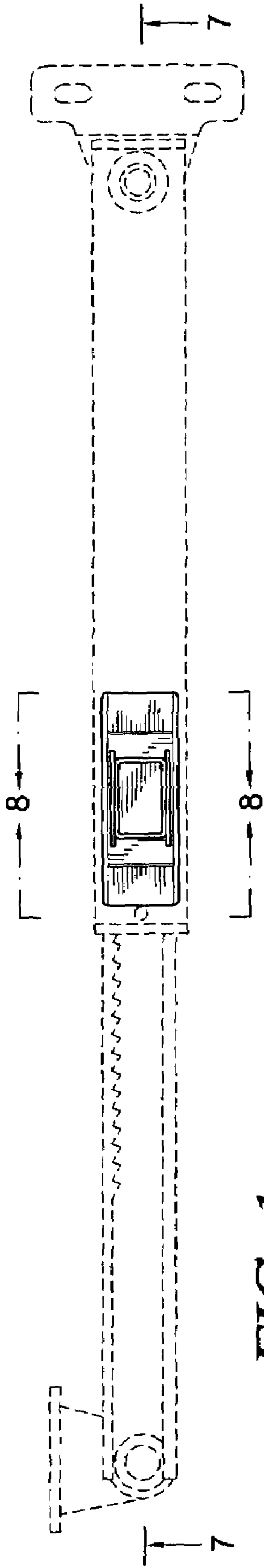

FIG. 1

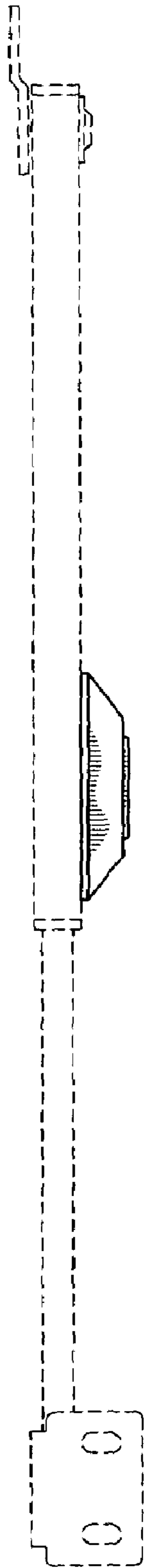

FIG. 2

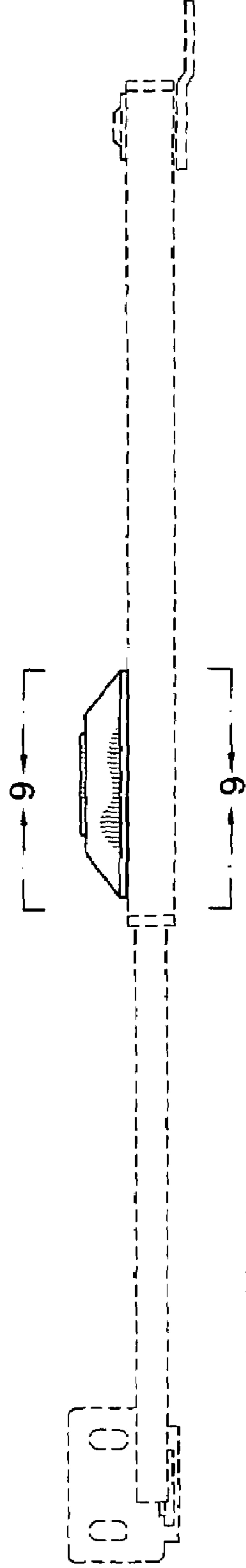

FIG. 3

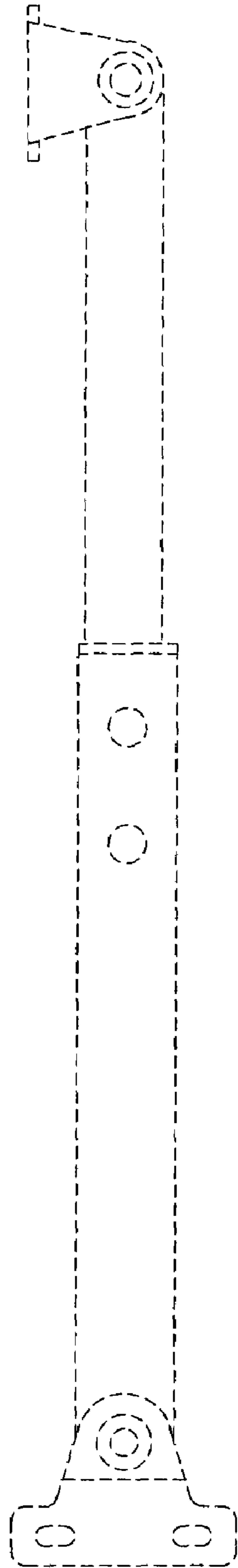

FIG. 4

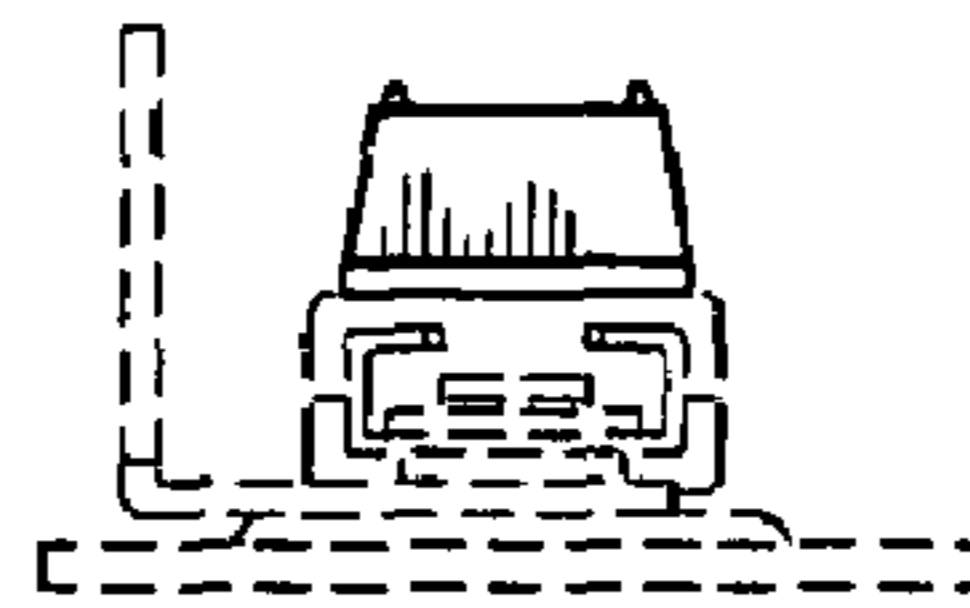

FIG. 5



FIG. 6

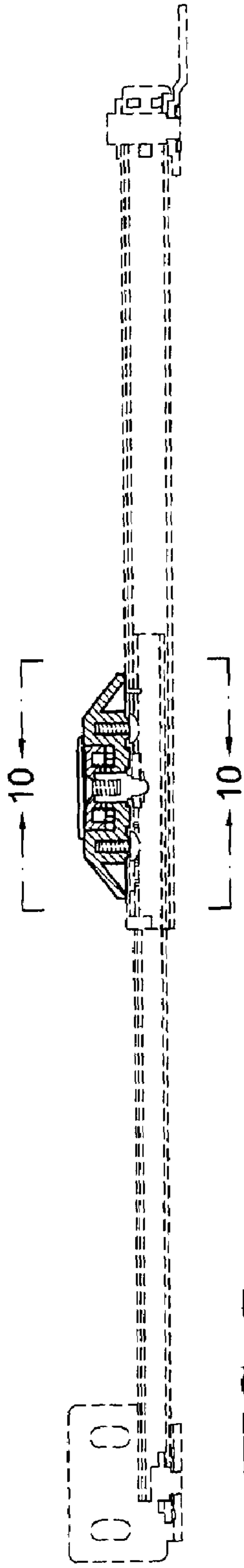

FIG. 7

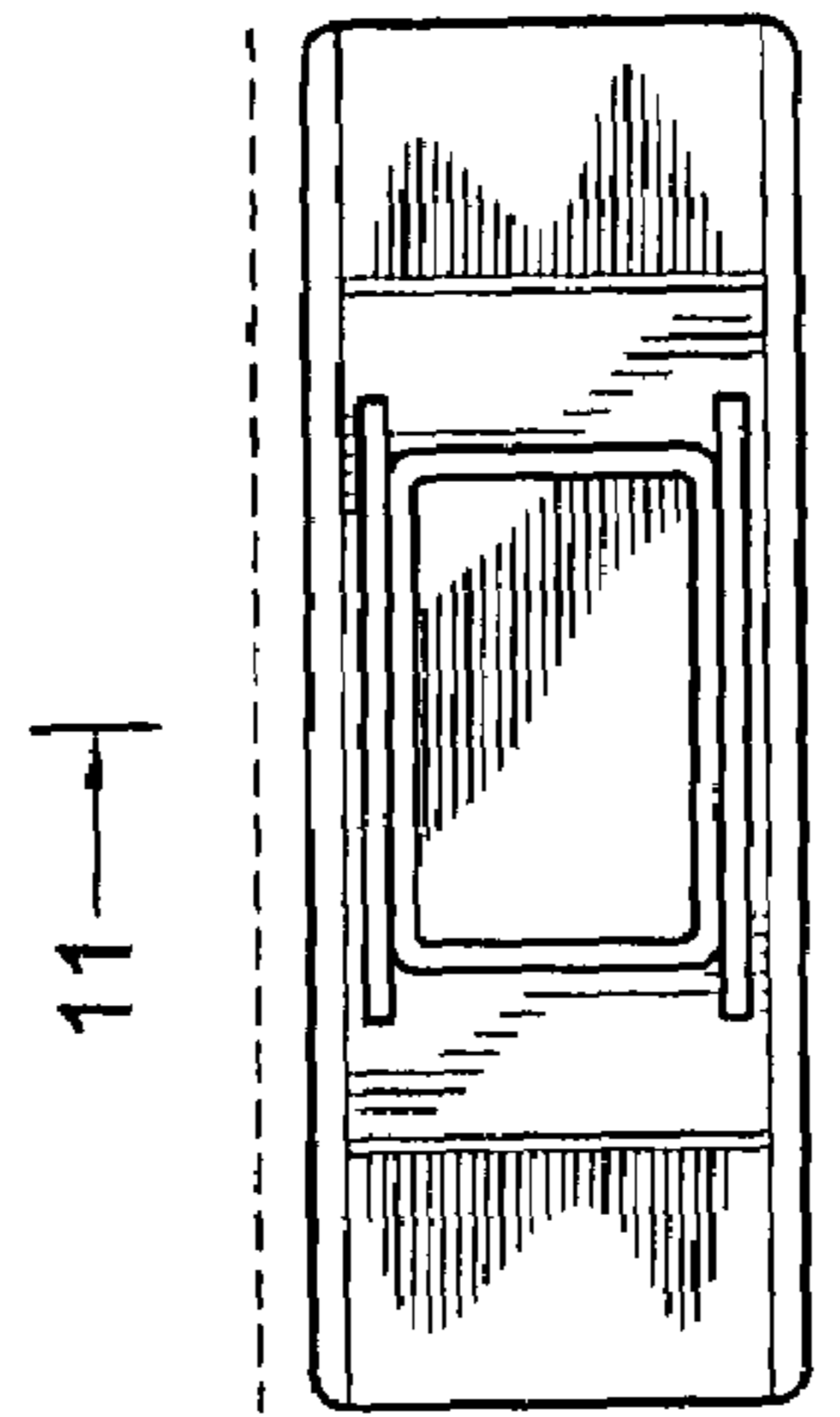

FIG. 8

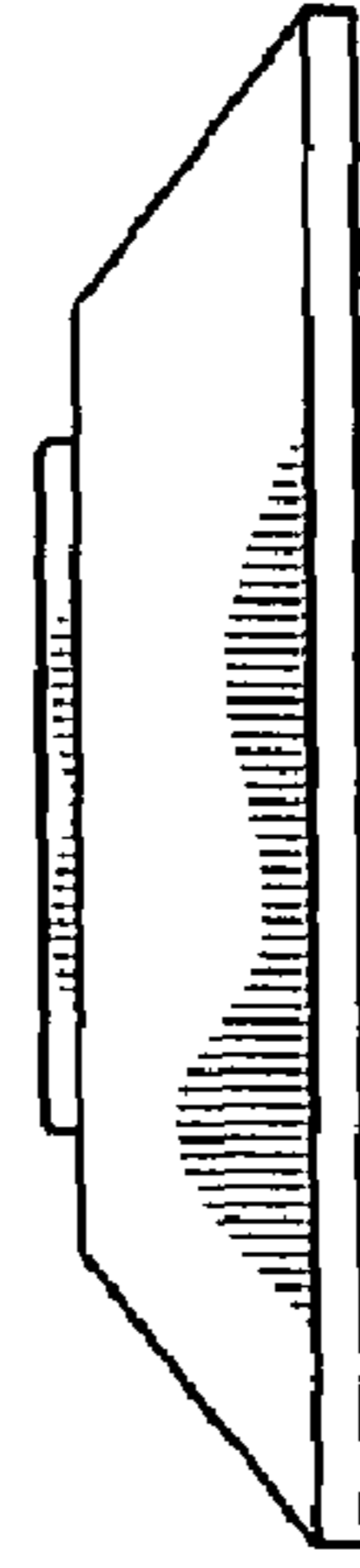

FIG. 9

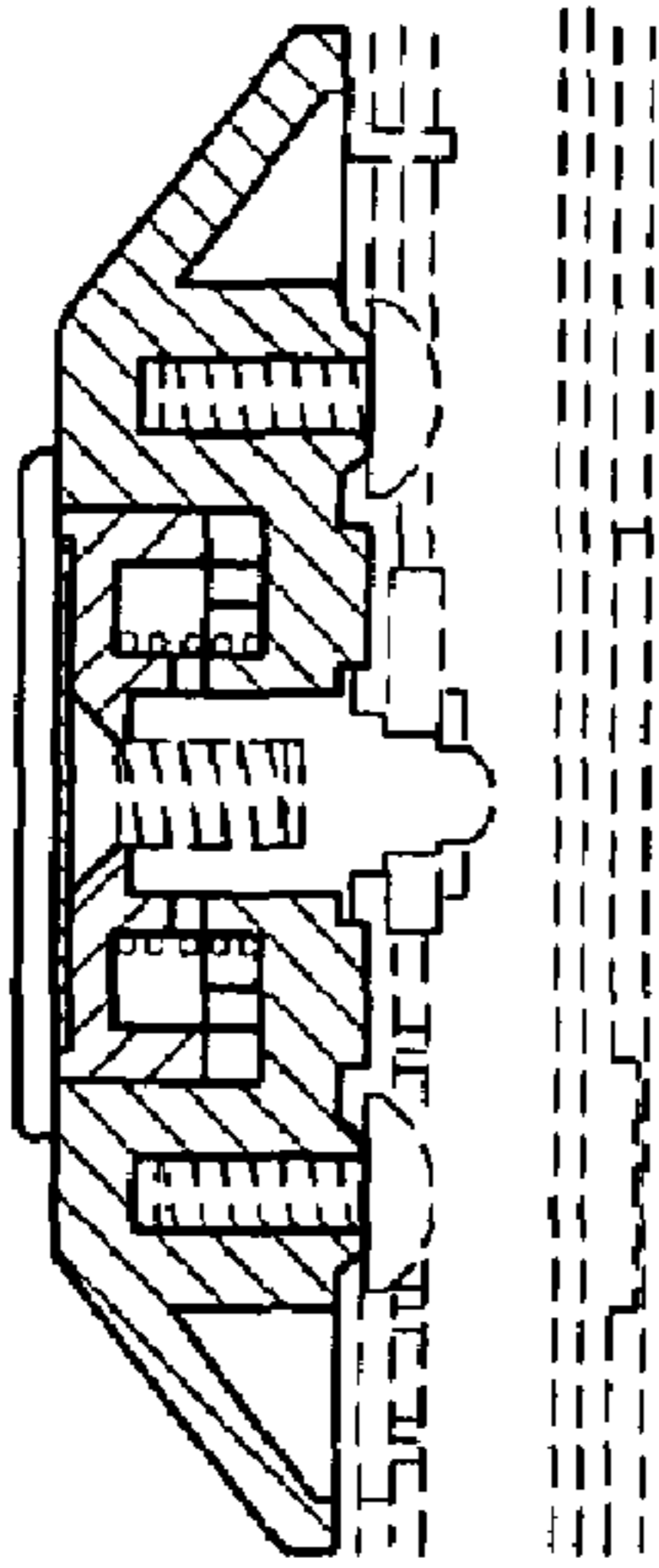

FIG. 10

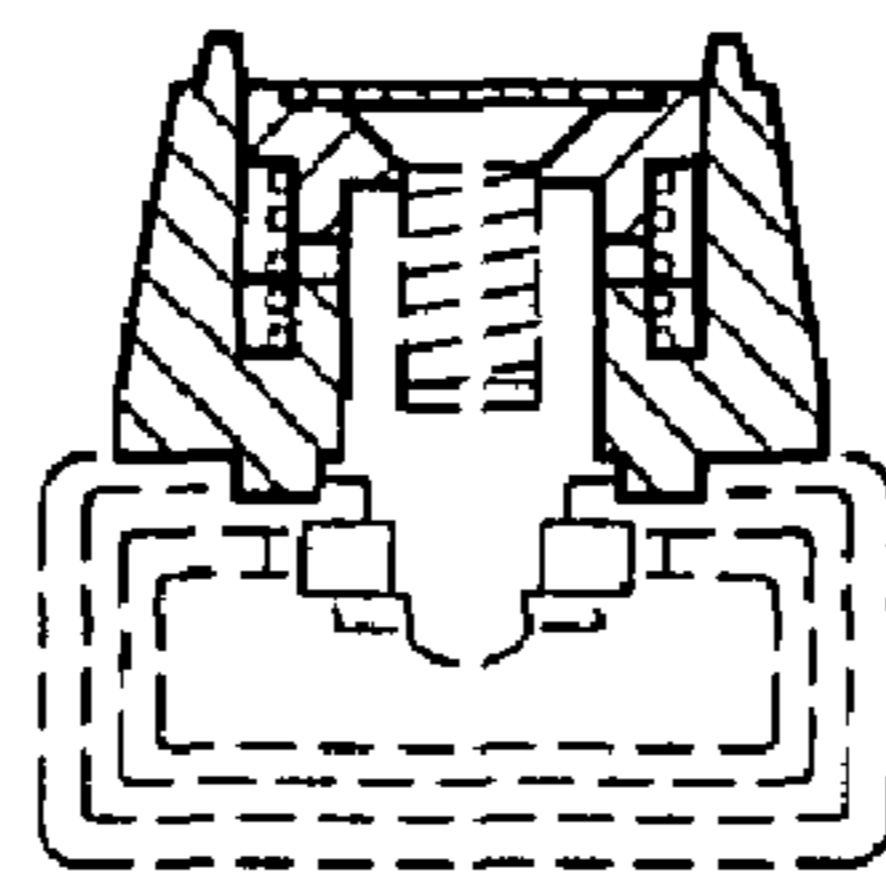

FIG. 11

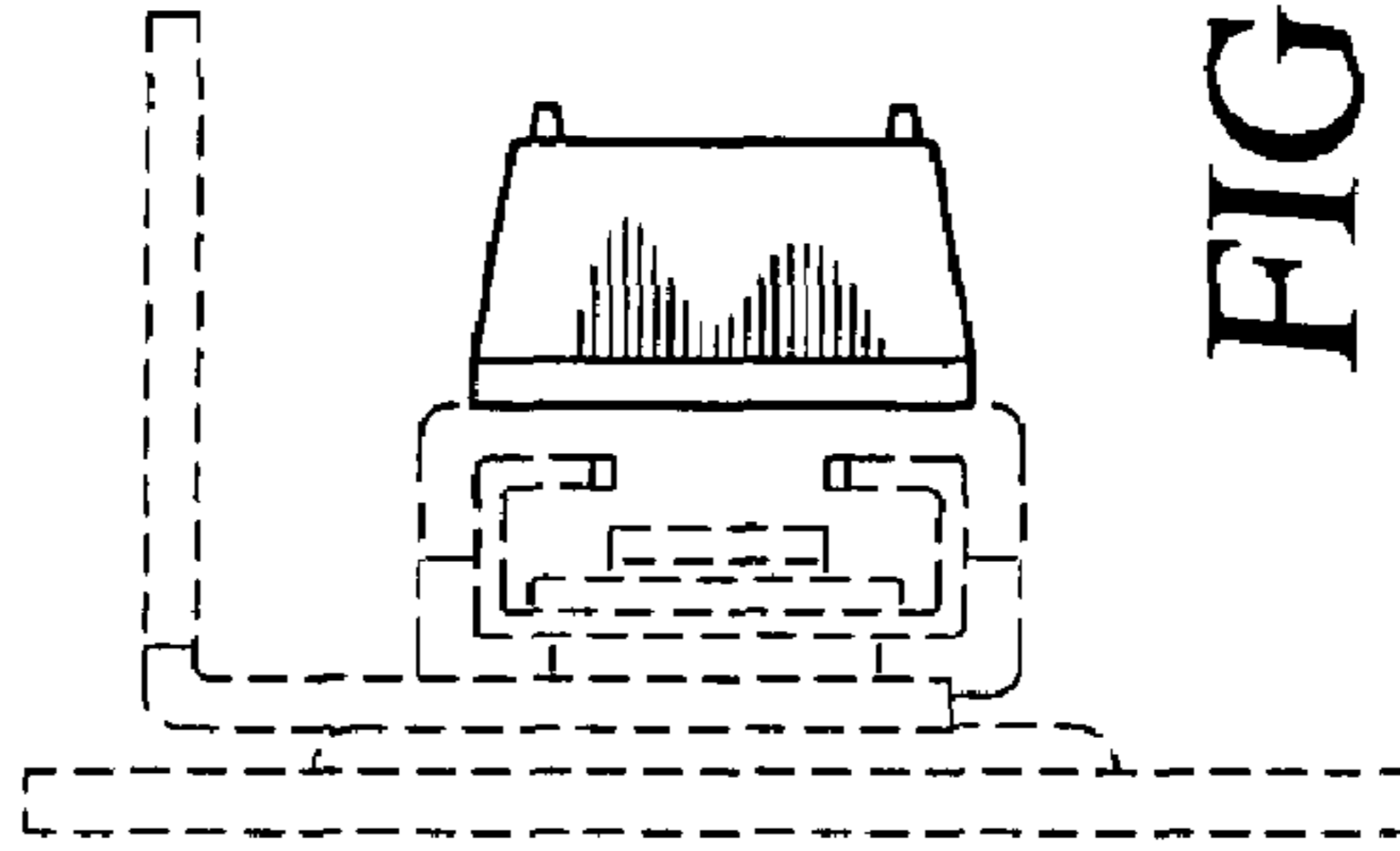

FIG. 12

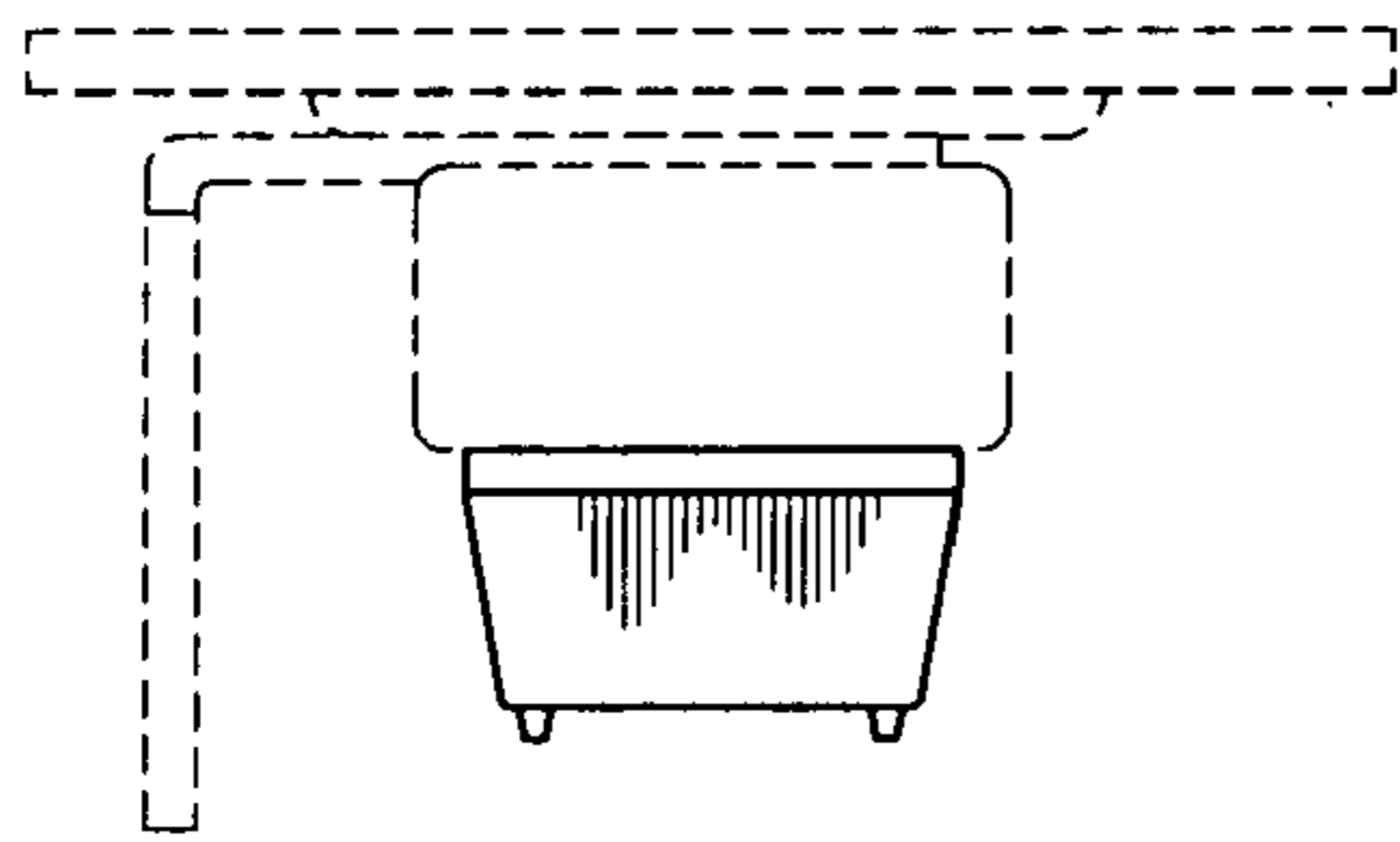

FIG. 13

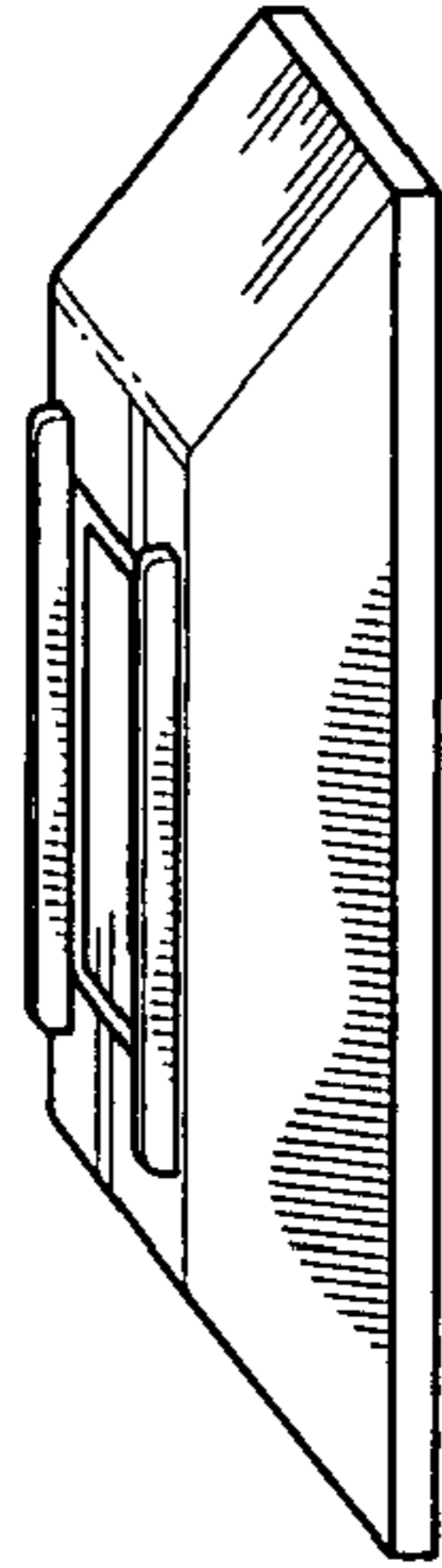

FIG. 15

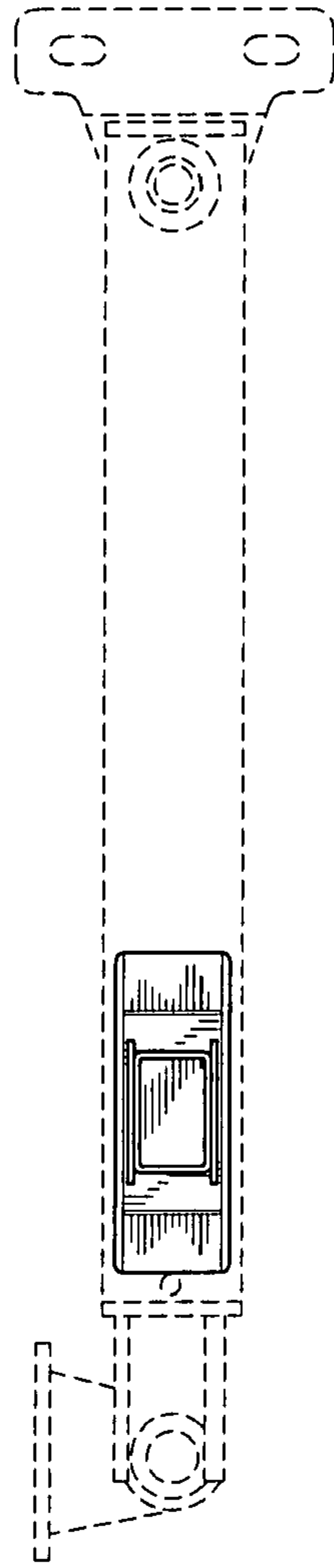

FIG. 14