

US00D552859S

(12) **United States Design Patent**
Hock

(10) **Patent No.:** **US D552,859 S**

(45) **Date of Patent:** **** Oct. 16, 2007**

(54) **CHAIR**

(76) Inventor: **Koh Tuang Hock**, 235 Chung-Ho Box
8-24, Taipei (TW)

(**) Term: **14 Years**

(21) Appl. No.: **29/272,244**

(22) Filed: **Feb. 5, 2007**

(51) **LOC (8) Cl.** **06-01**

(52) **U.S. Cl.** **D6/374; D6/380**

(58) **Field of Classification Search** D6/334-336,
D6/371-373, 374, 375, 376, 379, 380, 500-502;
297/183.7, 239, 446.1, 446.2, 452.46
See application file for complete search history.

(56) **References Cited**

U.S. PATENT DOCUMENTS

D308,143 S *	5/1990	Lohmeyer	D6/379
D361,675 S *	8/1995	Ruy	D6/379
D395,177 S *	6/1998	Dammerman et al.	D6/380
D411,772 S *	7/1999	Piretti	D6/374
D433,836 S *	11/2000	Barile, Sr.	D6/380
D449,938 S *	11/2001	Vanderiet et al.	D6/380

D455,571 S *	4/2002	Van De Riet et al.	D6/374
D456,164 S *	4/2002	Vanderiet et al.	D6/374
D485,084 S *	1/2004	Bales	D6/379
6,899,396 B2 *	5/2005	Bales	297/446.2
D513,134 S *	12/2005	Asano et al.	D6/380

* cited by examiner

Primary Examiner—Mimosa De

(57) **CLAIM**

The ornamental design for a chair, as shown and described.

DESCRIPTION

FIG. 1 is a perspective view of a chair showing my new design.

FIG. 2 is a front elevational view thereof.

FIG. 3 is a rear elevational view thereof.

FIG. 4 is a left side view thereof;

FIG. 5 is a right side view thereof.

FIG. 6 is a top plan view thereof; and,

FIG. 7 is a bottom plan view thereof.

1 Claim, 7 Drawing Sheets

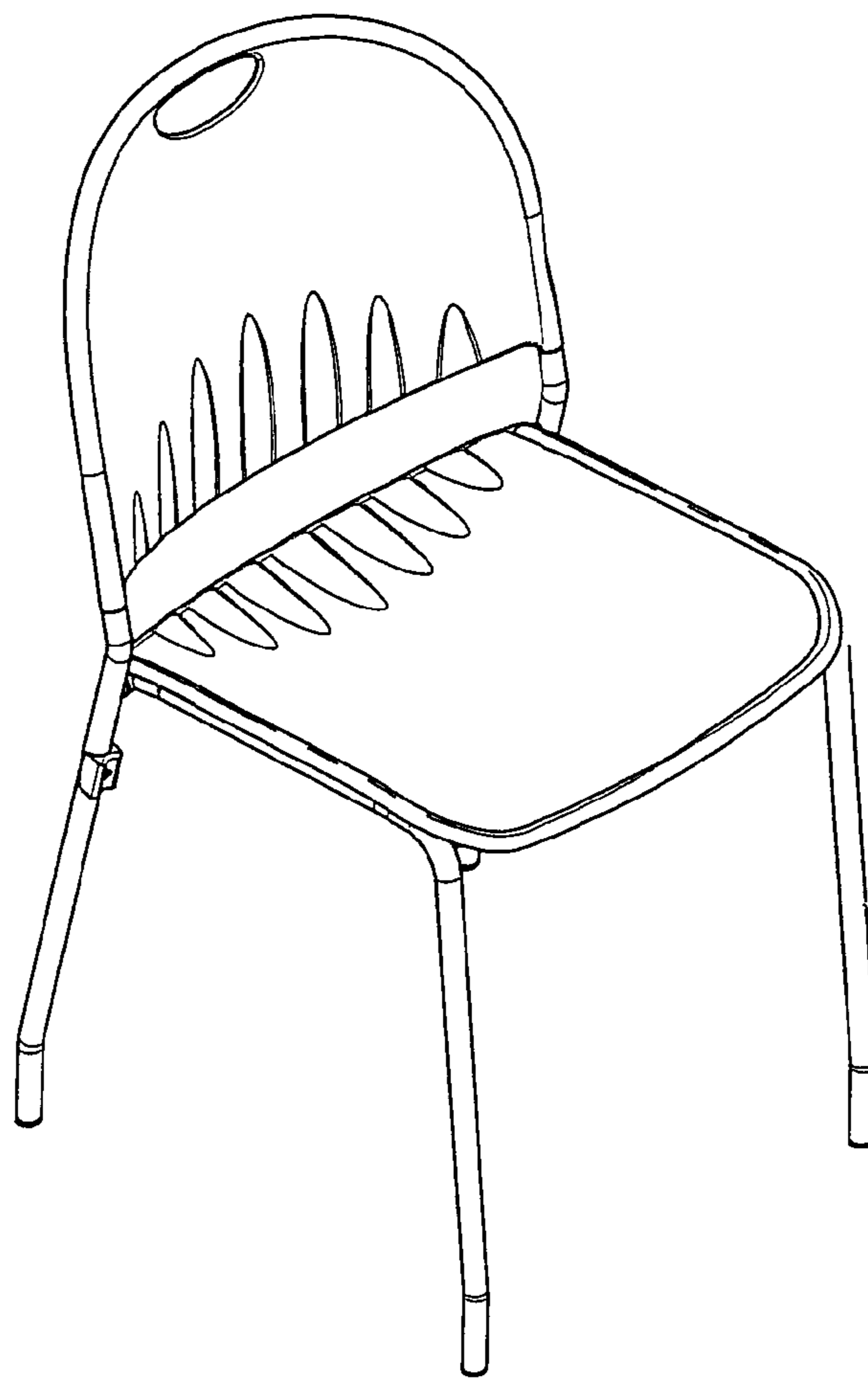

Fig. 1

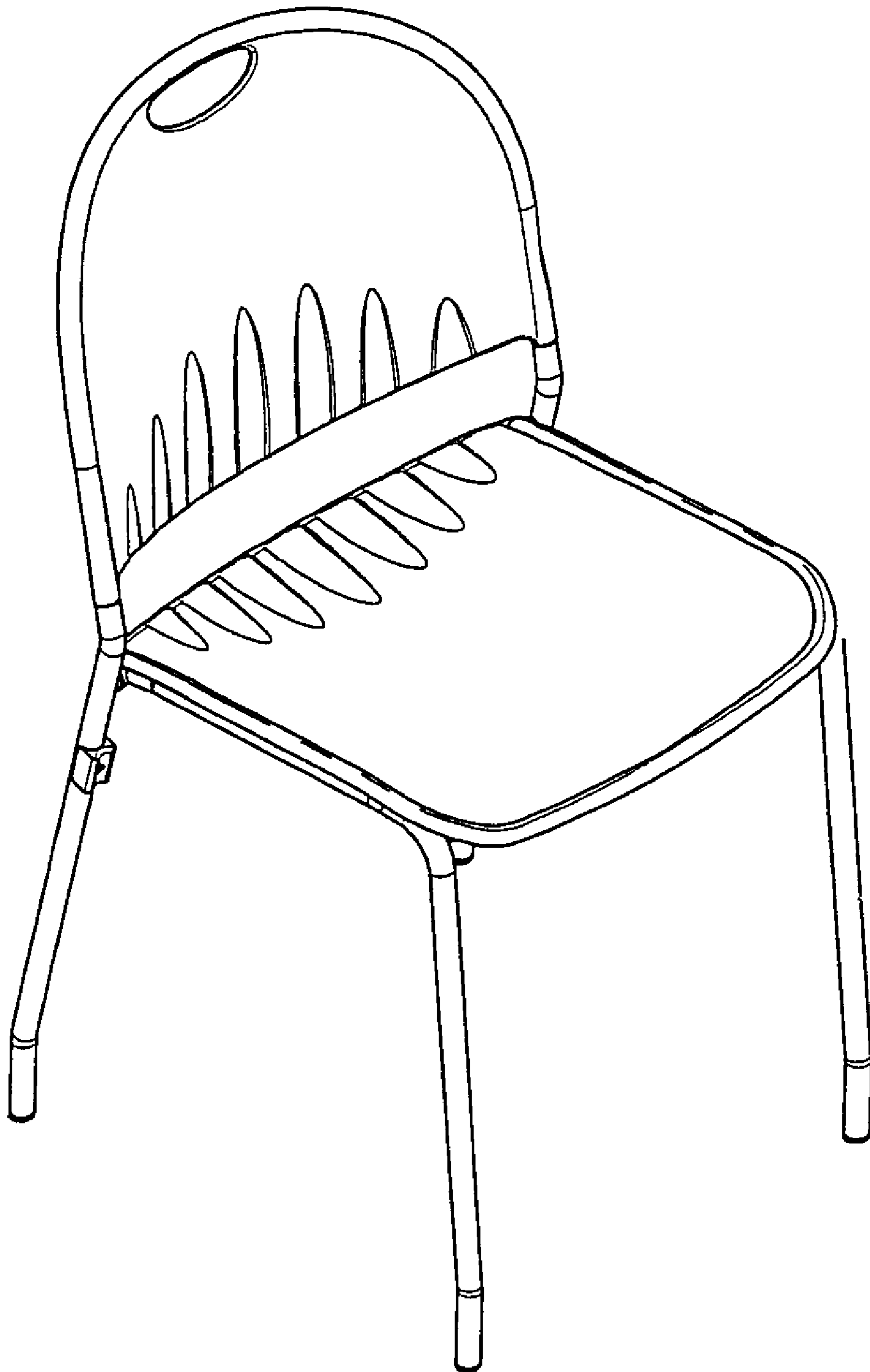

Fig. 2

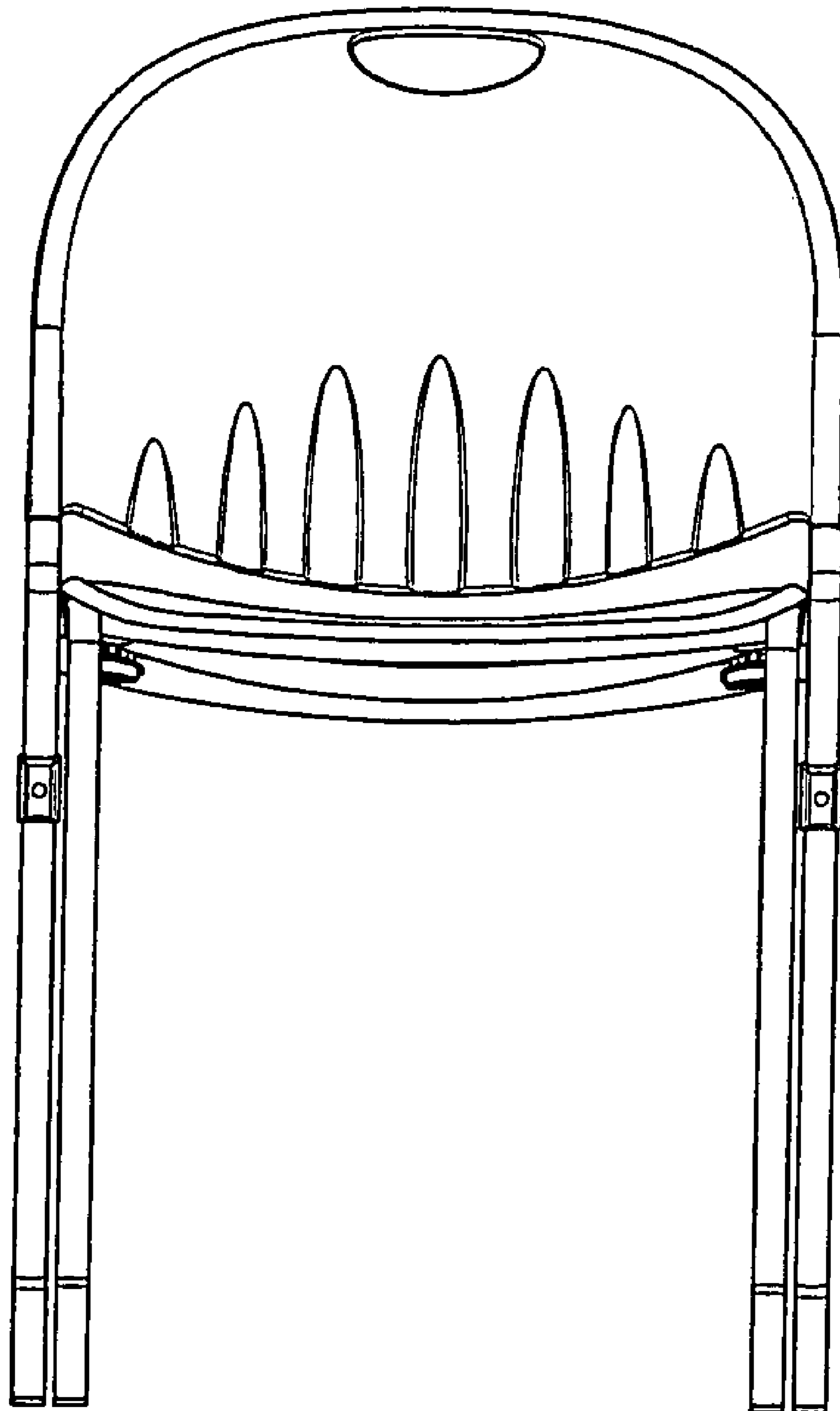

Fig. 3

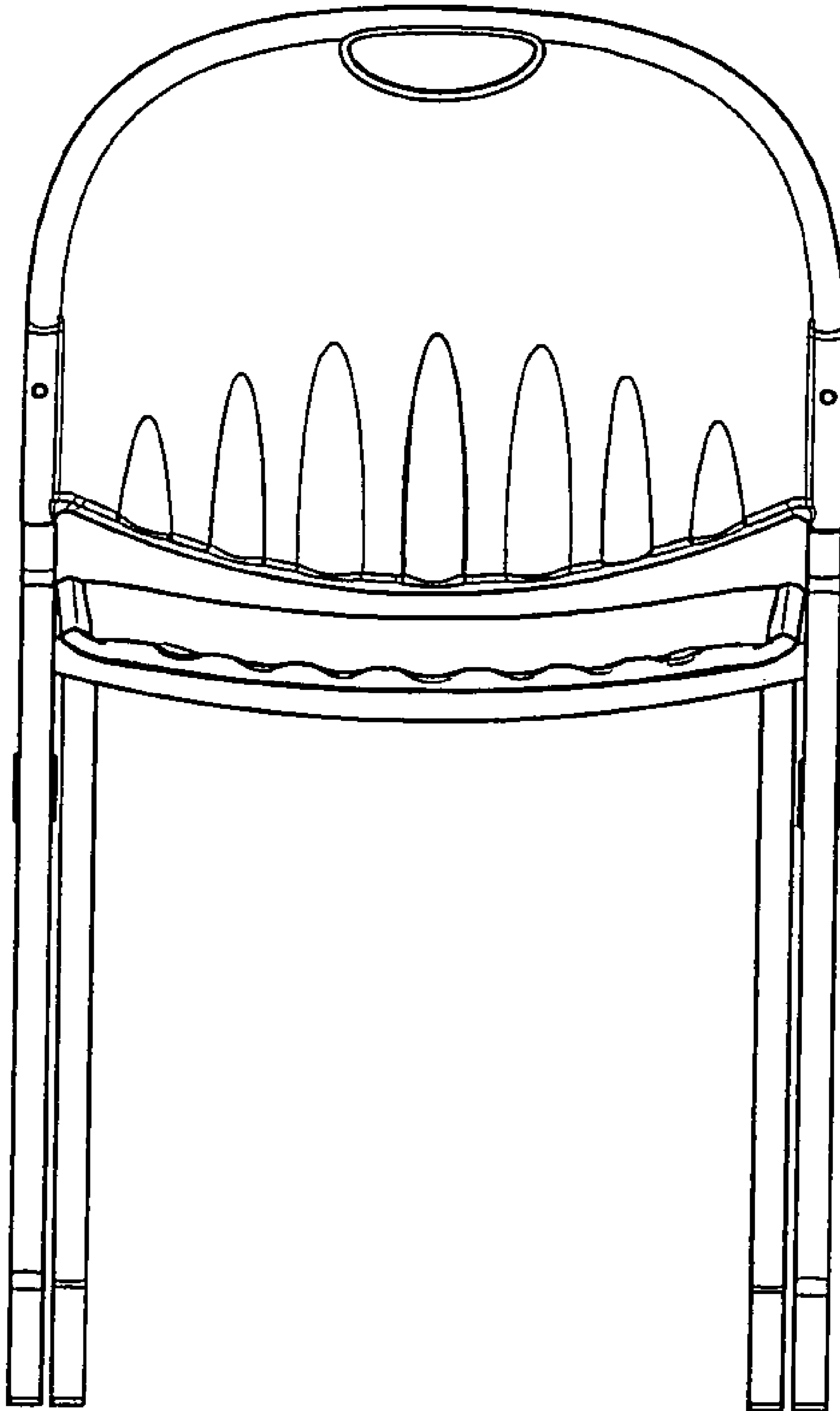

Fig. 4

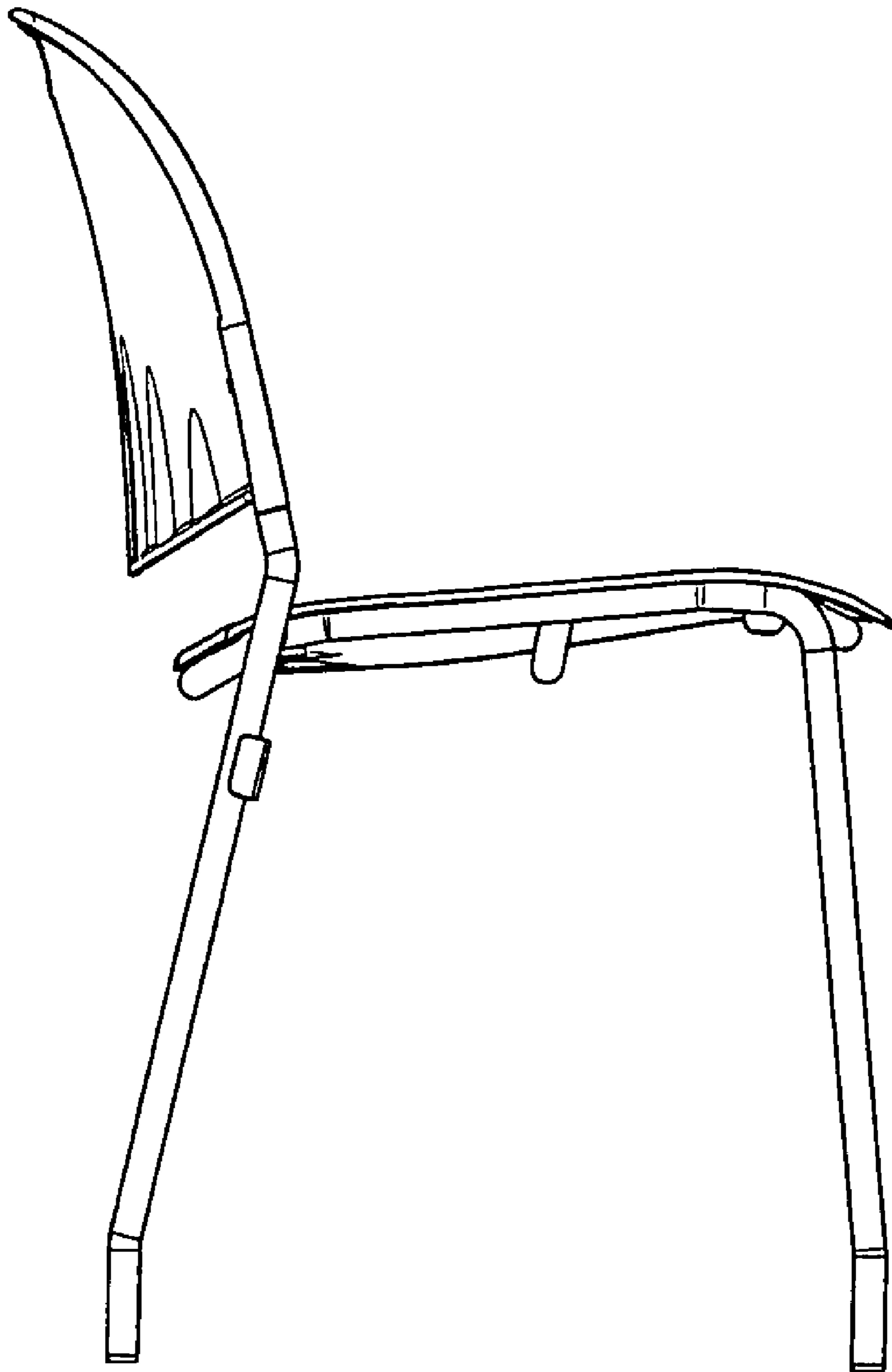

Fig. 5

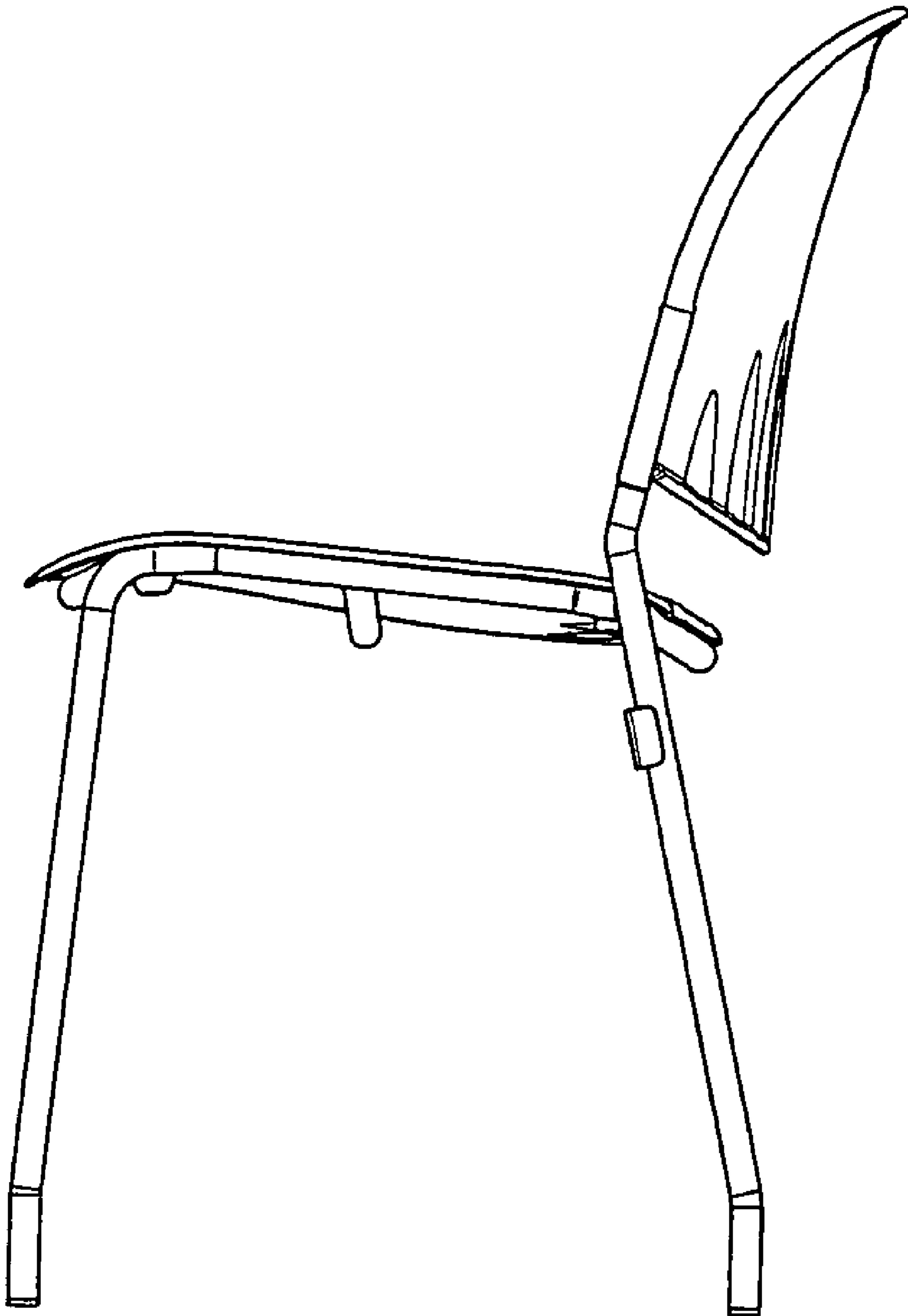

Fig. 6

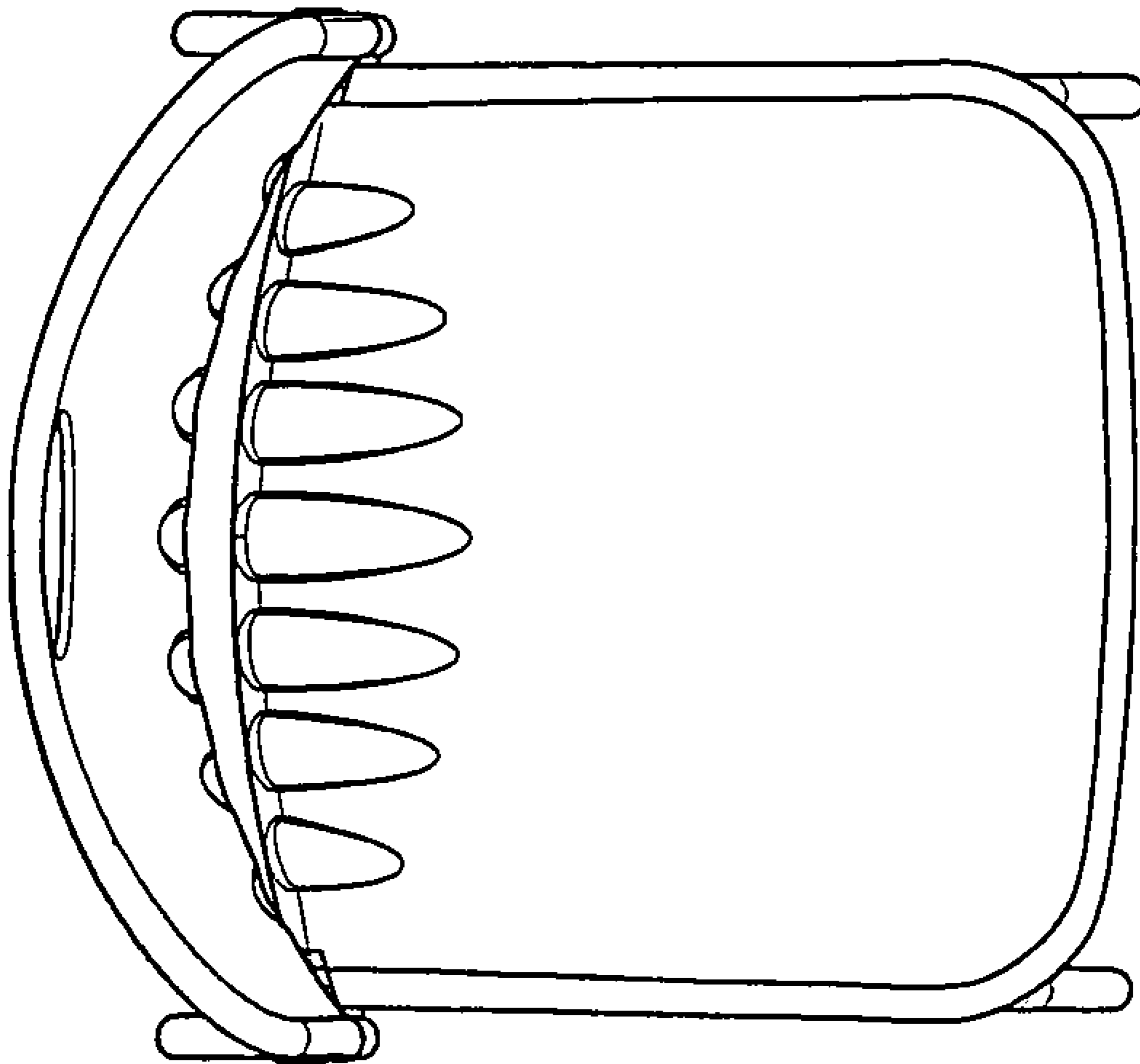

Fig. 7

