



US00D552858S

(12) **United States Design Patent**
Hock

(10) **Patent No.:** **US D552,858 S**

(45) **Date of Patent:** **** Oct. 16, 2007**

(54) **CHAIR**

(76) Inventor: **Koh Tuang Hock**, 235 Chung-Ho Box
8-24, Taipei (TW)

(**) Term: **14 Years**

(21) Appl. No.: **29/272,241**

(22) Filed: **Feb. 5, 2007**

(51) **LOC (8) Cl.** **06-01**

(52) **U.S. Cl.** **D6/373**

(58) **Field of Classification Search** D6/334-336,
D6/341, 371-376, 379, 380, 500-502; 297/239,
297/411.43, 445.1, 447.3, 448.1, 448.2, 451.7,
297/452.18

See application file for complete search history.

(56) **References Cited**

U.S. PATENT DOCUMENTS

D202,775 S *	11/1965	Rowland	D6/373
D243,572 S *	3/1977	Offredi	D6/373
D246,813 S *	1/1978	Tolleson	D6/373
D344,418 S *	2/1994	Favaretto	D6/373
D367,185 S *	2/1996	Olson	D6/373

D374,129 S *	10/1996	Timmons	D6/373
D378,553 S *	3/1997	Newhouse	D6/374
D390,024 S *	2/1998	DeJule	D6/380
D433,578 S *	11/2000	Saul	D6/373
D466,712 S *	12/2002	Haney et al.	D6/380

* cited by examiner

Primary Examiner—Mimosa De

(57) **CLAIM**

The ornamental design for a chair, as shown and described.

DESCRIPTION

FIG. 1 is a perspective view of a chair showing my new design.

FIG. 2 is a front elevational view thereof.

FIG. 3 is a rear elevational view thereof.

FIG. 4 is a left side view thereof;

FIG. 5 is a right side view thereof.

FIG. 6 is a top plan view thereof; and,

FIG. 7 is a bottom plan view thereof.

1 Claim, 7 Drawing Sheets

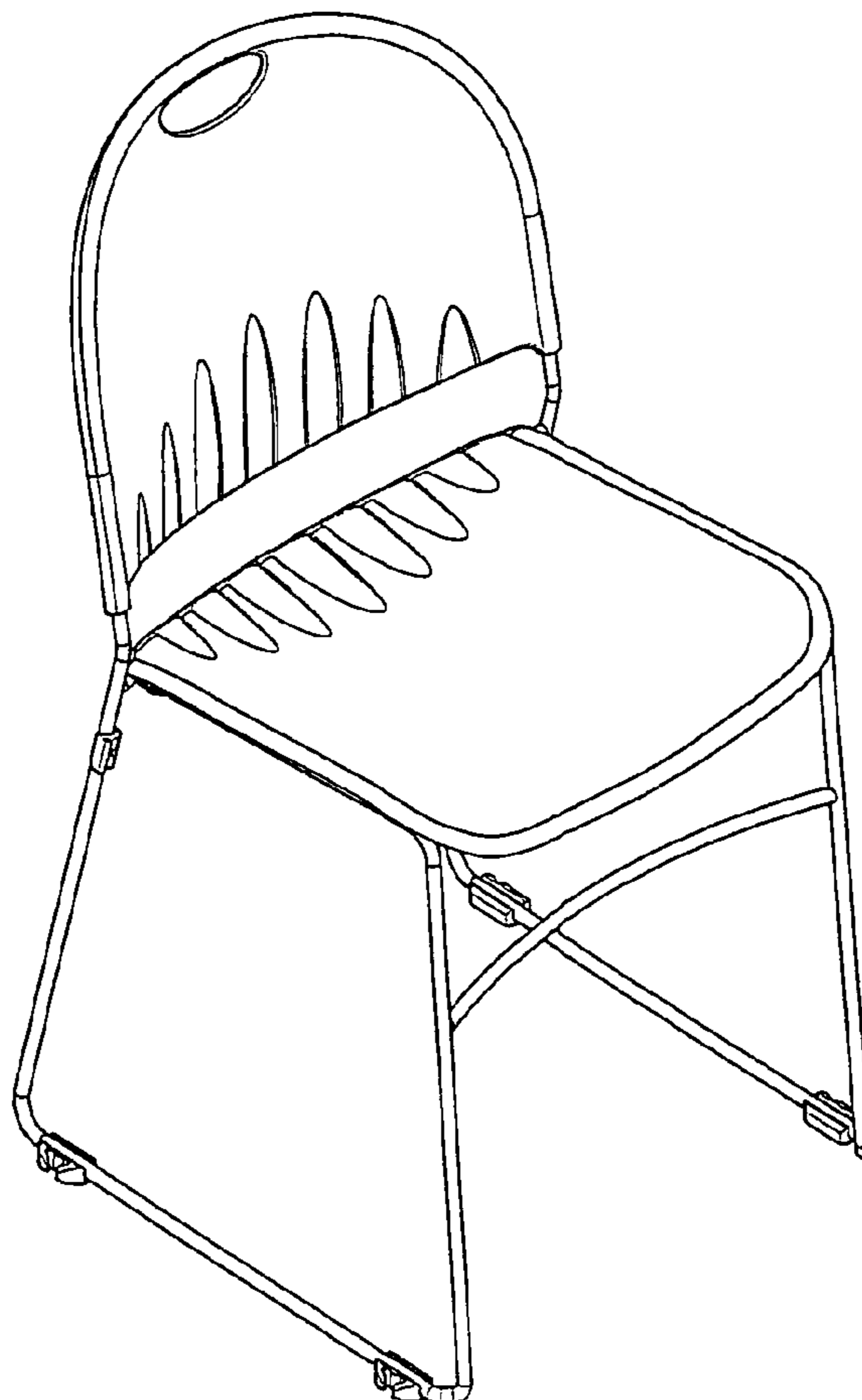

Fig. 1

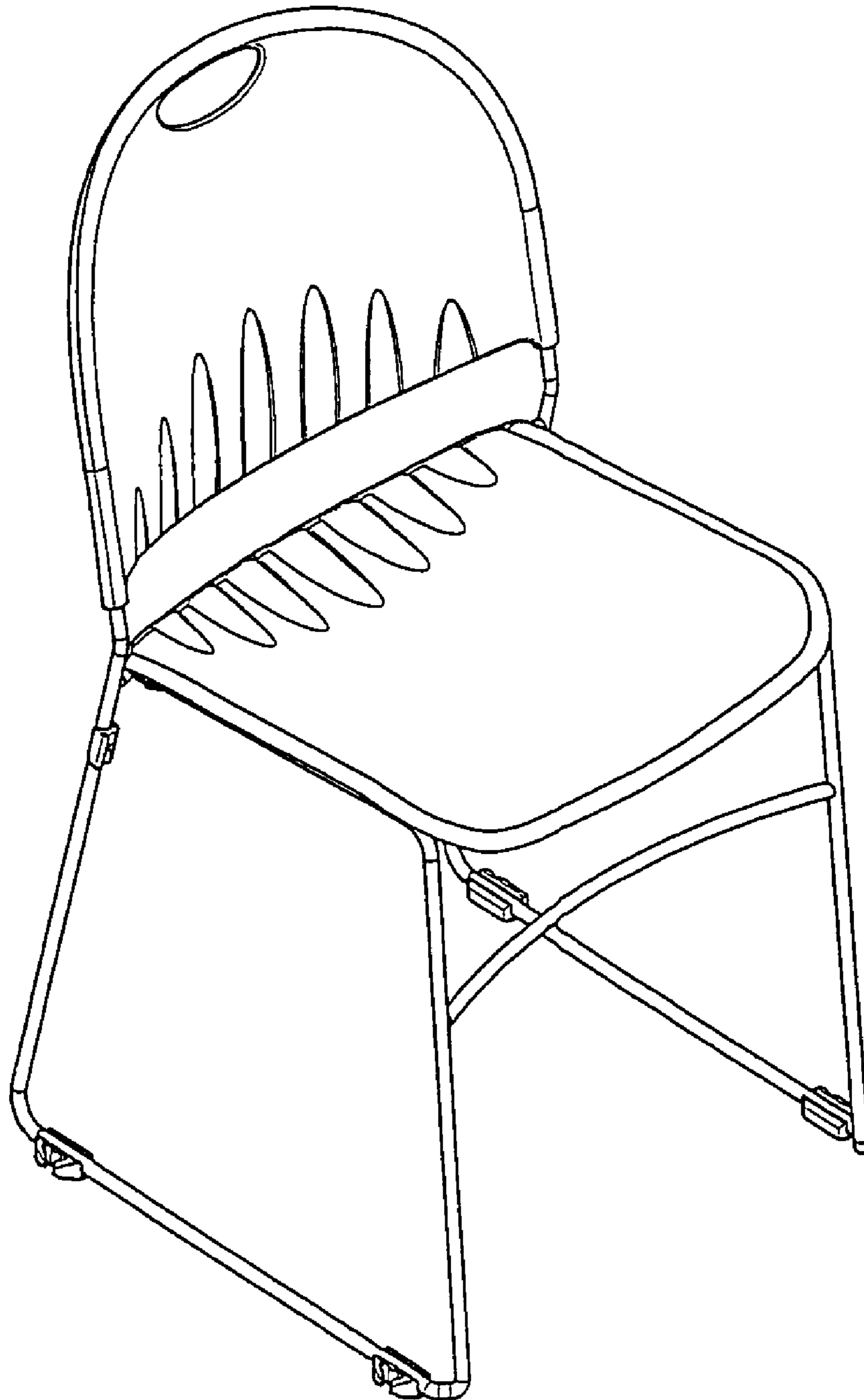

Fig. 2

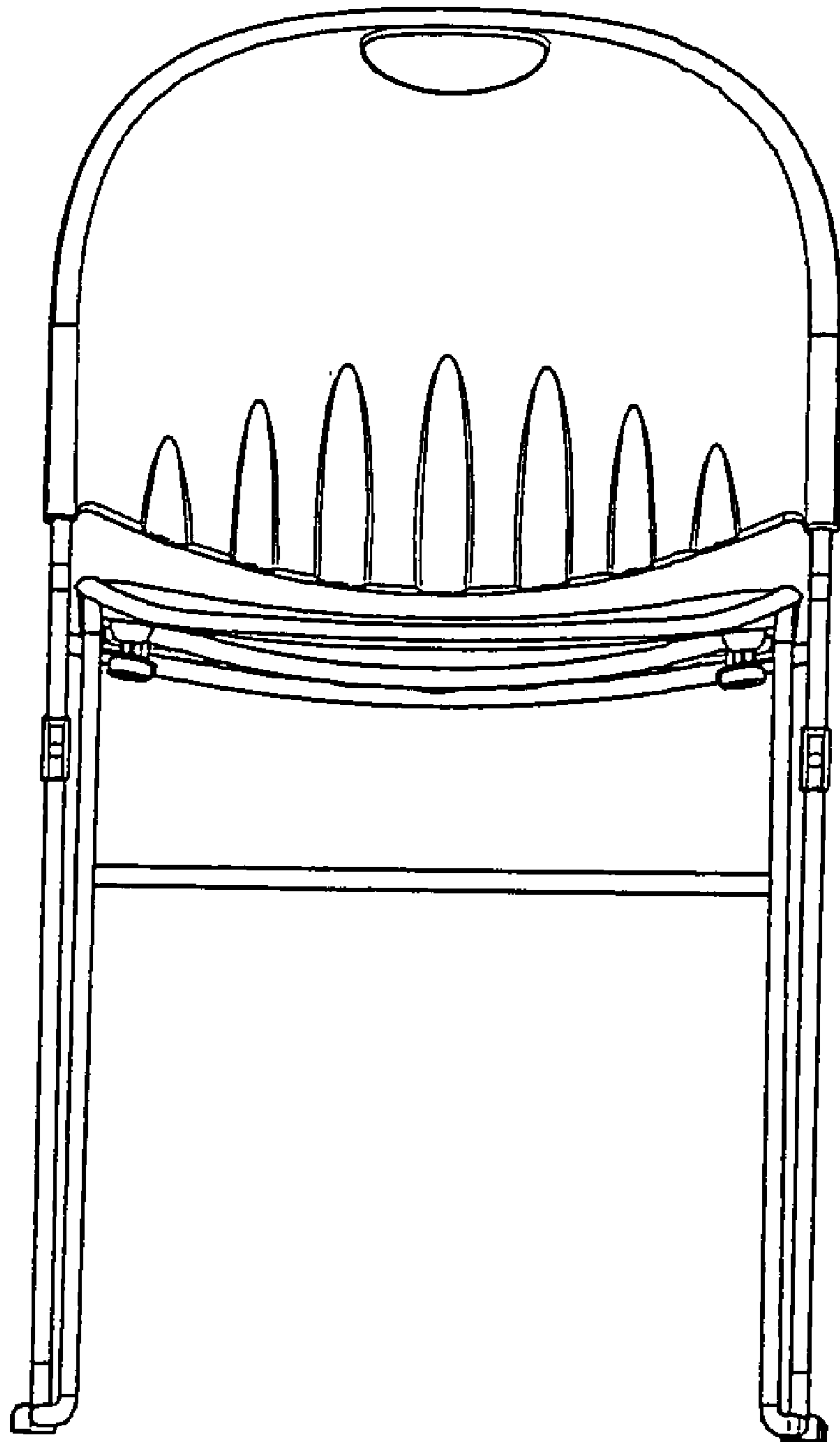

Fig. 3

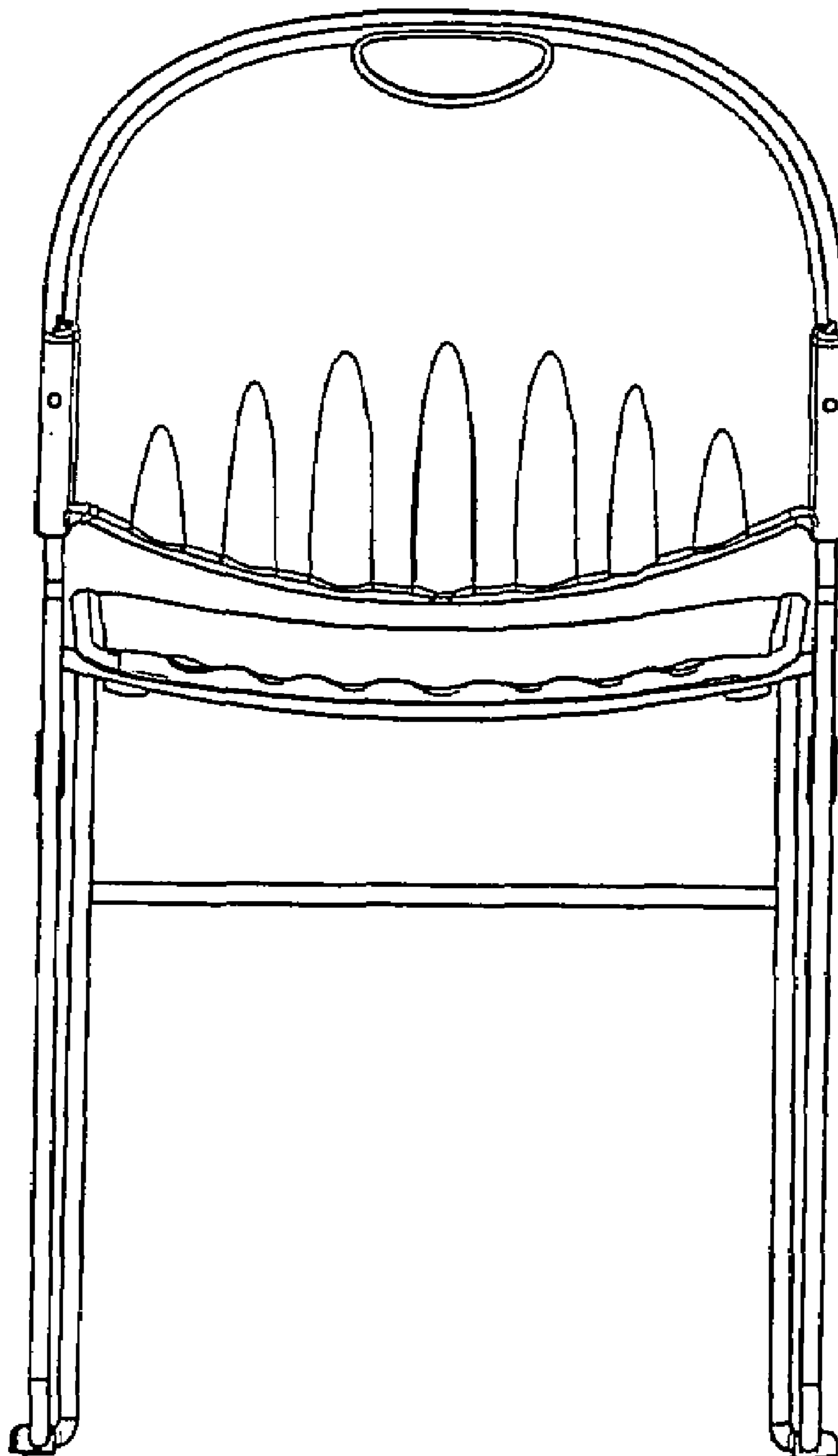

Fig. 4

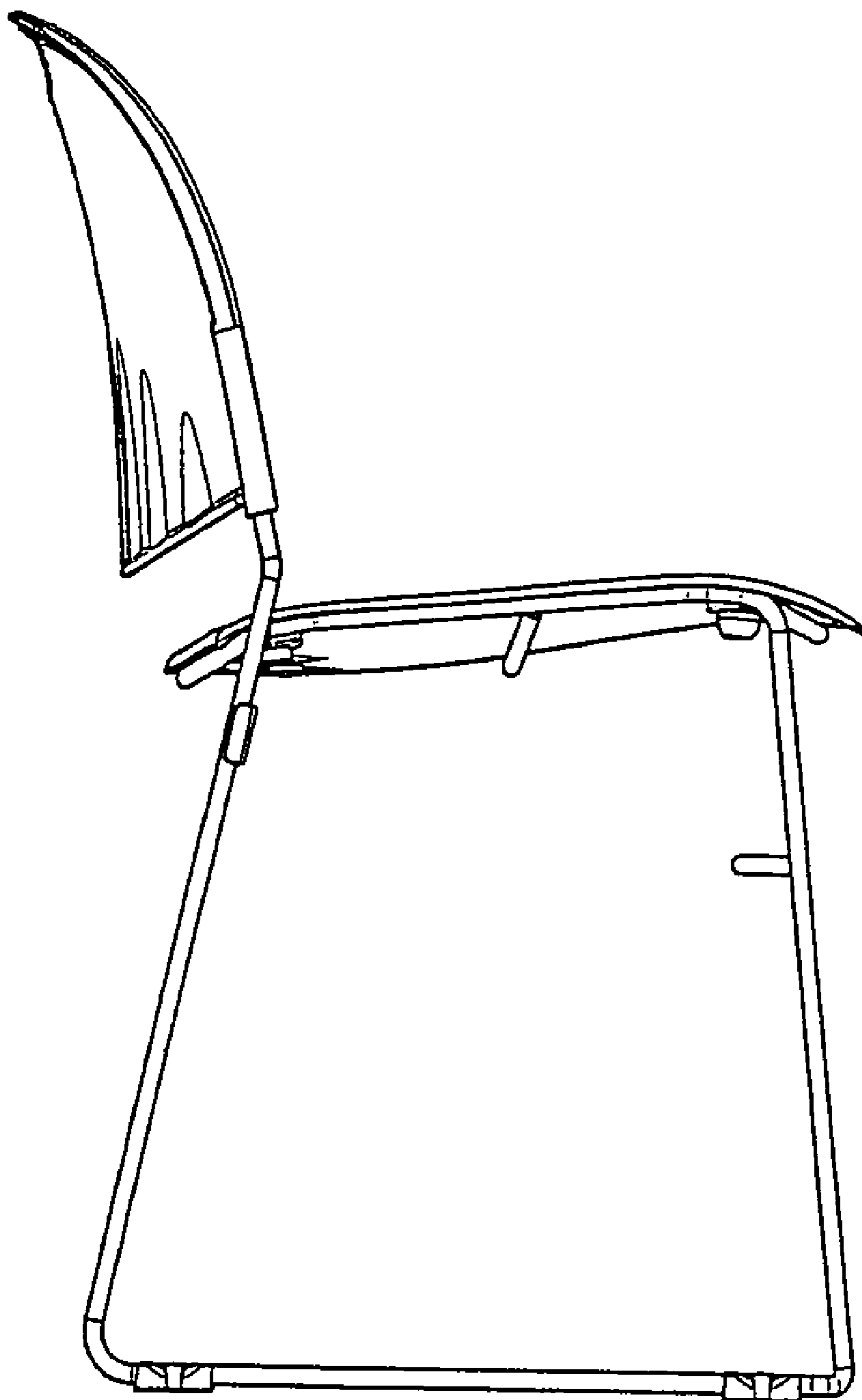

Fig. 5

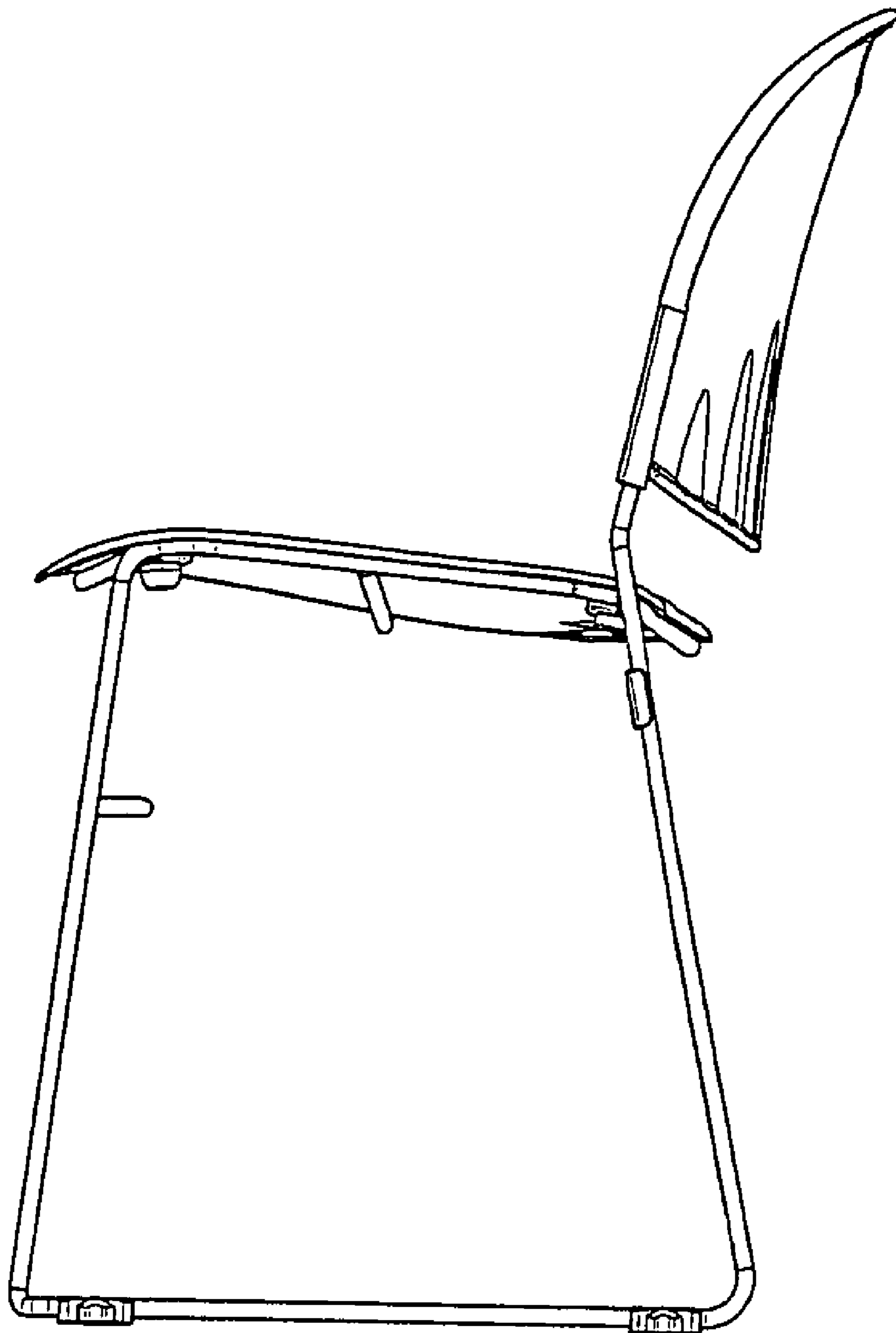

Fig. 6

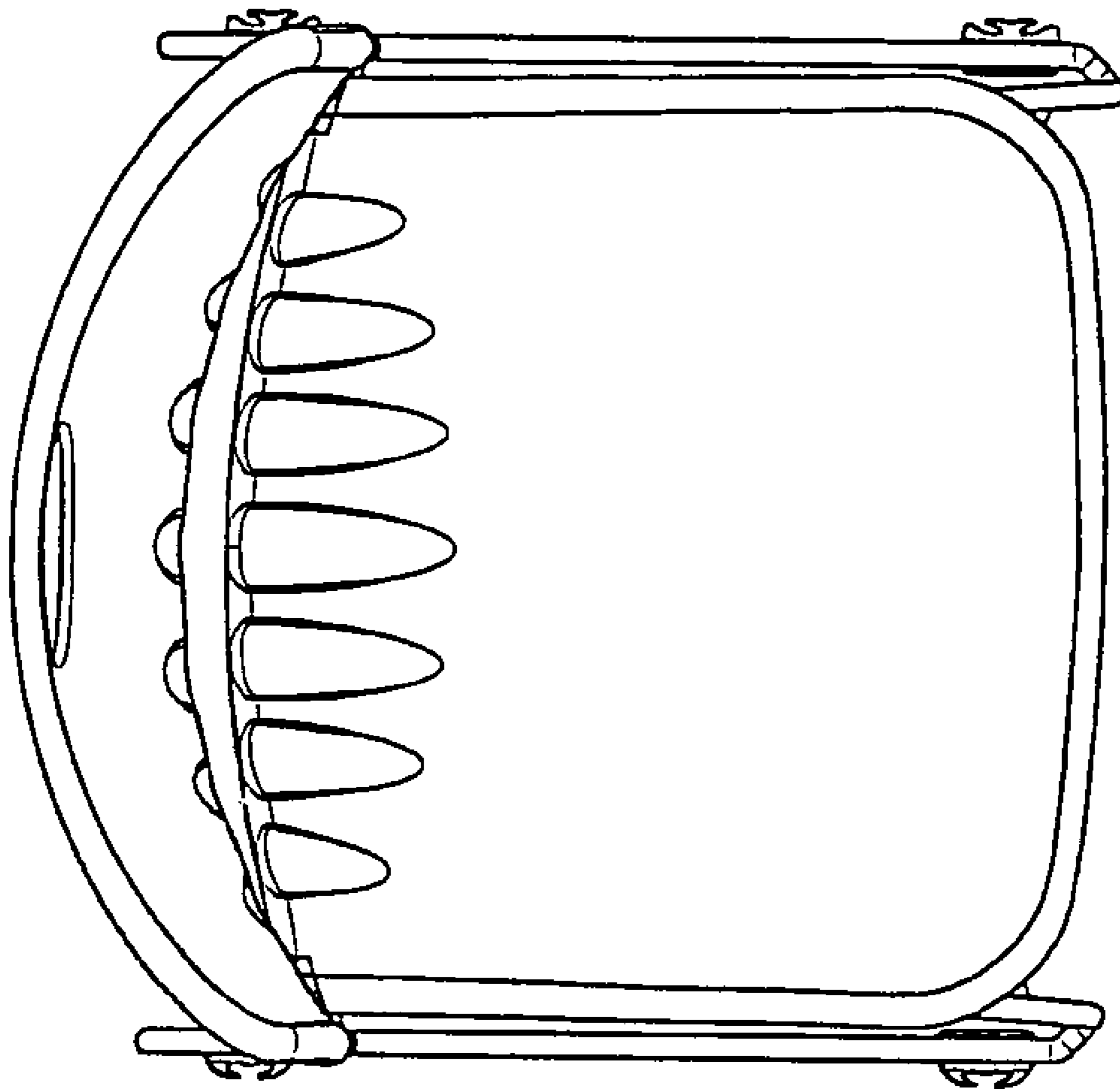

Fig. 7

