



US00D552730S

(12) **United States Design Patent**
Collins et al.

(10) **Patent No.:** **US D552,730 S**
(45) **Date of Patent:** **** Oct. 9, 2007**

(54) **DISPENSER FOR DISPENSING A FLUID INTO A NASAL CAVITY**

(75) Inventors: **Matthew Spencer Collins**, Henlow (GB); **Hugh Alexander Connell**, Evesham (GB); **Michael Birsha Davies**, Ware (GB); **Andrew Robert Gibbs**, Leamington Spa (GB); **Paul Kenneth Rand**, Ware (GB); **Robert William Tansley**, Bidford on Avon (GB)

(73) Assignee: **Glaxo Group Limited**, Greenford (GB)

(**) Term: **14 Years**

(21) Appl. No.: **29/250,174**

(22) Filed: **Nov. 6, 2006**

Related U.S. Application Data

(62) Division of application No. 29/204,249, filed on Apr. 27, 2004.

(30) **Foreign Application Priority Data**

Oct. 31, 2003 (GB) 3015000

(51) **LOC (8) Cl.** **29-02**

(52) **U.S. Cl.** **D24/110; D9/724; D24/115**

(58) **Field of Classification Search** D24/110, D24/114, 115, 130, 113, 133, 147, 135; D9/530, D9/539, 549, 723-730; D3/201, 203.1; D28/7, D28/9; 239/338; 222/206, 211, 213, 215, 222/214, 464.7; 604/19, 37, 94.01
See application file for complete search history.

(56) **References Cited**

U.S. PATENT DOCUMENTS

- D176,226 S * 11/1955 Morris D9/558
- D251,203 S * 2/1979 Williamson D24/114
- D414,261 S * 9/1999 Ritsche D24/110
- D438,459 S * 3/2001 Holthaus D9/728
- D447,230 S * 8/2001 Matsugi et al. D24/110

- 6,745,760 B2 * 6/2004 Grychowski et al. .. 128/200.14
- D498,681 S * 11/2004 Fenton et al. D9/558
- D527,640 S * 9/2006 Cummings et al. D9/558
- D527,817 S * 9/2006 Ziegler et al. D24/110
- 2006/0137683 A1 * 6/2006 Anderson et al. 128/200.14

* cited by examiner

Primary Examiner—Ian Simmons

Assistant Examiner—W. Laymon

(74) *Attorney, Agent, or Firm*—James P. Riek

(57) **CLAIM**

The ornamental design for a dispenser for dispensing a fluid into a nasal cavity, as shown and described.

DESCRIPTION

FIG. 1 is a perspective view from above of one side and one end of the dispenser for dispensing a fluid into a nasal cavity showing our new design;

FIG. 2 is a perspective view from below of opposite side and opposite end thereof;

FIG. 3 is a perspective view from above of one side and one end with parts separated thereof;

FIG. 4 is perspective view from below of the opposite side and opposite end with parts separated thereof;

FIG. 5 is a side view thereof;

FIG. 6 is an end view thereof;

FIG. 7 is a plan view thereof;

FIG. 8 is a side view with parts separated thereof;

FIG. 9 is an end view with parts separated thereof;

FIG. 10 is an opposite side view thereof;

FIG. 11 is an opposite end view thereof;

FIG. 12 is an underneath plan view thereof;

FIG. 13 is an opposite side view with parts separated thereof; and,

FIG. 14 is an opposite end view with parts separated thereof.

1 Claim, 6 Drawing Sheets

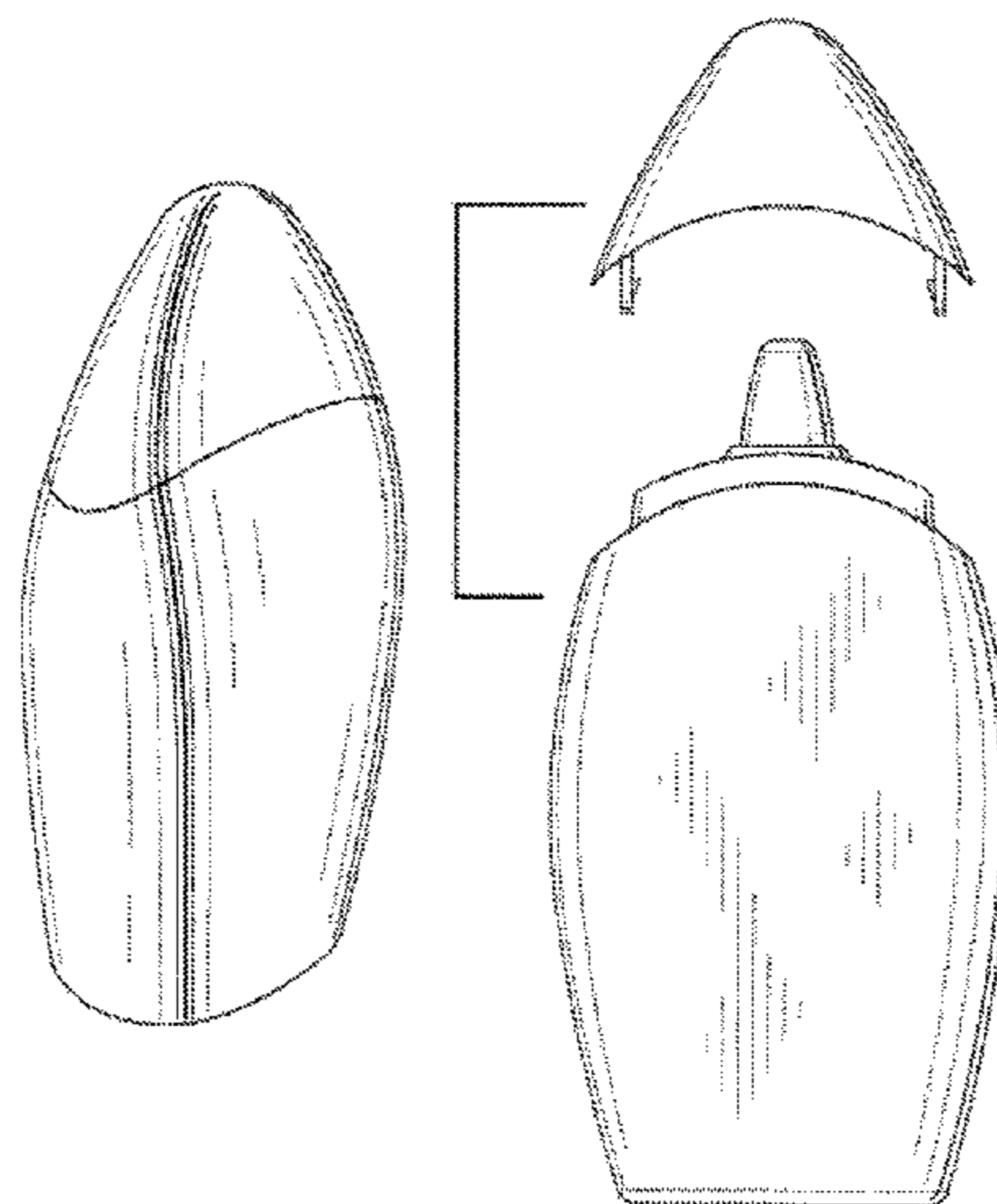

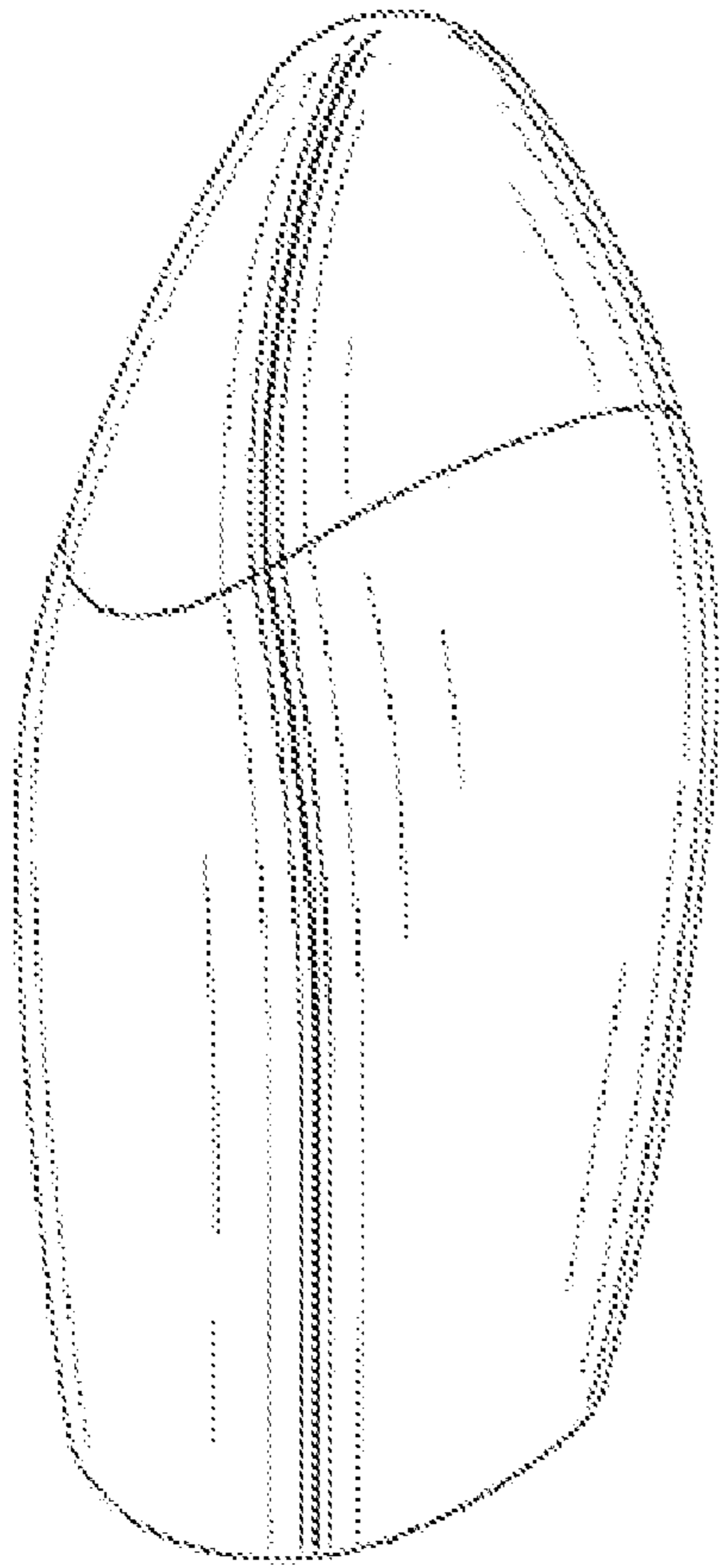

Fig. 1

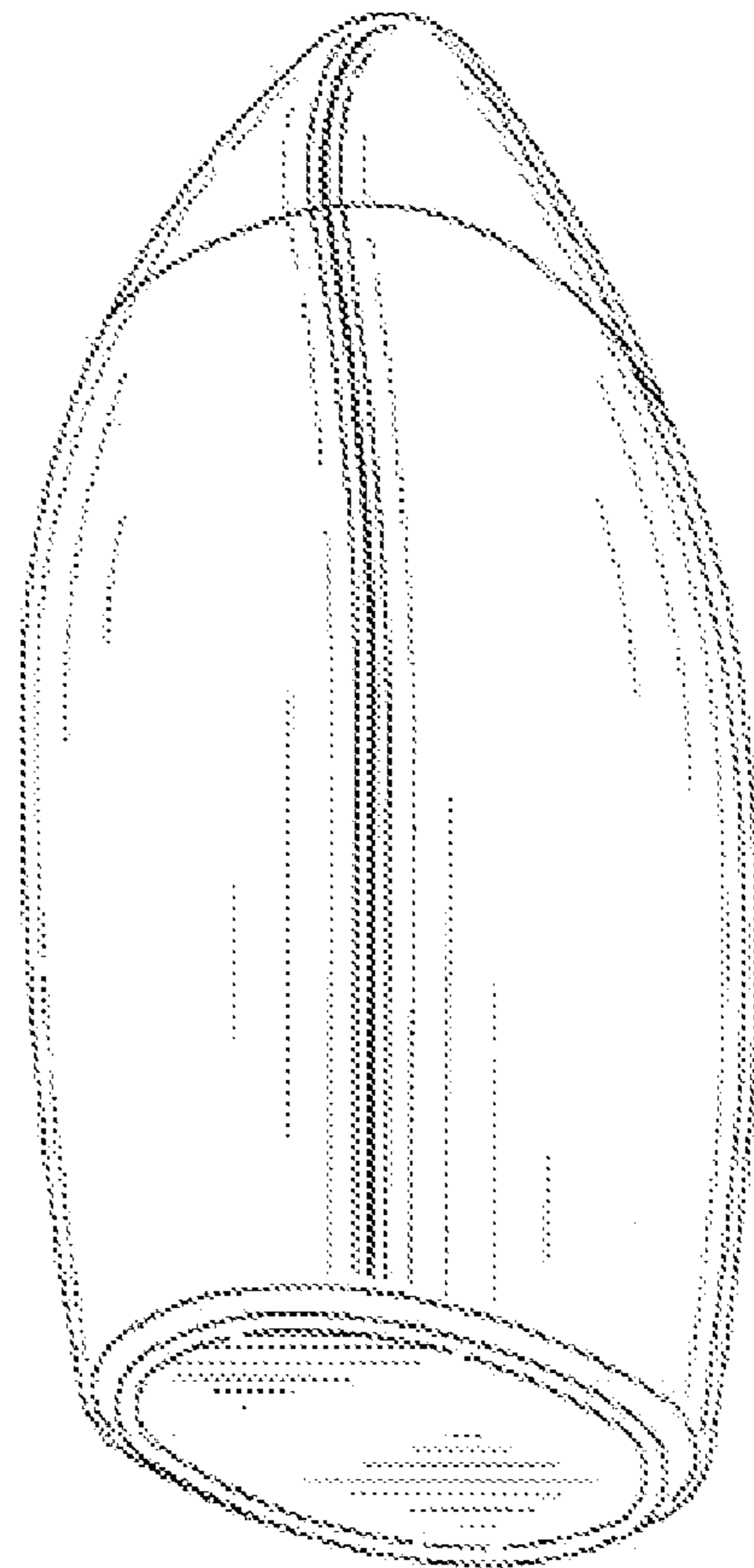

Fig. 2

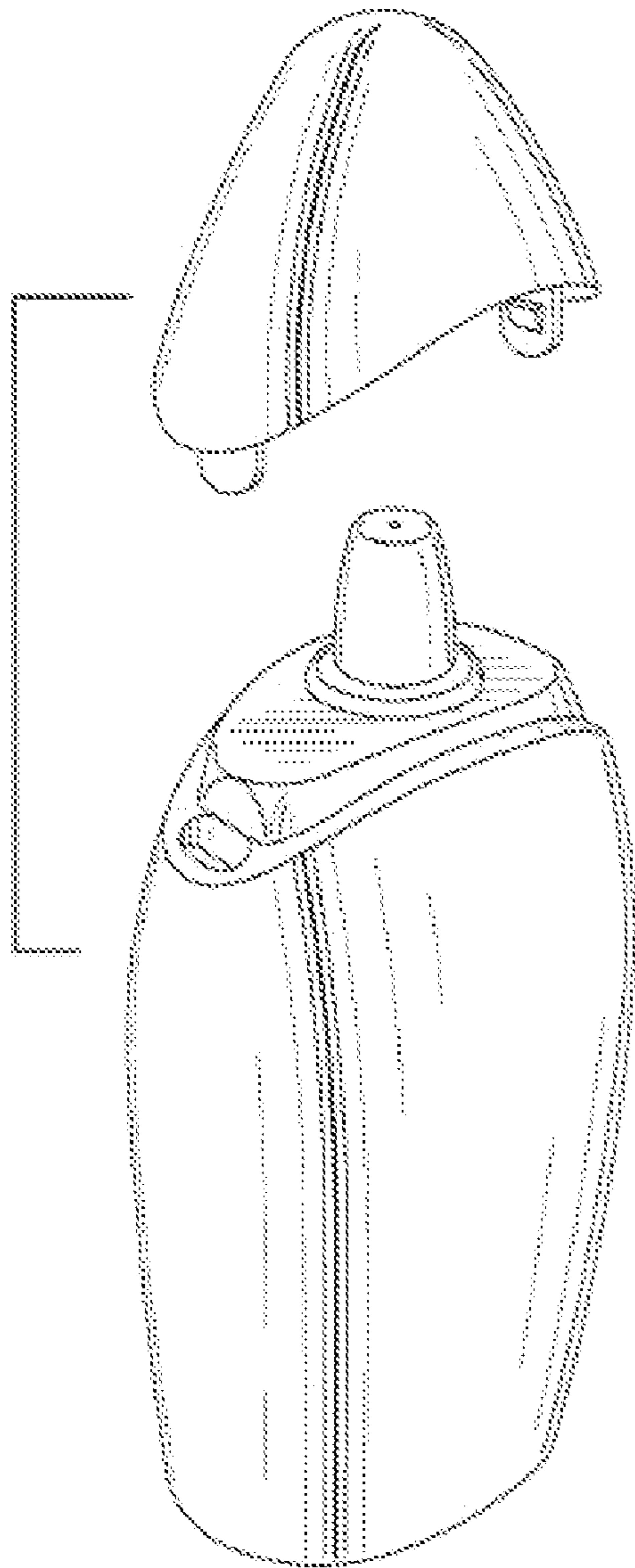

Fig.3

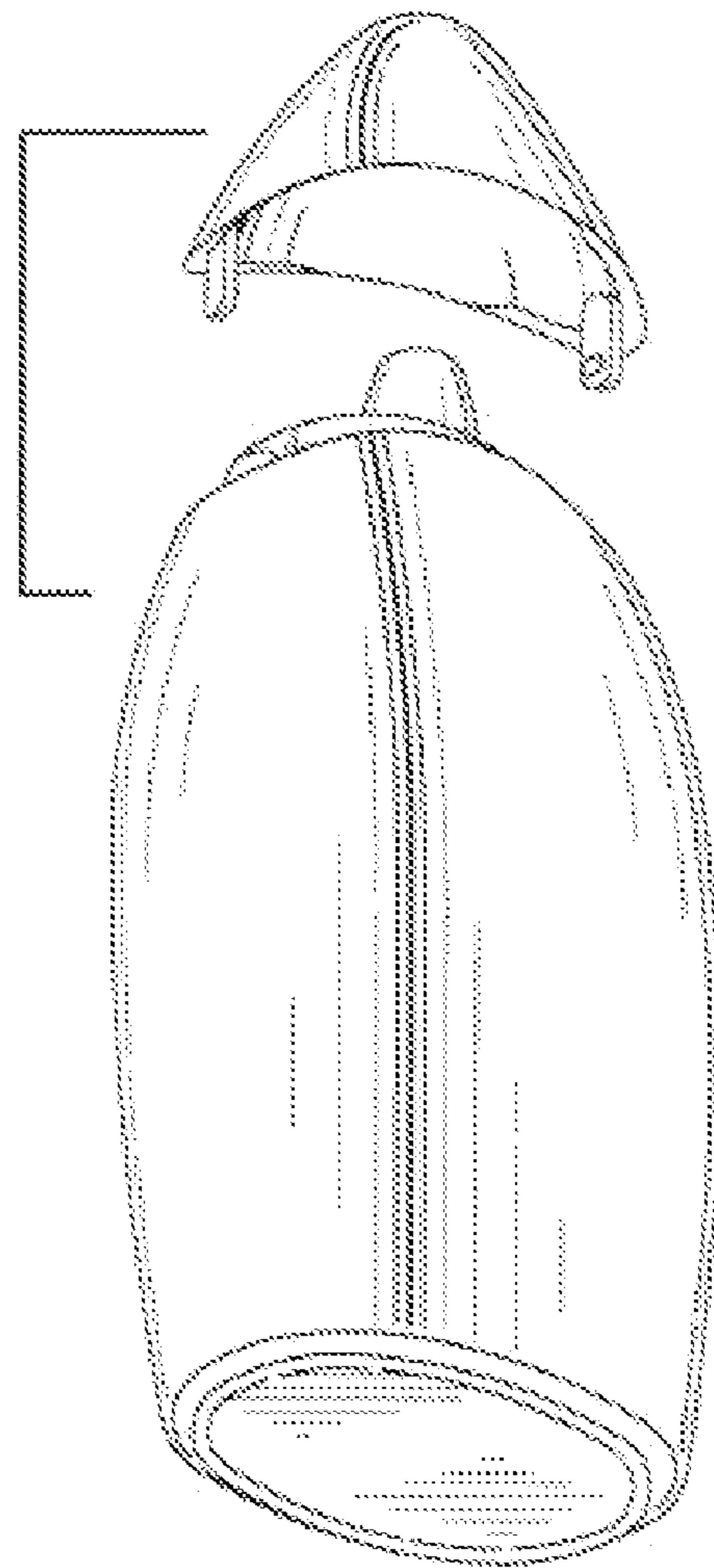

Fig.4

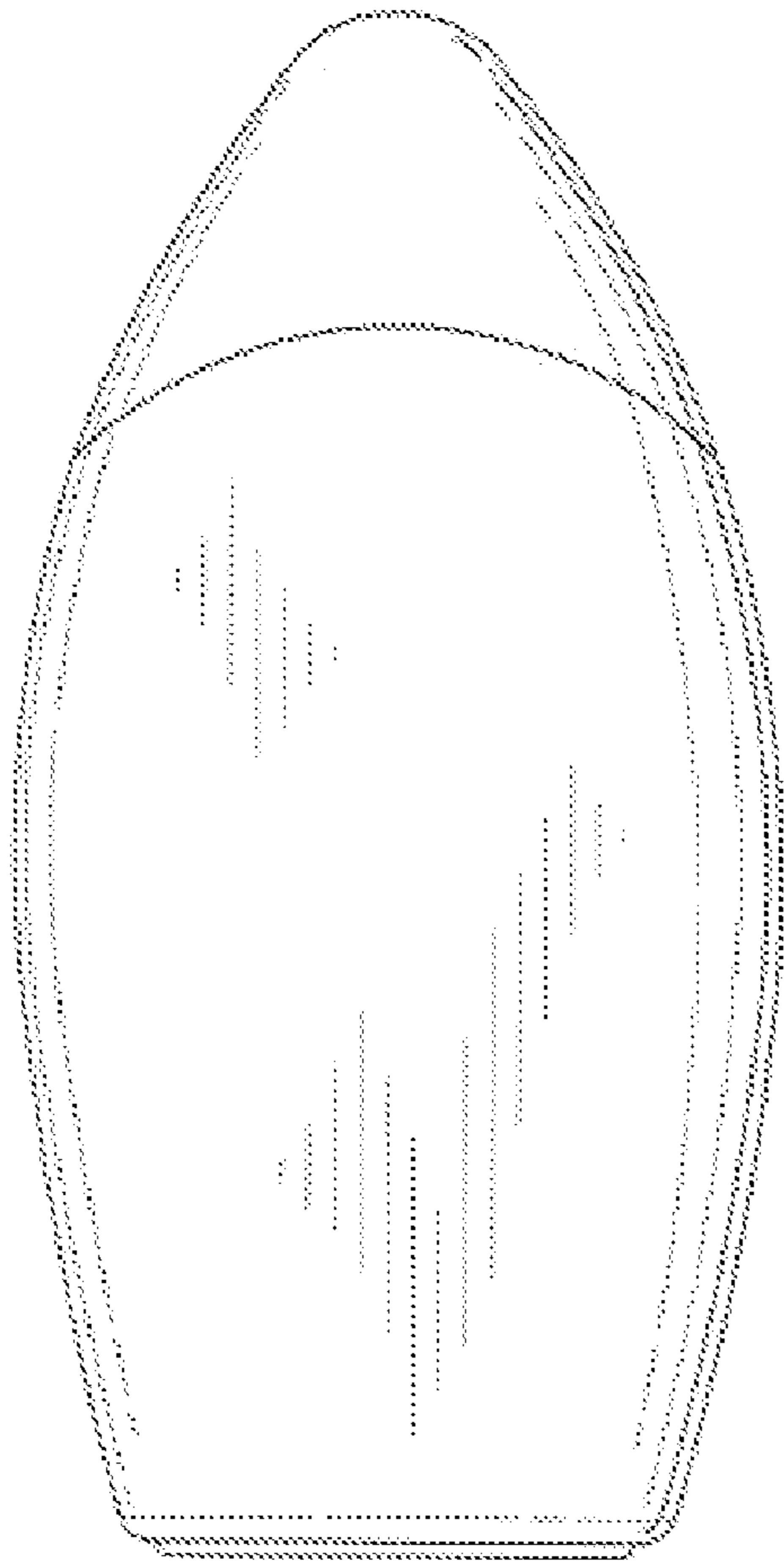

Fig.5

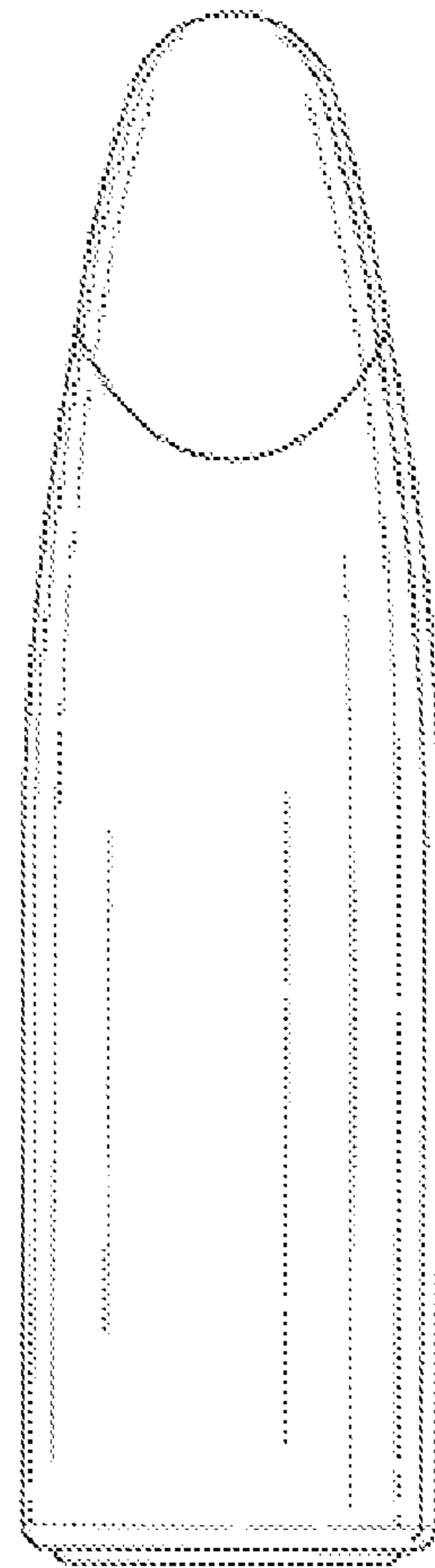

Fig.6

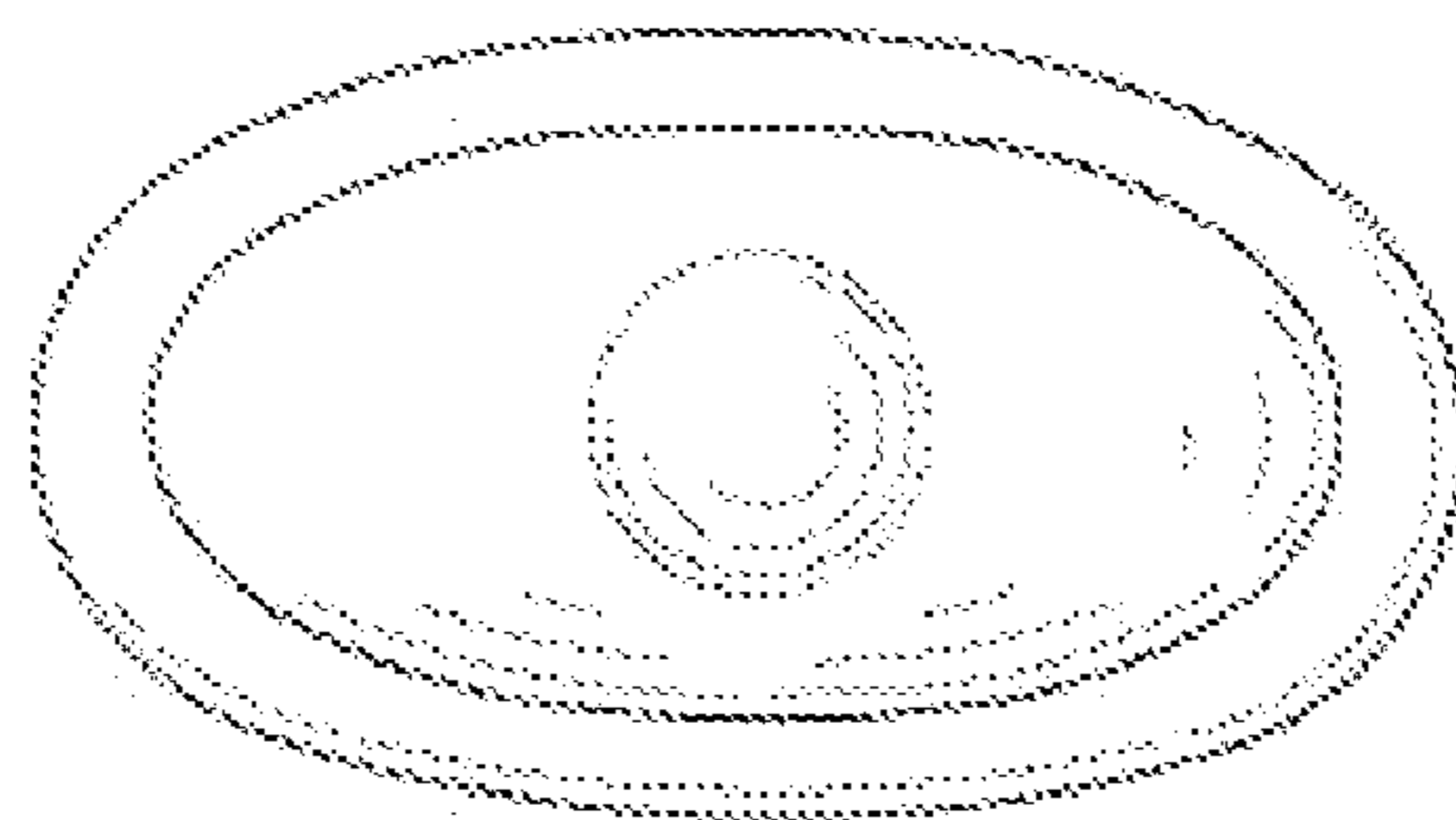

Fig.7

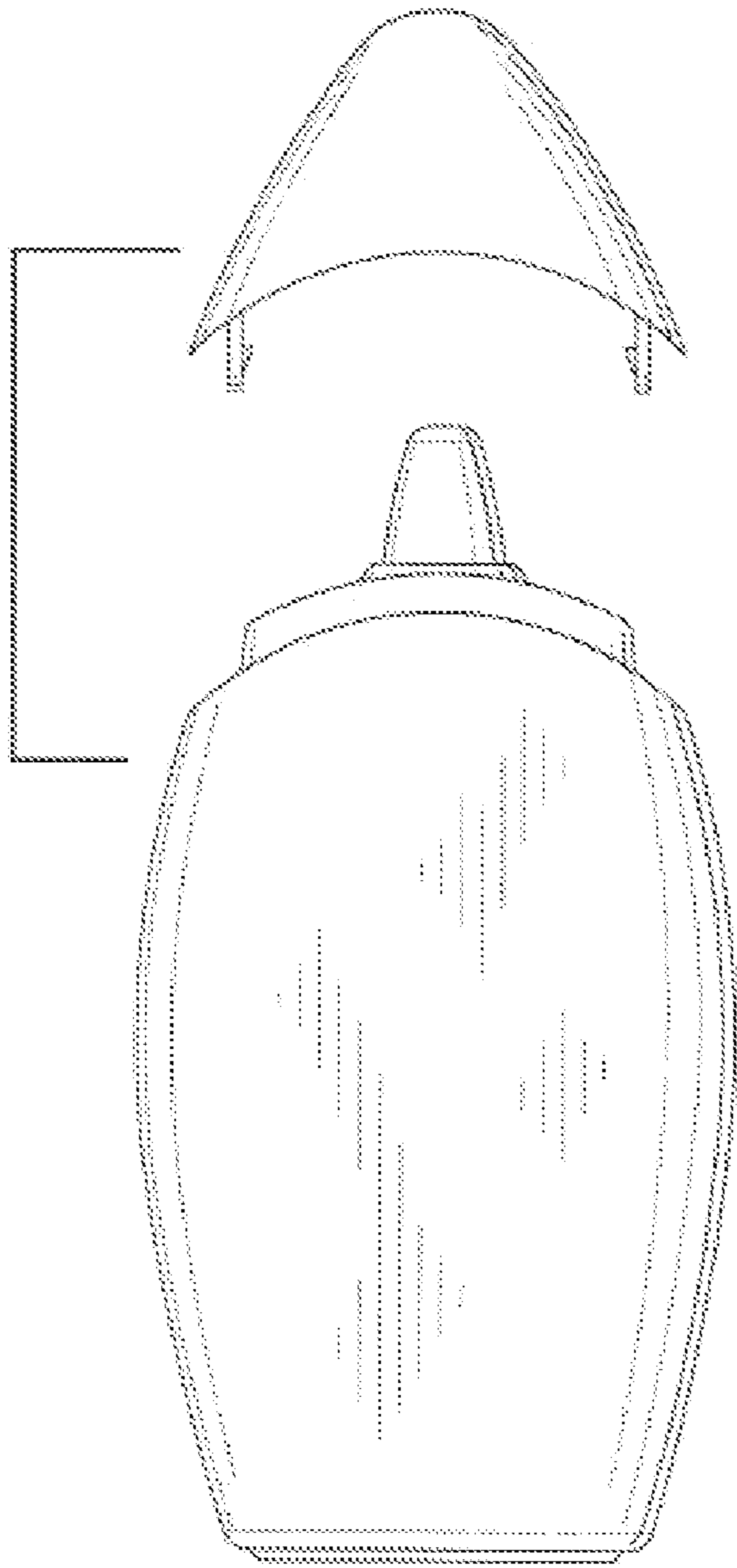

Fig. 8

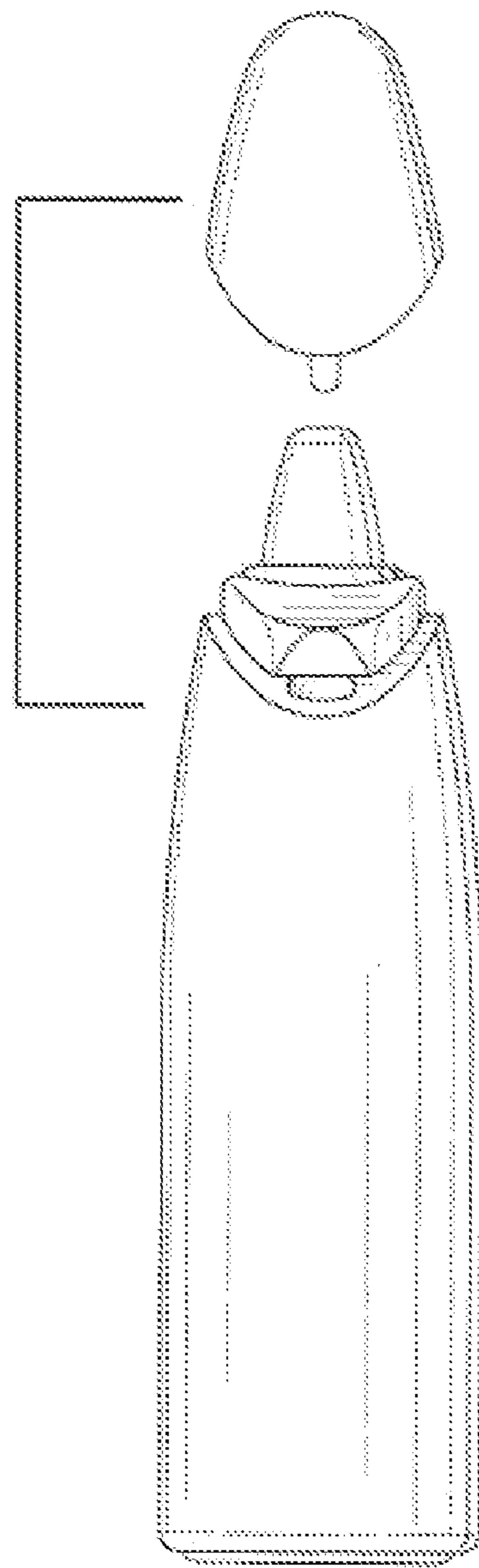

Fig. 9

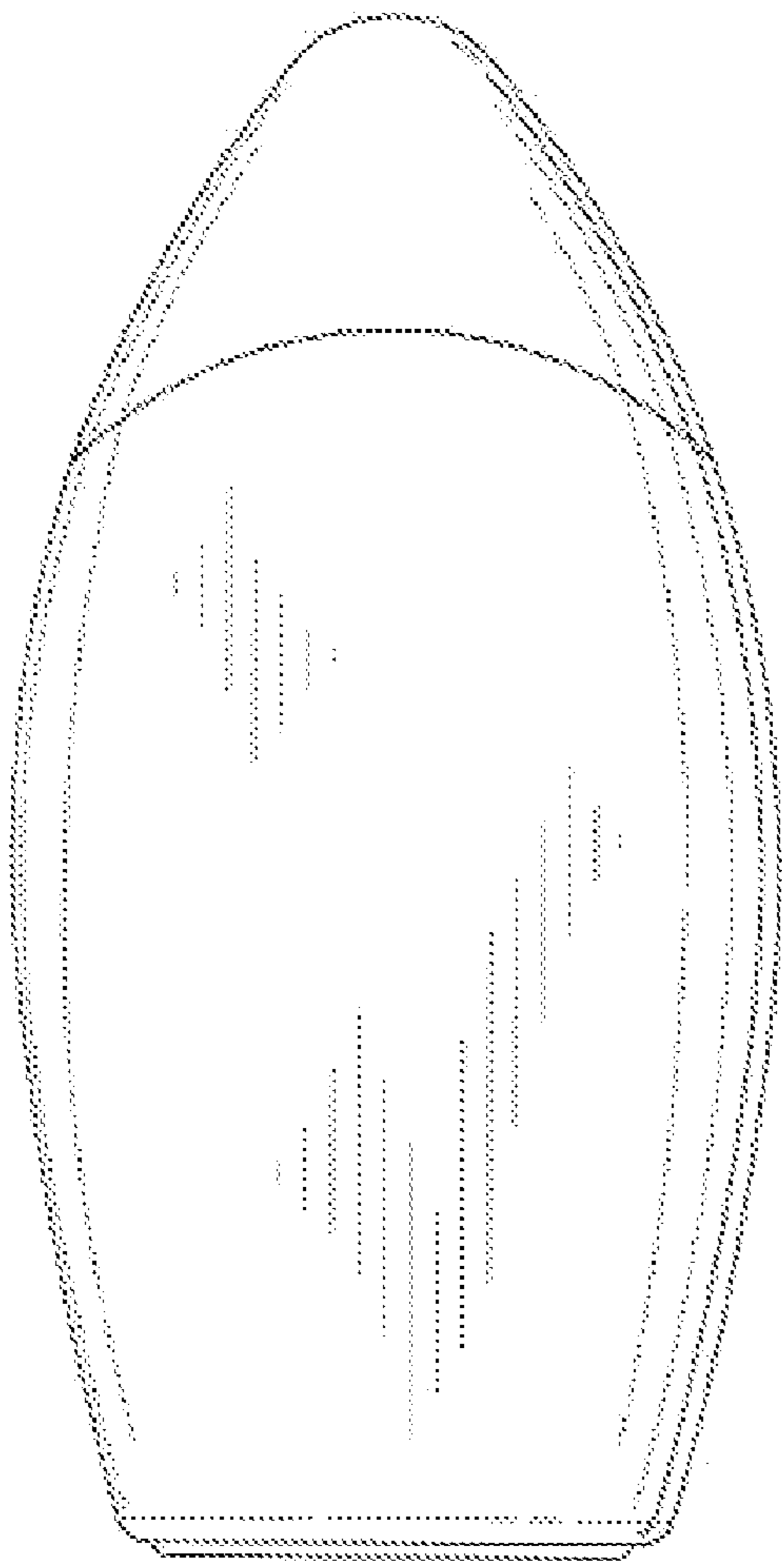

Fig. 10

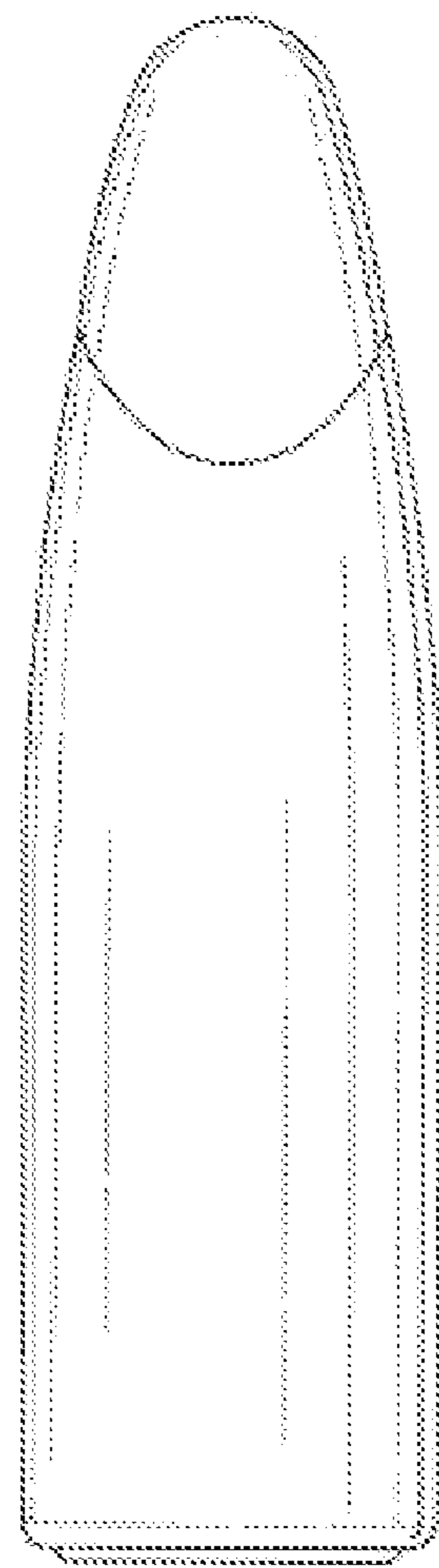

Fig. 11

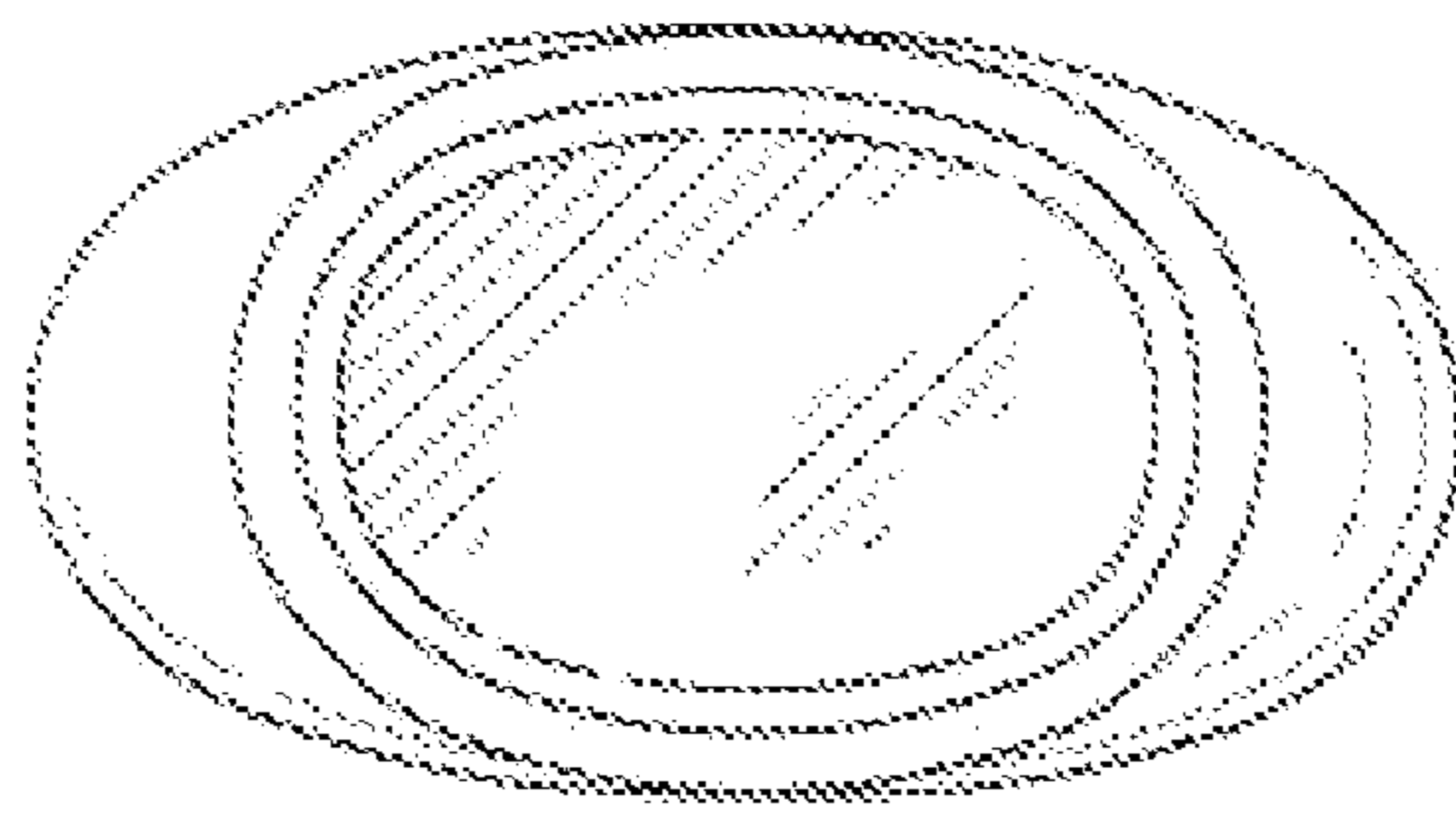

Fig. 12

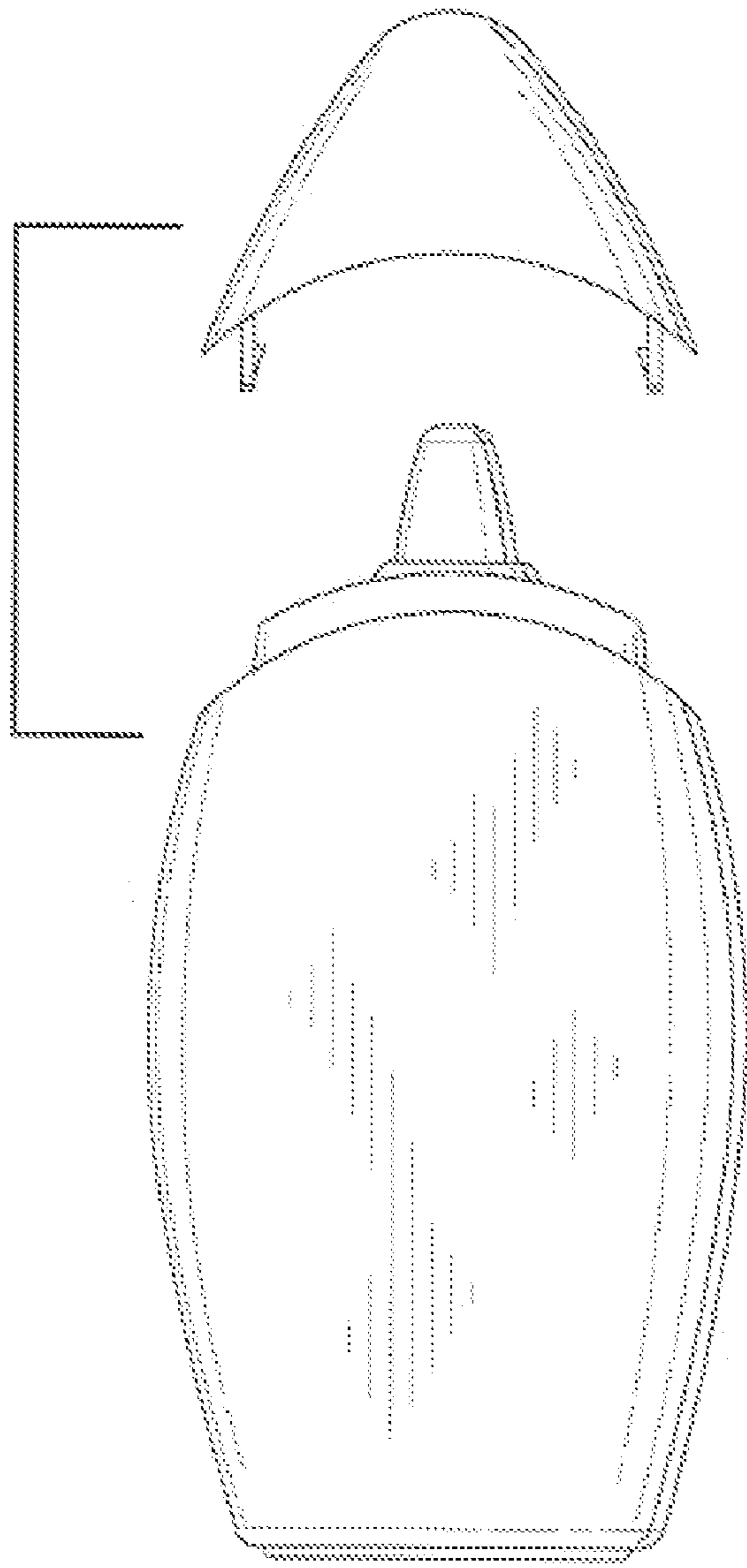

Fig. 13

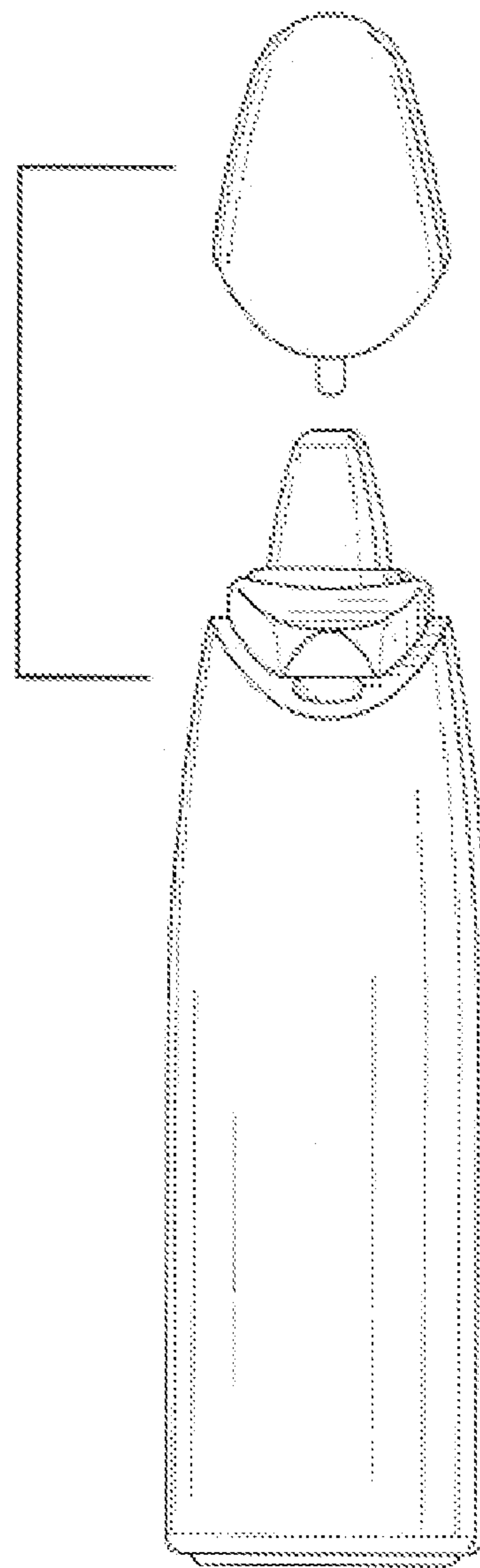

Fig. 14