



US00D552682S

(12) **United States Design Patent**
Rolion et al.

(10) **Patent No.:** **US D552,682 S**

(45) **Date of Patent:** **** Oct. 9, 2007**

(54) **ERASER FOR A WHITE BOARD**

(75) Inventors: **Franck Rolion**, Belloy en France (FR);
Juliette Bonnamour, Paris (FR);
Vincent Prigent, Paris (FR); **Vincent Bedhome**, Desvres (FR); **Didier Lange**,
Saint Leonard (FR)

(73) Assignee: **Societe BIC**, Clichy Cedex (FR)

(**) Term: **14 Years**

(21) Appl. No.: **29/229,294**

(22) Filed: **May 5, 2005**

(30) **Foreign Application Priority Data**

Nov. 9, 2004 (EM) 000251657-0001/2

(51) **LOC (8) Cl.** **19-06**

(52) **U.S. Cl.** **D19/53**

(58) **Field of Classification Search** D8/90;
D19/35, 53, 54; D32/40; 15/3.53, 104.92,
15/105.51, 105.52, 118, 210.1, 231, 424,
15/425, 427, 428, 429, 430, 433, 434, 435;
401/49, 52, 88; 451/523

See application file for complete search history.

(56) **References Cited**

U.S. PATENT DOCUMENTS

175,594 A * 4/1876 Burrington 76/40

D221,822 S * 9/1971 Kieves D4/137
D329,583 S * 9/1992 Medina D8/90
D366,670 S * 1/1996 Huh D19/53
D480,424 S * 10/2003 Belton et al. D19/53
2005/0115012 A1 * 6/2005 Wakat 15/210.1

* cited by examiner

Primary Examiner—Elizabeth A. Albert

(74) *Attorney, Agent, or Firm*—The H.T. Than Law Group

(57) **CLAIM**

The ornamental design for an eraser for a white board, as shown and described.

DESCRIPTION

FIG. 1 is a perspective view of an ornamental design for an eraser for a white board according to the present invention; FIG. 2 is a front elevational view thereof; FIG. 3 is a back elevational view thereof; FIG. 4 is a top plan view thereof; FIG. 5 is a bottom plan view thereof; FIG. 6 is a right side view thereof; and, FIG. 7 is a left side view thereof.

1 Claim, 7 Drawing Sheets

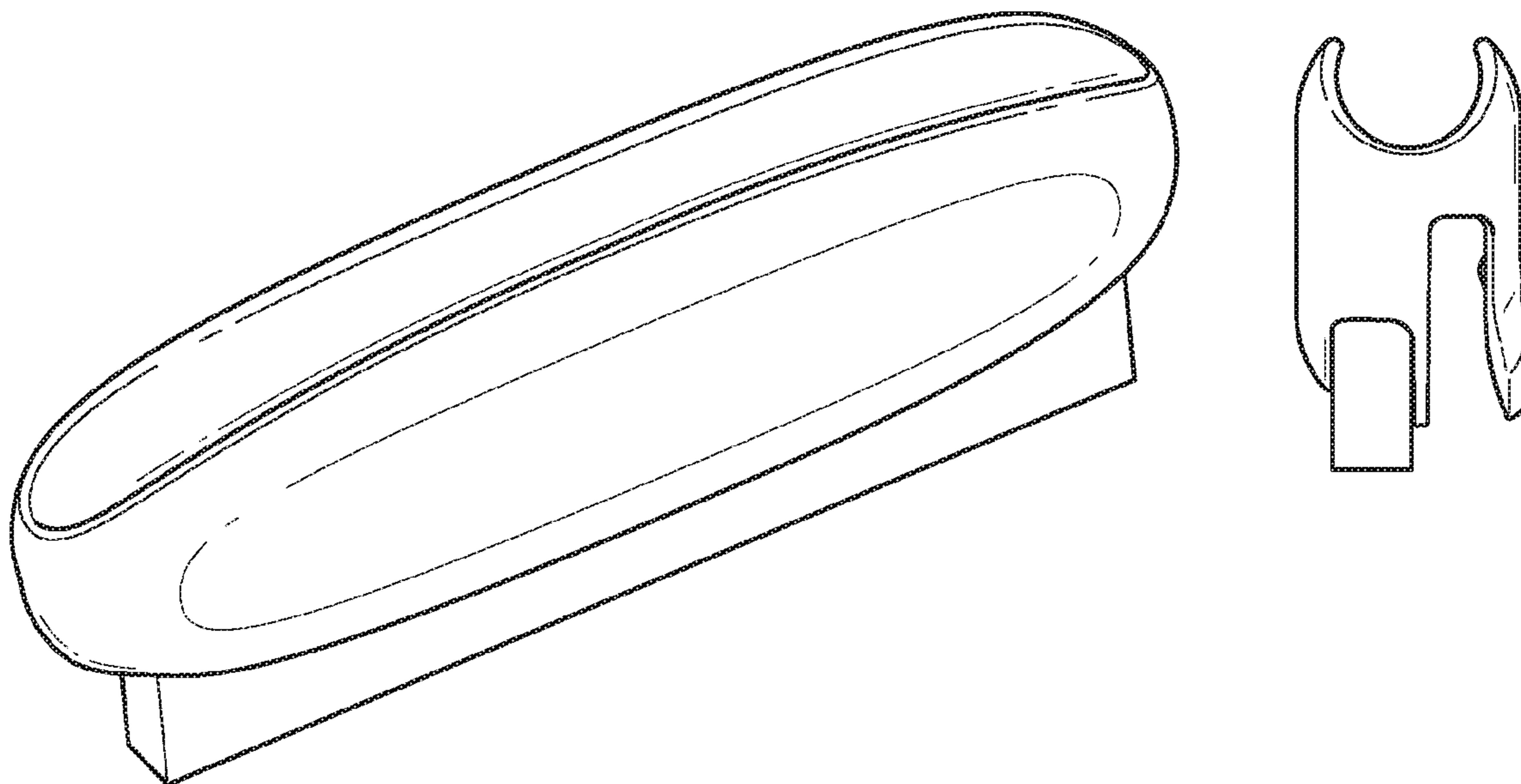

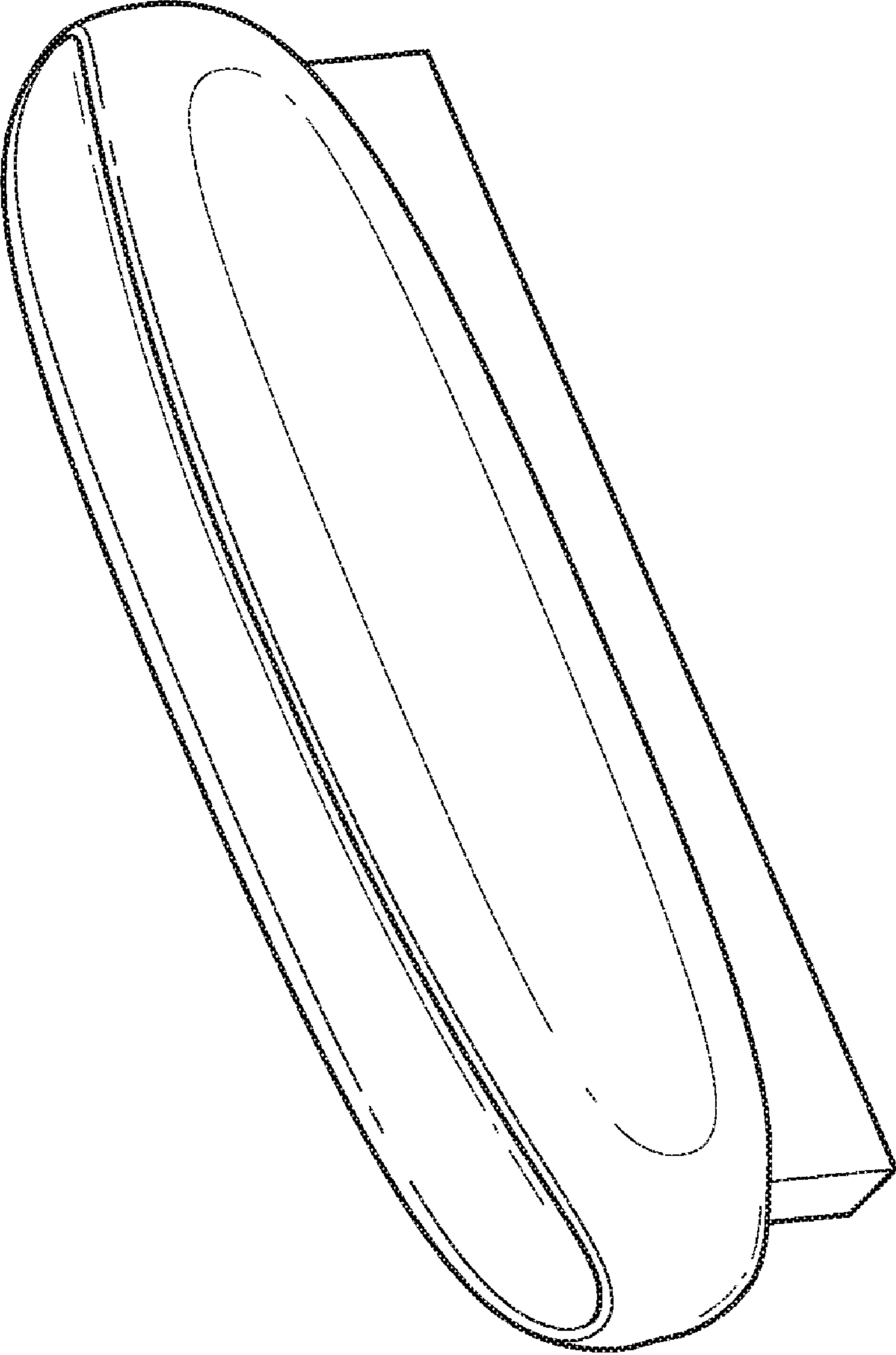

FIG. 1

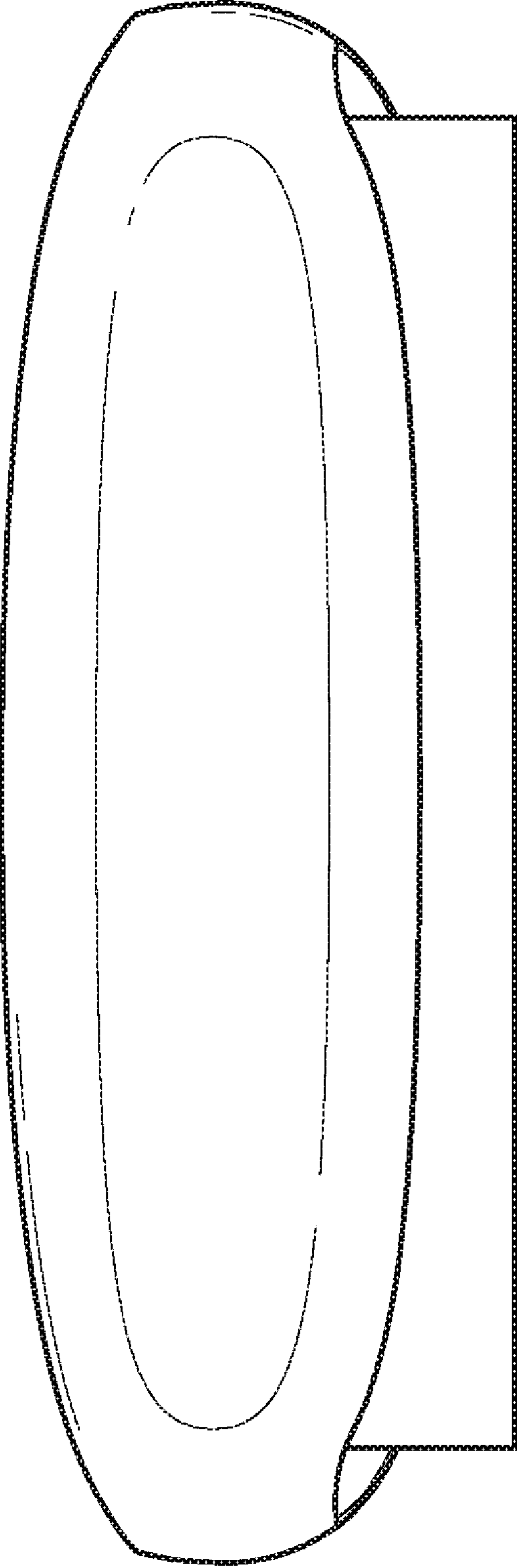

FIG. 2

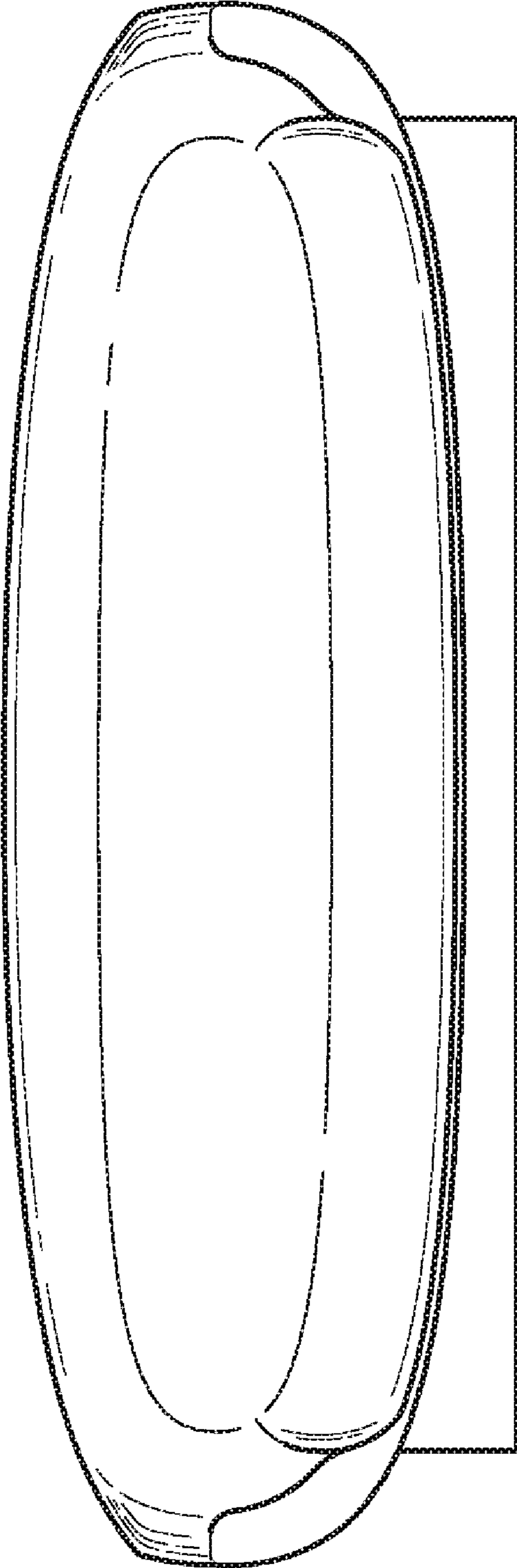

FIG. 3

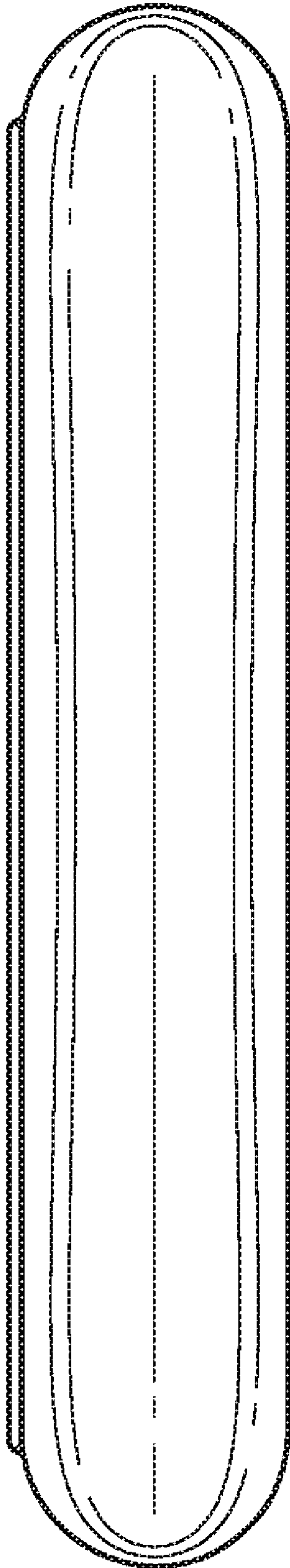

FIG. 4

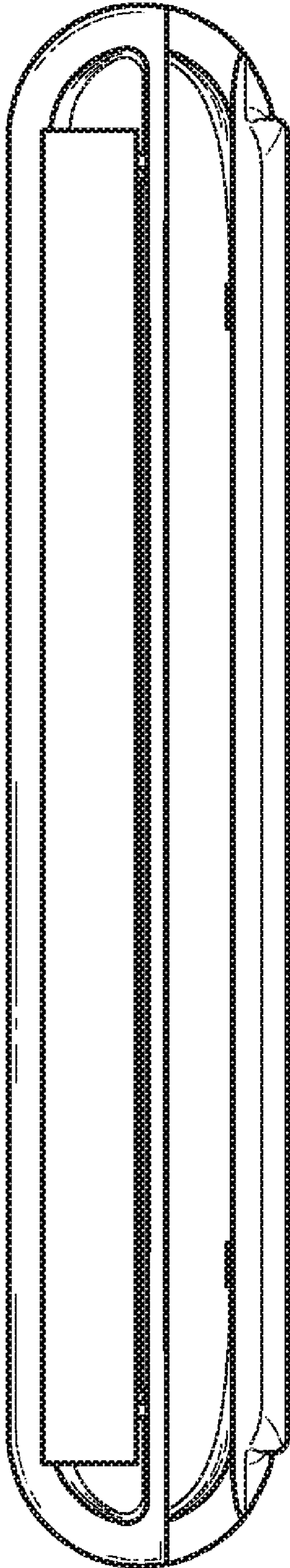

FIG. 5

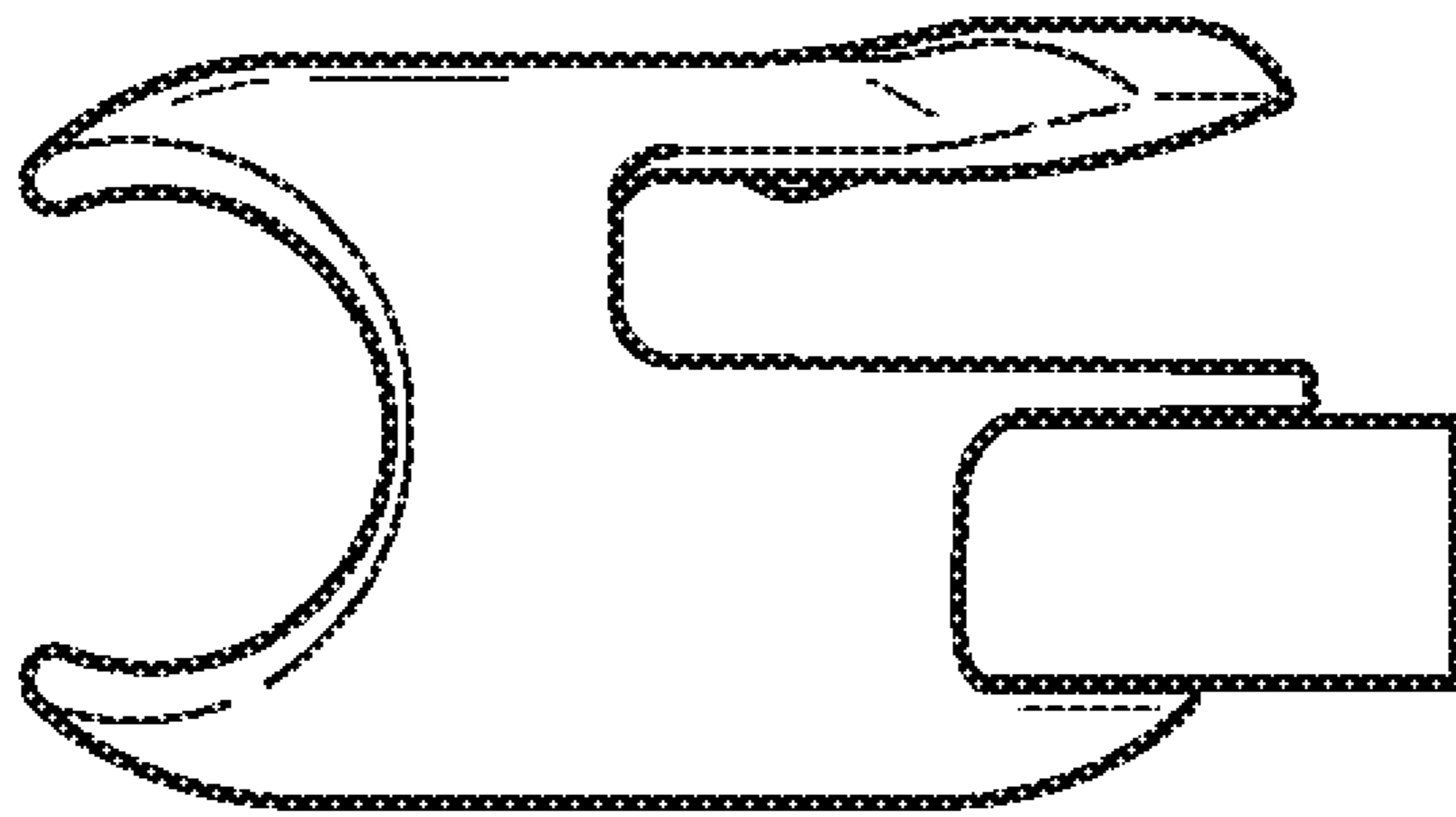

FIG. 6

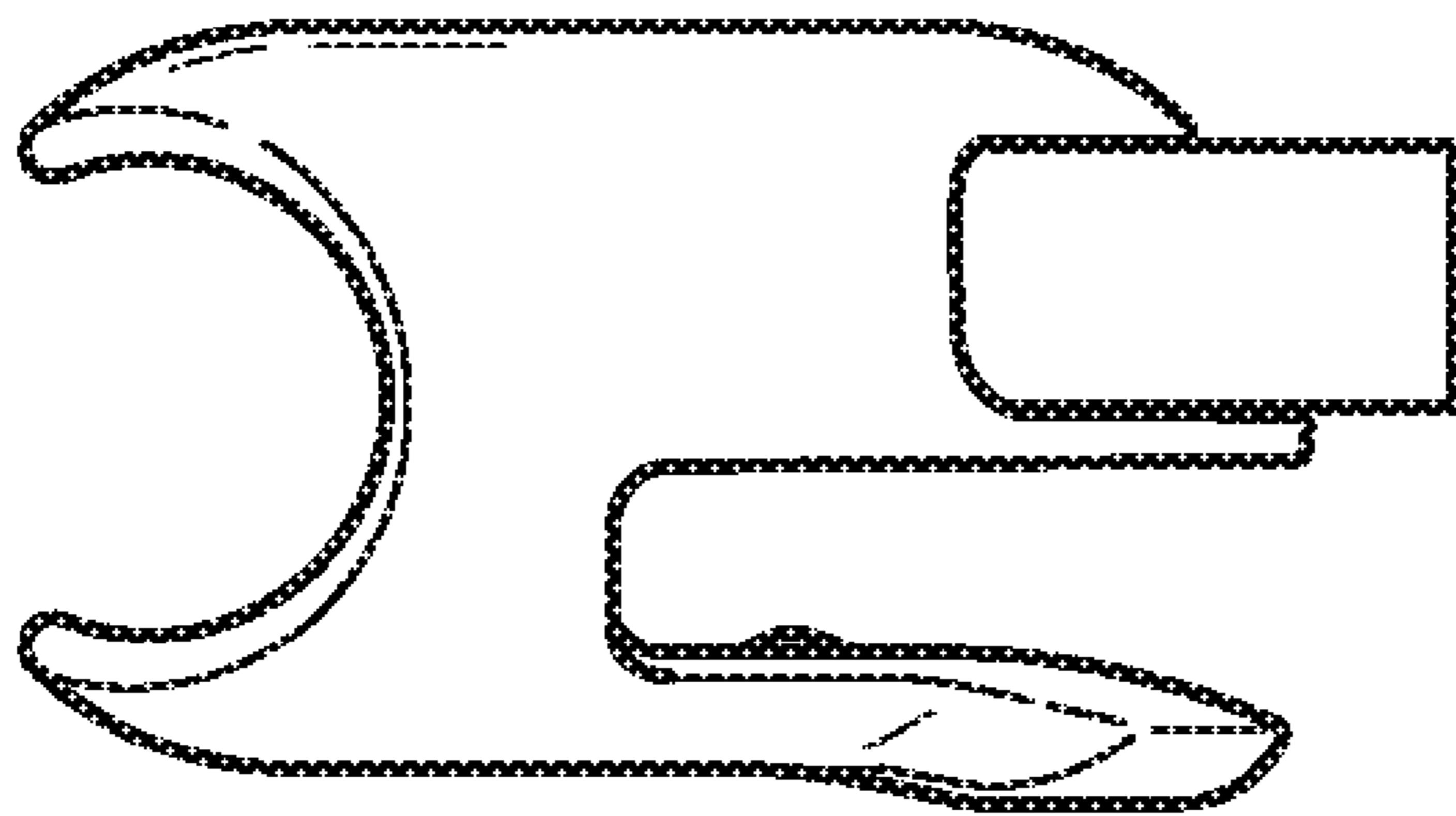

FIG. 7