



US00D552668S

(12) **United States Design Patent**
Hattori

(10) **Patent No.:** **US D552,668 S**

(45) **Date of Patent:** **** Oct. 9, 2007**

(54) **TAPE PRINTING MACHINE**

(75) Inventor: **Mitsuharu Hattori**, Nagoya (JP)

(73) Assignee: **Brother Industries, Ltd.**, Nagoya (JP)

(**) Term: **14 Years**

(21) Appl. No.: **29/255,173**

(22) Filed: **Mar. 7, 2006**

(30) **Foreign Application Priority Data**

Sep. 30, 2005 (JP) 2005-028611

(51) **LOC (8) Cl.** **18-02**

(52) **U.S. Cl.** **D18/19**

(58) **Field of Classification Search** D18/50,
D18/52, 53, 54, 56, 14, 18, 19; D14/399;
D13/164, 168; 400/613, 613.1-613.4, 691-694;
101/93.4, 269; 355/78

See application file for complete search history.

(56) **References Cited**

U.S. PATENT DOCUMENTS

- D344,537 S * 2/1994 Tsuchida et al. D18/19
- D356,817 S * 3/1995 Onumata et al. D18/19
- D359,753 S * 6/1995 Salinas et al. D18/19
- D363,082 S * 10/1995 Watanabe et al. D18/19
- D410,674 S * 6/1999 Tanaka et al. D18/19

- D424,104 S * 5/2000 Rorke et al. D18/56
- D425,555 S * 5/2000 Bishop et al. D18/56
- D444,494 S * 7/2001 Shimoki et al. D18/19
- D457,912 S * 5/2002 Shigemura et al. D18/19
- D490,842 S * 6/2004 Kamiya et al. D18/19
- D503,190 S * 3/2005 Hattori D18/19
- D503,193 S * 3/2005 Hattori et al. D18/56

* cited by examiner

Primary Examiner—Charles A. Rademaker

(74) *Attorney, Agent, or Firm*—Oliff & Berridge, PLC

(57) **CLAIM**

The ornamental design for tape printing machine, as shown and described.

DESCRIPTION

FIG. 1 is a perspective view of a tape printing machine;
 FIG. 2 is a front view thereof;
 FIG. 3 is a top view thereof;
 FIG. 4 is a right side view thereof;
 FIG. 5 is a left side view thereof;
 FIG. 6 is a rear view thereof; and,
 FIG. 7 is a bottom view thereof.

The broken lines are for illustrative purposes only and form no part of the claimed design.

1 Claim, 4 Drawing Sheets

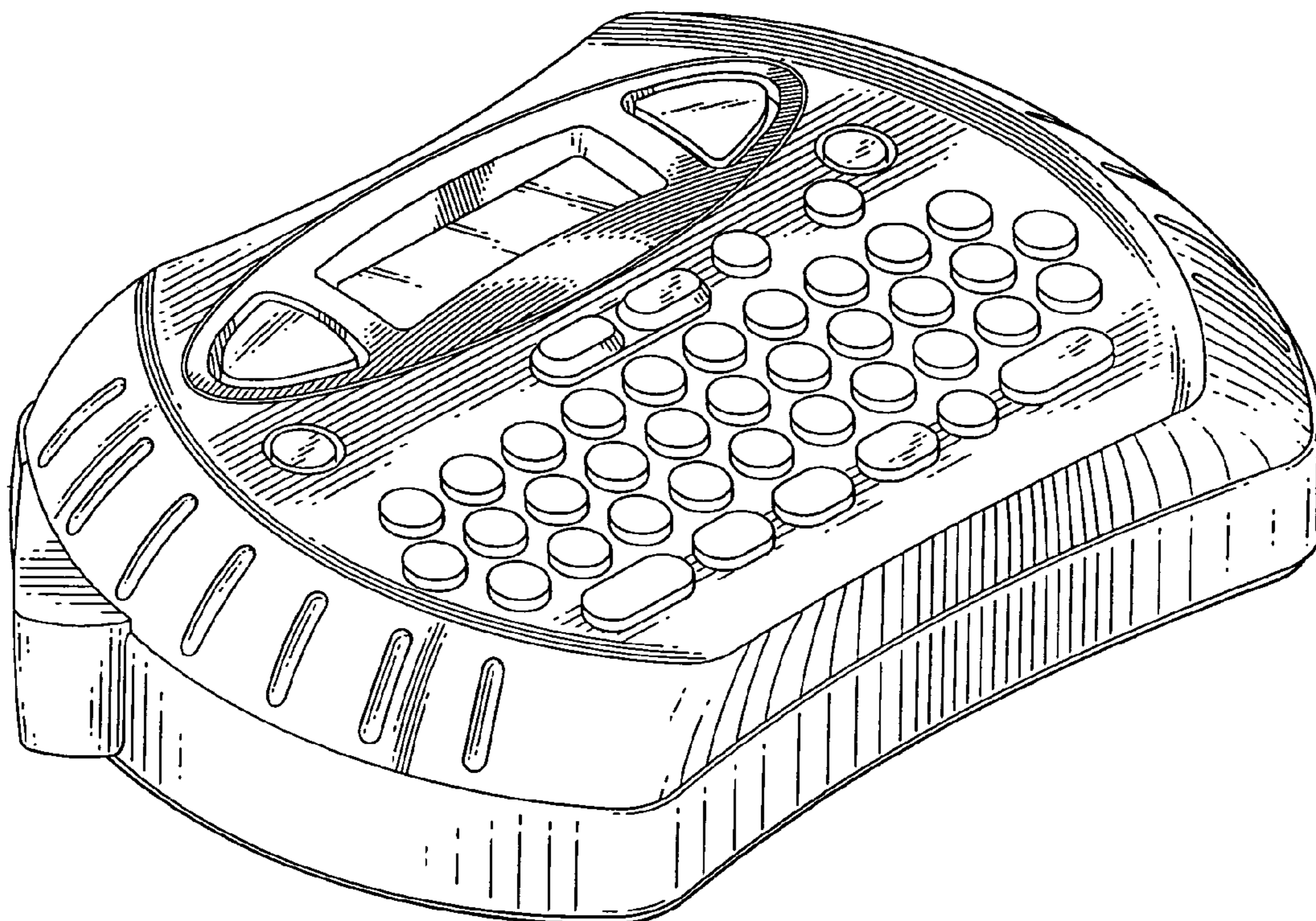

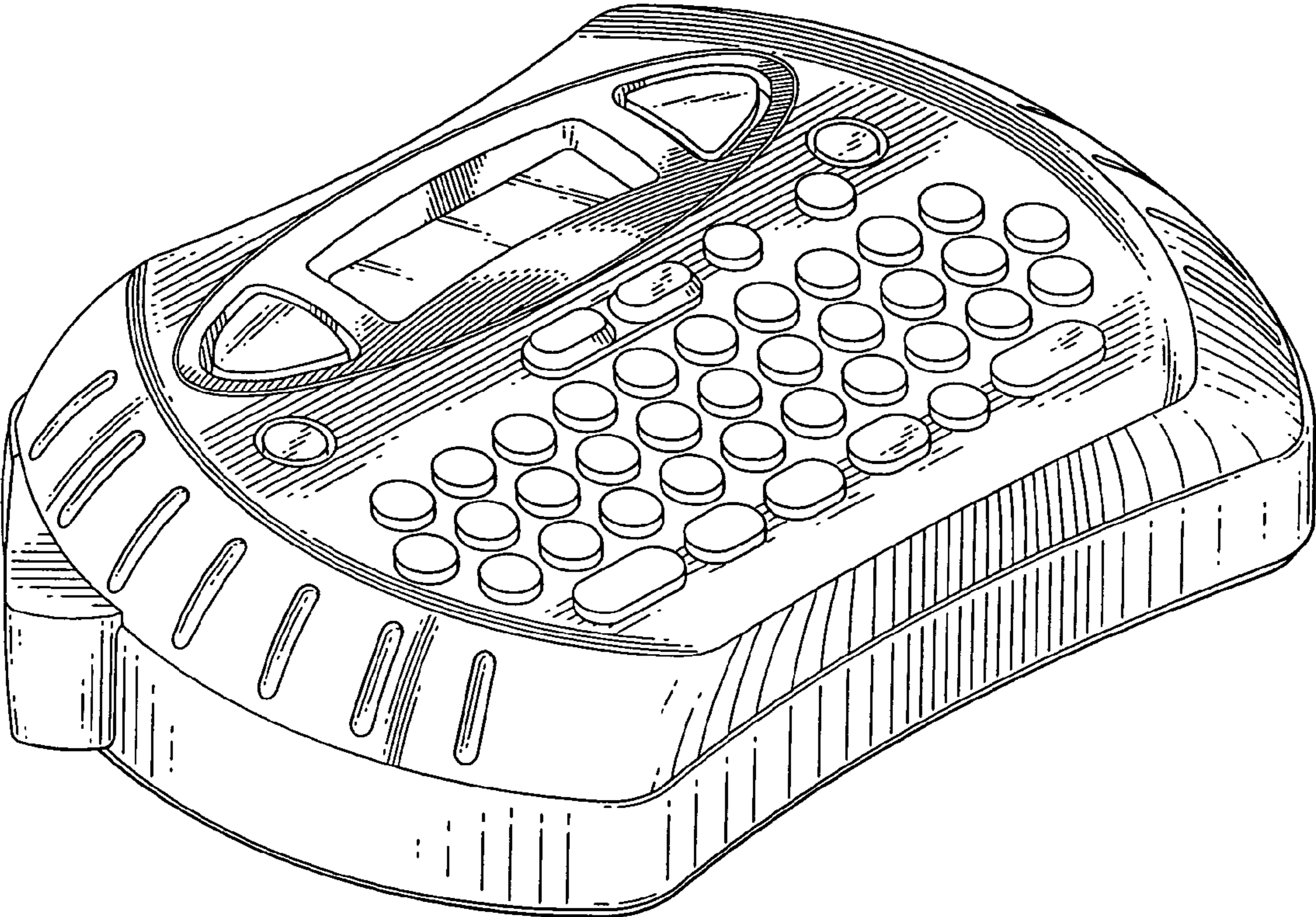

FIG. 1

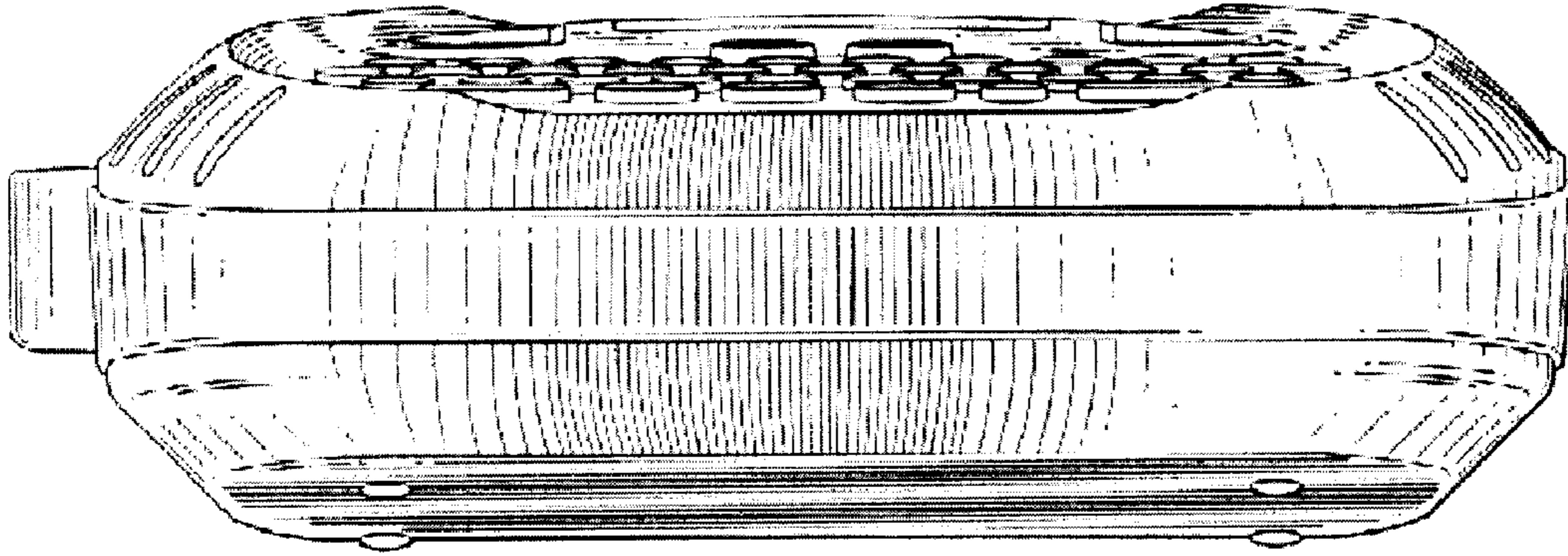

FIG. 2

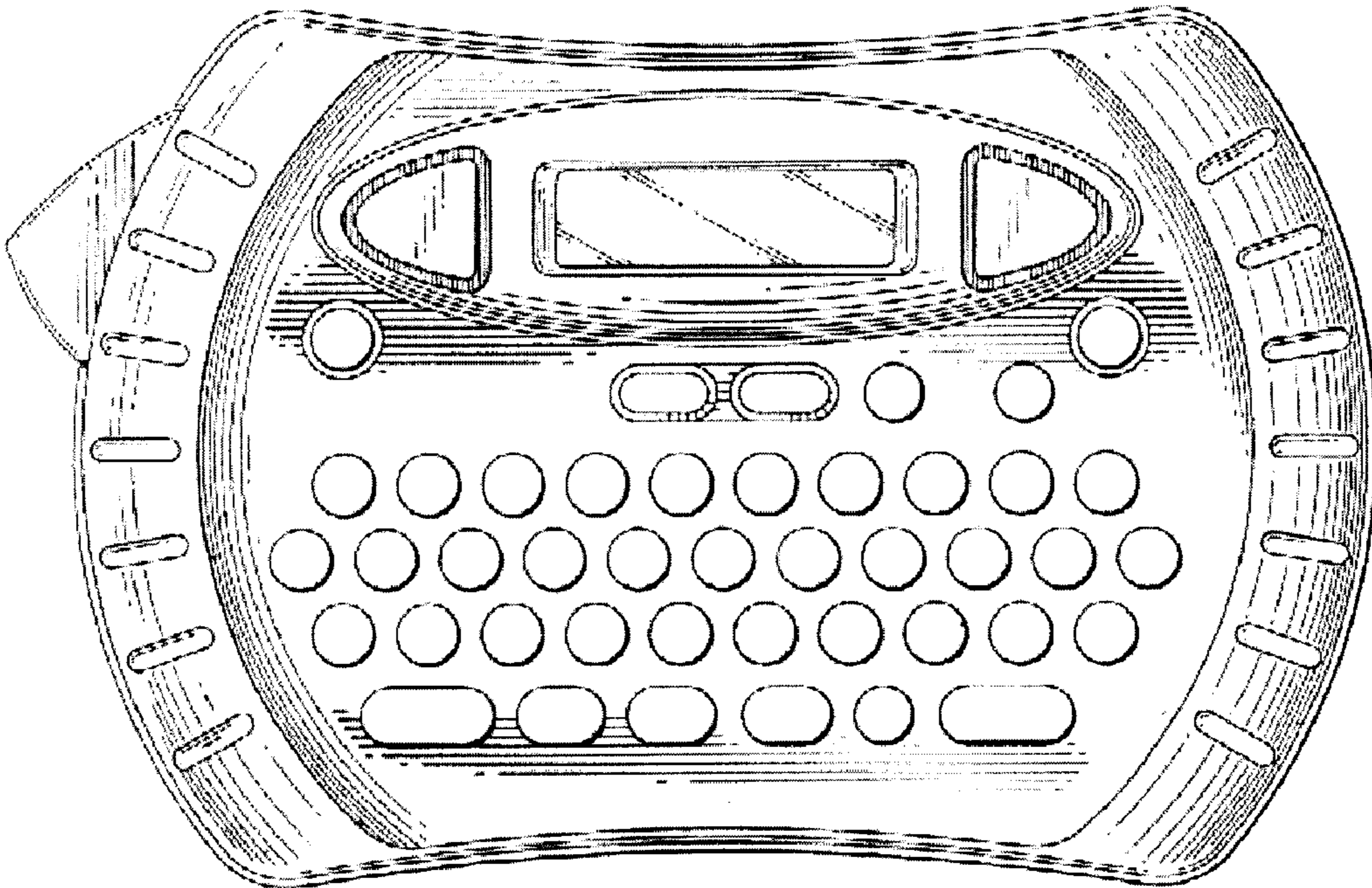

FIG. 3

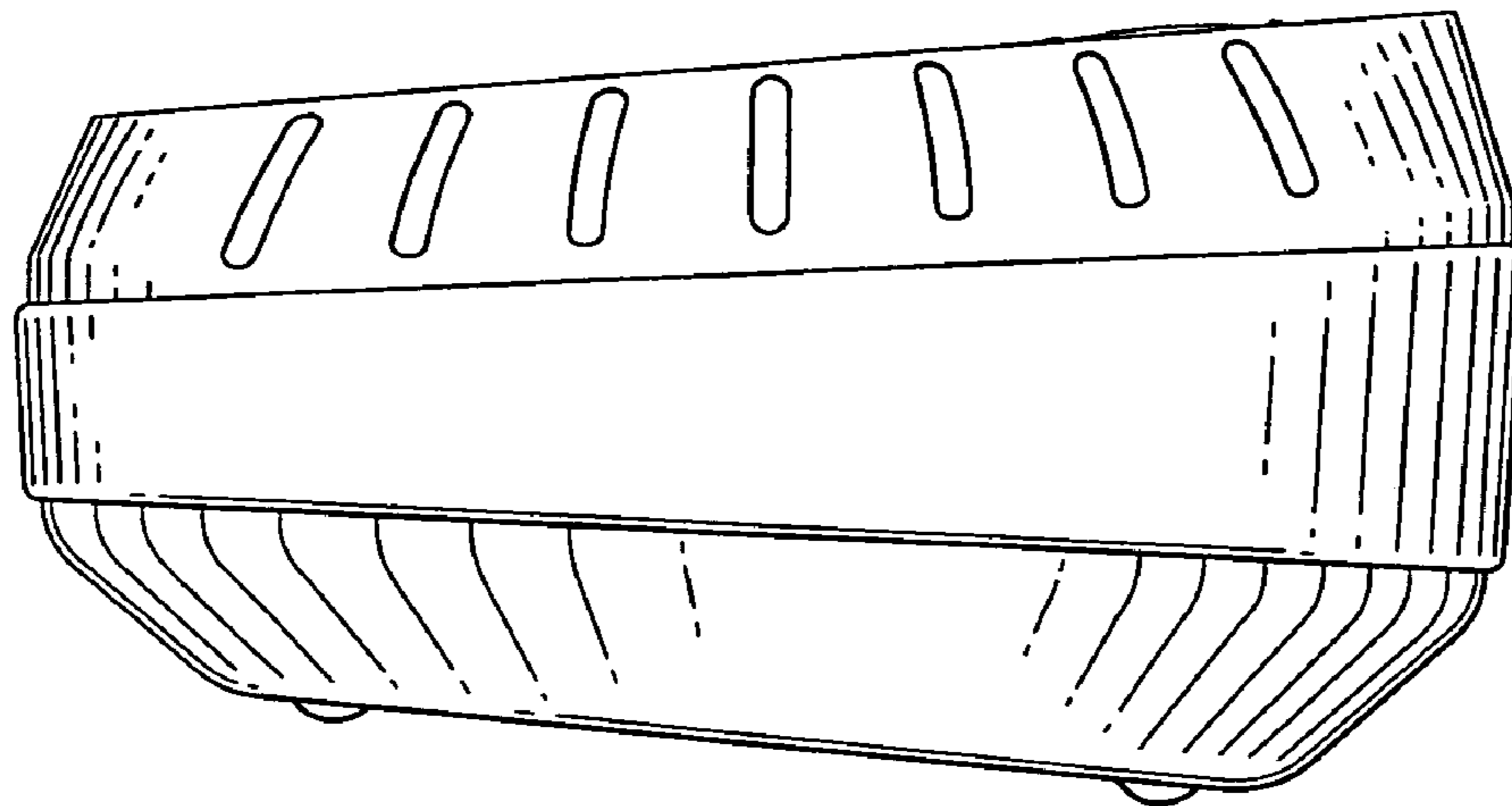

FIG. 4

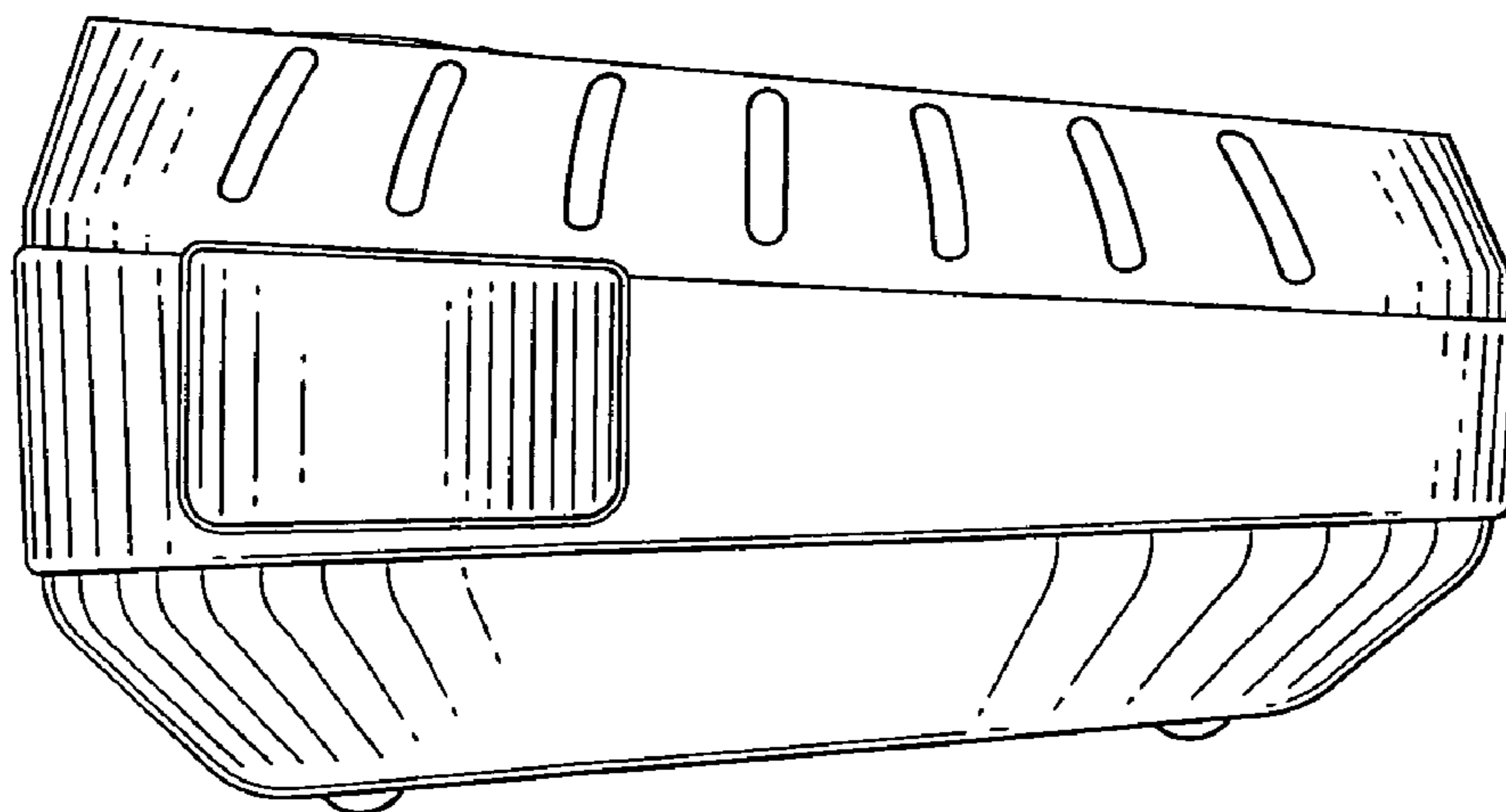

FIG. 5

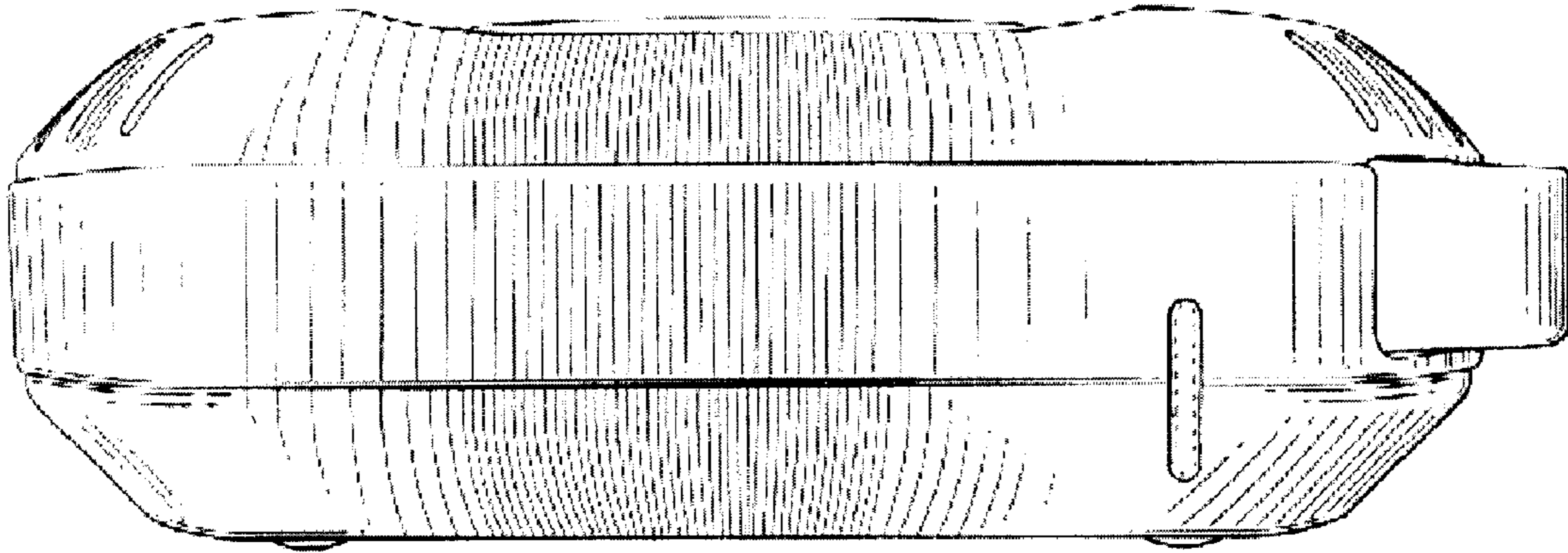

FIG. 6

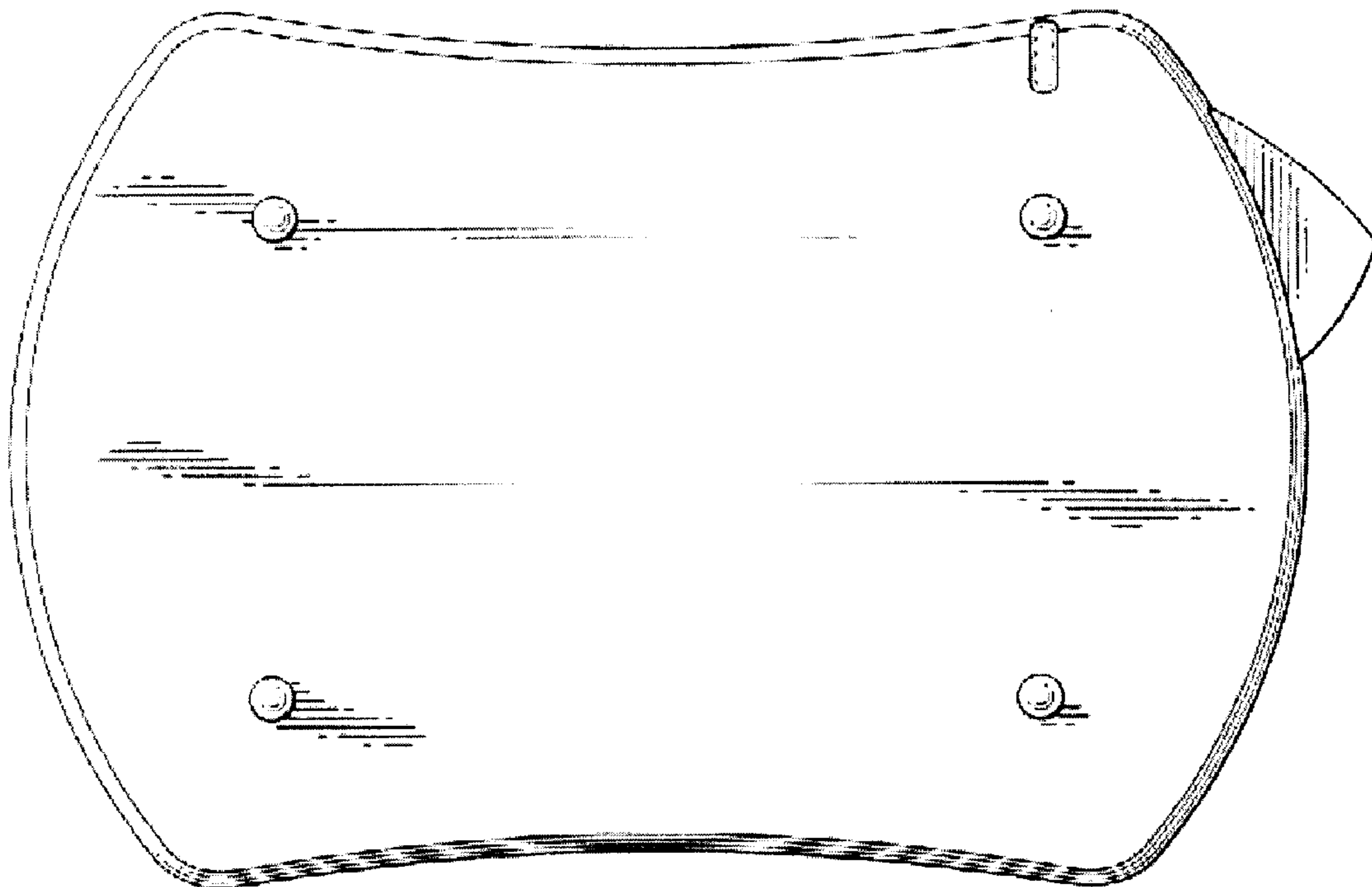

FIG. 7